



Schedule 80 CPVC Technical Information
Schedule 80 CPVC Pipe Dimensions & Pressure Ratings

Schedule 80 CPVC Pipe

Nominal Pipe Size (in)	O.D.	Average I.D.	Min. Wall	Nominal Wt./ft.	Maximum W.P. PSI*
1/8	0.405	0.195	0.095	0.068	1230
1/4	0.540	0.282	0.119	0.115	1130
3/8	0.675	0.403	0.126	0.158	920
1/2	0.840	0.526	0.147	0.232	850
3/4	1.050	0.722	0.154	0.314	690
1	1.315	0.936	0.179	0.461	630
1-1/4	1.660	1.255	0.191	0.638	520
1-1/2	1.900	1.476	0.200	0.773	470
2	2.375	1.913	0.218	1.070	400
2-1/2	2.875	2.29	0.276	1.632	420
3	3.500	2.864	0.300	2.186	370
4	4.500	3.786	0.337	3.196	320
6	6.625	5.709	0.432	6.102	280
8	8.625	7.565	0.500	9.269	250
10	10.750	9.493	0.593	13.744	230
12	12.750	11.294	0.687	18.909	230
14	14.000	12.41	0.750	22.681	220
16	16.000	14.213	0.843	29.162	220
18	18.000	16.014	0.937	36.487	220
20	20.000	17.814	1.031	44.648	220
24	24.000	21.418	1.218	63.341	210

Maximum CPVC Service Temperature 200°F

Pressure De-rating at Elevated Temperatures

The pressure ratings given above are for water, non-shock, @ 73°F. The specified derating factors for CPVC are suitable for pipe conveying water at elevated temperatures. To determine elevated temperature rating, multiply 73°F [23°C] pressure rating by appropriate factor shown in the table for desired operating temperature. When working near maximum specified temperature, solvent cement joints are recommended in place of threaded connections. Where disassembly is required at elevated temperatures use Spears® Special reinforced (SR) adapters, angles, unions or grooved coupling connections. Spears® recommends that only Schedule 80 or heavier wall thickness pipe should be threaded.

CPVC Pipe

Operating Temp (°F)	De-Rating Factor
73-80	1.00
90	0.91
100	0.82
110	0.72
120	0.65
130	0.57
140	0.50
150	0.42
160	0.40
170	0.29
180	0.25
200	0.20

EX: 2" CPVC SCHEDULE 80 @
 120°F = 400 psi x 0.65 = 260 psi max. @ 120°F

See Plastic Pipe Engineering Guide for additional information



Schedule 80 CPVC Fittings



TECHNICAL INFORMATION WEIGHTS & DIMENSIONS

Contact Spears® for any information not found.



CPVC Performance Engineered and Tested



SPEARS® Schedule 80 CPVC pipe and fitting designs combine years of proven experience with computer generated stress analysis to yield the optimum physical structure and performance for each fitting. Material reinforcement is uniformly placed in stress concentration areas for substantially improved pressure handling capability. Resulting products are subjected to numerous verification tests to assure the very best CPVC piping products available.

1/4" Through 24" Availability

Spears® comprehensive line of CPVC fittings offers a variety of configurations in Schedule 80 sizes 1/4" through 24".

Exceptional Chemical & Corrosion Resistance

Unlike metal, CPVC fittings never rust, scale or pit, and will provide many years of maintenance-free service and extended system life.

Higher Temperature Ratings

High Temperature CPVC Thermoplastics can handle fluids at service temperatures up to 200°F, allowing a wide range of process applications, including hot corrosive liquids.

Higher Flow Capacity

Smooth interior walls result in lower pressure loss and higher volume than conventional metal fittings.

Lower Installation Costs

Substantially lower material costs than steel alloys or lined steel, combined with lighter weight and ease of installation, can reduce installation costs by as much as 60% over conventional metal systems.

SPEARS® Schedule 80 14" Through 24" Fittings & Flanges

Schedule 80 CPVC 14" through 24" fittings are a special engineered product by Spears® Manufacturing Company, where no applicable ASTM specifications exist. Available in a variety of injection molded and fabricated configurations including Flanges, Couplings, Elbows, Bushings and Tees, plus custom fabrication to virtually any configuration.

1/8" Through 24" Industrial Pipe Availability

Spears® premium quality Industrial CPVC pipe is offered in Schedule 80 sizes 1/8" through 24". Schedule 40 CPVC pipe is also available.

American Bureau of Shipping (ABS) Type Approval

Spears® Schedule 40 and Schedule 80 CPVC pipe and fittings are ABS Type Approved for marine and offshore applications in nominal pipe sizes through 12". Type Approval details and restrictions are specified in ABS Certificate # 10-HS539421-1-PDA available on the ABS website at www.eagle.org.

CPVC Sample Engineering Specifications

All CPVC Schedule 80 fittings shall be produced by Spears® Manufacturing Company from CPVC materials, cell classification 23447 conforming to ASTM Standard D 1784. All injection molded fittings through 12" shall be manufactured in compliance to ASTM F 439 and all pipe through 16" shall be manufactured in compliance to ASTM F 441. Pipe and fittings shall be Certified by NSF International for use with potable water service. All 14" through 24" and fabricated fittings shall be produced in accordance with Spears® Specifications. All CPVC flanges shall be designed and manufactured to meet CL150 bolt pattern per ANSI Standard B16.5.



The information contained in this publication is based on current information and Product design at the time of publication and is subject to change without notification. Our ongoing commitment to product improvement may result in some variation. No representations, guarantees or warranties of any kind are made as to its accuracy, suitability for particular applications or results to be obtained therefrom. For verification of technical data or additional information not contained herein, please contact Spears® Technical Services Department [West Coast: (818) 364-1611 — East Coast: (678) 985-1263].

General Information

Recommendations For Installers And Users

Plastic piping systems should be **ENGINEERED, INSTALLED** and **OPERATED** in accordance with **ESTABLISHED DESIGN AND ENGINEERING STANDARDS AND PROCEDURES** for plastic piping systems. Suitability for the intended service application should be determined by the installer and/or user prior to installation of a plastic piping system. **PRIOR TO ASSEMBLY, all piping system components should be inspected for damage or irregularities. Mating components should be checked to assure that tolerances and engagements are compatible. Do not use any components that appear irregular or do not fit properly. Contact the appropriate manufacturer of the component product in question to determine usability. Consult all applicable codes and regulations for compliance prior to installation.**

Solvent Weld Connections — Use quality solvent cements and primers formulated for the intended service application, pipe size and type of joint. While the pipe and fitting materials may be compatible with the intended medium, the solvent cement may not be. Consult the manufacturers for suitability of use. Read and follow the cement and primer manufacturers' applications and cure time instructions thoroughly. Be sure to use the correct size applicator.

Threaded Connections — Use a quality grade thread sealant. **WARNING: SOME PIPE JOINT COMPOUNDS OR PTFE PASTES MAY CONTAIN SUBSTANCES THAT COULD CAUSE STRESS CRACKING TO PLASTIC.** Spears® Manufacturing company recommends the use of Spears® **BLUE 75™** Thread Sealant which has been tested for compatibility with Spears® products. Please follow the sealant manufacturers' application/installation instructions. Choice of an appropriate thread sealant other than those listed above is at the discretion of the installer. 1 to 2 turns beyond **FINGER TIGHT** is generally all that is required to make a sound plastic threaded connection. Unnecessary **OVERTIGHTENING** will cause **DAMAGE TO BOTH PIPE AND FITTING.**



Standards and Specifications

Molded Schedule 80 CPVC products are manufactured to ASTM F 439 for use with pipe manufactured to ASTM F 441. Certain products carry reduced pressure handling capability and have maximum internal pressure ratings at 73°F noted.

Schedule 80 CPVC fabricated fittings for use with pipe manufactured to ASTM F 441. See publication FAB-7, General Specifications for Standard Fabricated Fittings for additional information.

All specified Schedule 80 CPVC products are manufactured from materials certified by NSF® for use in potable water service.

"Lead Free" low lead certification – unless otherwise specified, all Spears® Schedule 80 fittings specified here-in are certified by NSF International to ANSI/NSF® Standard 61, Annex G and is in compliance with California's Health & Safety Code Section 116825 (commonly known as AB1953) and Vermont Act 193. Weighted average lead content $\leq 0.25\%$. Spears® PVC and CPVC Pipe, Fittings and Valves have always been lead-free and Certified by NSF International for use in potable water systems. Spears® offers a wide range of lead-free specialty fittings and transition adapters for plumbing applications. However, certain brass threaded adapter fittings for applications that are not intended to convey water for human consumption through drinking or cooking are still produced and available.



Schedule 80 CPVC Technical Information
Schedule 80 CPVC Fittings

ASTM STANDARD DIMENSIONS

**SCHEDULE 80 PIPE DIMENSIONS
ASTM D 1785**

Nominal Pipe Size In.	Mean Outside Diameter In.	O. D. Tolerance In.	Minimum Wall Thickness In.
1/8	0.405	± 0.004	0.095
1/4	0.540	± 0.004	0.119
3/8	0.675	± 0.004	0.126
1/2	0.840	± 0.004	0.147
3/4	1.050	± 0.004	0.154
1	1.315	± 0.005	0.179
1-1/4	1.660	± 0.005	0.191
1-1/2	1.900	± 0.006	0.200
2	2.375	± 0.006	0.218
2-1/2	2.875	± 0.007	0.276
3	3.500	± 0.008	0.300
4	4.500	± 0.009	0.337
5	5.563	± 0.010	0.375
6	6.625	± 0.011	0.432
8	8.625	± 0.015	0.500
10	10.750	± 0.015	0.593
12	12.750	± 0.015	0.687

**SCHEDULE 80 SOCKET DIMENSIONS
ASTM D 2467**

Nominal Size In.	Diameter			Socket Length Minimum C
	Entrance A	Bottom B	Tolerance A	
1/8	0.417	0.401	± 0.004	0.500
1/4	0.552	0.536	± 0.004	0.625
3/8	0.687	0.671	± 0.004	0.750
1/2	0.848	0.836	± 0.004	0.875
3/4	1.058	1.046	± 0.004	1.000
1	1.325	1.310	± 0.005	1.125
1-1/4	1.670	1.655	± 0.005	1.250
1-1/2	1.912	1.894	± 0.006	1.375
2	2.387	2.369	± 0.006	1.500
2-1/2	2.889	2.868	± 0.007	1.750
3	3.516	3.492	± 0.008	1.875
4	4.518	4.491	± 0.009	2.250
5	5.583	5.553	± 0.010	2.625
6	6.647	6.614	± 0.011	3.000
8	8.655	8.610	± 0.015	4.000
10	10.780	10.735	± 0.015	5.000
12	12.780	12.735	± 0.015	6.000
14	14.030	13.985	± 0.015	7.000

**AMERICAN NATIONAL STANDARD
TAPER PIPE THREADS (NPT) ANSI
B1 .20.1 ASTM F 1498**

Nominal Size In.	Threads Per Inch	Effective Thread Length L	Pitch Of Thread P
1/8	27	0.2639	0.03704
1/4	18	0.4018	0.05556
3/8	18	0.4078	0.05556
1/2	14	0.5337	0.07143
3/4	14	0.5457	0.07143
1	11-1/2	0.6828	0.08696
1-1/4	11-1/2	0.7068	0.08696
1-1/2	11-1/2	0.7235	0.08696
2	11-1/2	0.7565	0.08696
2-1/2	8	1.1375	0.12500
3	8	1.2000	0.12500
4	8	1.3000	0.12500
5	8	1.4063	0.12500
6	8	1.5125	0.12500
8	8	1.7125	0.12500

STANDARD COMPARISONS

SPEARS® IPS-to-Metric transition unions are listed by nominal size. The chart below compares nominal and actual* pipe O.D. for each size according to the designated standard.

JIS K6741 (mm)		DIN 8062 (mm)		ASTM D1785 (in.)		NPT—ANSI B1.20.1** Tapered Thread		BSP—BS21, DIN 2999, ISO 7/1 Thread	
Nominal	Actual*	O.D.	Actual*	Nominal	Actual*	Designation	Threads/in.	Designation	Threads/25.4mm
16	22	15	20	1/2	.840	1/2	14	1/2	14
20	26	20	25	3/4	1.050	3/4	14	3/4	14
25	32	25	32	1	1.315	1	11.5	1	11
30	38	38	40	1-1/4	1.660	1-1/4	11.5	1-1/4	11
40	48	40	50	1-1/2	1.900	1-1/2	11.5	1-1/2	11
50	60	50	63	2	2.375	2	11.5	2	11
75	89	80	90	3	3.500	3	8	3	11
100	114	100	110	4	4.500	4	8	4	11

*Specified dimension, certain tolerances apply

**NPT and BSP have different thread angles and not compatible.

Schedule 80 CPVC Technical Information
Schedule 80 CPVC Fittings



Injection Molded Dimensions References:

- G** = (LAYING LENGTH) intersection of center lines to bottom of socket/thread; 90° elbows, tees, crosses; ± 1/32 inch.
- H** = Intersection of center lines to face of fitting; 90° elbow tees, crosses; ± 1/32 inch.
- J** = Intersection of center lines to bottom of socket/thread; 45° elbows; ± 1/32 inch

- L** = Overall length of fittings; ± 1/16 inch.
- H** = Outside diameter of socket/thread hub; ± 1/16 inch.
- N** = Socket bottom to socket bottom; couplings; ± 1/16 inch
- W** = Height of cap; ± 1/16 inch.

Fabricated Dimension References:

- G** = (LAYING LENGTH) intersection of center lines to bottom of socket/thread; 90° elbows, tees, crosses ± 1/4 inch; 14" & larger ± 1/2 inch.
- H** = Intersection of center lines to face of fitting; 90° elbows ± 1/4 inch, 14" & larger ± 3/4 inch; wyes ± 1/2 inch; tees, crosses ± 1/4 inch; 14" & larger ± 1/2 inch.
- J** = Intersection of center lines to bottom of socket/thread; 45° elbows; ± 1/4 inch; 14" & larger ± 1/2 inch.

- L** = Overall length of fittings; ± 1/2 inch; 14" & larger ± 1 inch; wyes ± 1 inch.
- M** = Outside diameter of socket/thread hub; ± 1/4 inch.
- N** = Socket bottom to socket bottom; couplings; ± 1/2
- W** = Height of cap; ± 1/4 inch.

Typical Fabricated Dimension References

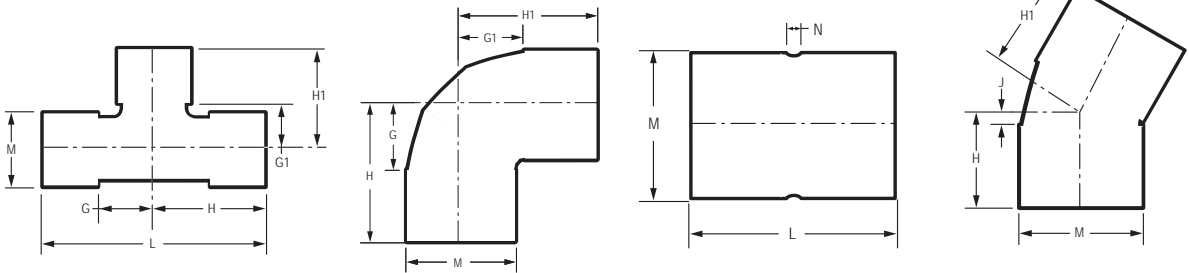

TEE

Socket x Socket x Socket

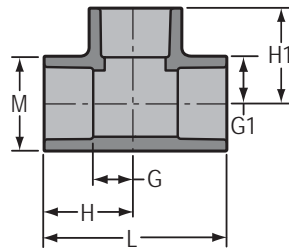

Part Number	Size	G	G1	H	H1	L	M	Approx. Wt. (Lbs.)
801-002C	1/4	5/16	5/16	31/32	31/32	1-15/16	27/32	.04
801-003C	3/8	15/32	15/32	1-1/4	1-1/4	2-1/2	31/32	.06
801-005C	1/2	19/32	19/32	1-15/32	1-15/32	2-15/16	1-3/16	.11
801-007C	3/4	21/32	21/32	1-11/16	1-11/16	3-13/32	1-13/32	.18
801-010C	1	27/32	27/32	2	2	3-31/32	1-23/32	.29
801-012C	1-1/4	1-1/32	1-1/32	2-9/32	2-9/32	4-19/32	2-3/32	.40
801-015C	1-1/2	1-3/16	1-3/16	2-9/32	2-9/32	5-1/8	2-3/8	.57
801-020C	2	1-7/16	1-7/16	2-15/16	2-15/16	5-7/8	2-7/8	.85
801-025C	2-1/2	1-23/32	1-23/32	3-1/2	3-1/2	7	3-15/32	1.62
801-030C	3	2-1/16	2-1/16	3-31/32	3-31/32	7-15/16	4-5/32	2.53
801-040C	4	2-1/2	2-1/2	4-3/4	4-3/4	9-1/2	5-1/4	3.72



Schedule 80 CPVC Technical Information
Schedule 80 CPVC Fittings

TEE (continued)

Socket x Socket x Socket

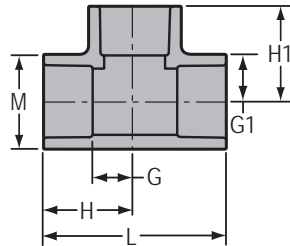

Part Number	Size	G	G1	H	H1	L	M	Approx. Wt. (Lbs.)
801-050C	5	3-1/8	3-1/8	5-25/32	5-25/32	11-5/8	6-13/32	6.47
801-050CF	5	5-1/2	5-1/2	8-1/2	8-1/2	17	6-5/16	18.38
801-060C	6	4-1/32	4-1/32	7-3/32	7-3/32	14-5/32	7-19/32	12.19
801-080C	8	4-13/16	4-13/16	8-7/8	8-7/8	17-3/4	9-23/32	21.53
801-080CF	8	7-5/8	7-5/8	11-7/8	11-7/8	23-3/4	9-5/8	30.91
801-100C	10	5-3/4	5-3/4	10-13/16	10-13/16	21-5/8	11-19/32	40.50
801-100CF	10	9	9	14-1/4	14-1/4	28-1/2	11-15/16	51.41
801-120C	12	6-15/16	6-15/16	12-15/16	12-15/16	25-7/8	14-1/4	62.00
801-120CF	12	11-1/4	11-1/4	17-1/2	17-1/2	35	14-1/8	83.37
801-140C	14	7-1/32	7-1/32	14-7/32	14-1/32	28-7/16	15-21/32	70.48
801-140CF	14	12-1/4	12-1/4	19-1/4	19-1/4	38-1/2	15-1/2	108.34
801-160CF	16	13	13	21	21	42	17-11/16	144.86
801-180CF	18	13-3/4	13-3/4	22-3/4	22-3/4	45-1/2	19-7/8	198.00
801-200CF	20	16-3/8	16-3/8	26-3/8	26-3/8	52-3/4	22-1/16	249.75
801-240CF	24	20-1/4	20-1/4	32-1/4	32-1/4	64-1/2	26-7/16	460.00

REDUCING TEE

Socket x Socket x Socket

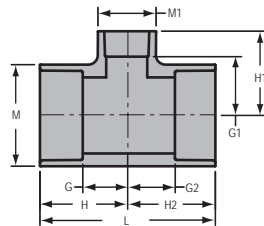

Part Number	Size	G	G1	G2	H	H1	H2	L	M	M1	Approx. Wt. (Lbs.)
801-101C	3/4x3/4x1/2	19/32	23/32	19/32	1-19/32	1-19/32	1-19/32	3-3/16	1-13/32	1-3/16	.15
801-130C	1x1x1/2	19/32	7/8	19/32	1-23/32	1-3/4	1-23/32	3-7/16	1-3/4	1-3/16	.21
801-131C	1x1x3/4	11/16	27/32	11/16	1-27/32	1-27/32	1-27/32	3-21/32	1-3/4	1-13/32	.24
801-158C	1-1/4x1x1	13/32	15/16	13/32	2-1/8	1-31/32	1-15/16	4	2-1/16	1-11/16	.34
801-159C	1-1/4x1x1-1/4	15/16	1-1/32	7/8	2-3/16	2-5/32	2-1/8	4-5/16	2-1/16	2-1/16	.41
801-166C ¹	1-1/4x1-1/4x1/2	7/8	1-13/32	7/8	2-3/32	2-3/8	2-3/32	4-7/32	2-1/8	1-3/4	.43
801-167C	1-1/4x1-1/4x3/4	5/8	31/32	5/8	1-15/16	1-31/32	1-15/16	3-7/8	2-1/8	1-13/32	.30
801-168C	1-1/4x1-1/4x1	27/32	1-1/32	27/32	2-3/32	2-5/32	2-3/32	4-7/32	2-3/32	1-3/4	.36

¹ Outlet sized with bushing

Schedule 80 CPVC Technical Information
Schedule 80 CPVC Fittings



REDUCING TEE

Socket x Socket x Socket

(continued)

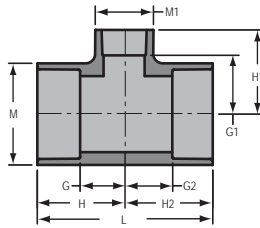

Part Number	Size	G	G1	G2	H	H1	H2	L	M	M1	Approx. Wt. (Lbs.)
801-202C	1-1/2x1-1/4x1	7/8	1-7/32	7/8	2-1/4	2-11/32	2-1/4	4-1/2	2-7/16	1-13/16	.42
801-209C	1-1/2x1-1/2x1/2	9/16	1-1/16	9/16	1-31/32	1-15/16	1-31/32	3-15/16	2-3/8	1-3/16	.36
801-210C	1-1/2x1-1/2x3/4	11/16	1-1/32	11/16	2-1/16	2-1/32	2-1/16	4-5/32	2-11/32	1-13/32	.39
801-211C	1-1/2x1-1/2x1	27/32	1-5/32	27/32	2-15/32	2-5/16	2-15/32	4-15/16	2-11/32	1-3/4	.43
801-212C	1-1/2x1-1/2x1-1/4	1-3/16	1-3/16	1-3/16	2-9/16	2-7/16	2-9/16	5-1/8	2-3/8	2-1/8	.57
801-247C	2x2x1/2	9/16	1-13/32	9/16	2-3/32	2-9/32	2-3/32	4-3/16	2-7/8	1-5/32	.46
801-248C	2x2x3/4	11/16	1-13/32	11/16	2-3/16	2-13/32	2-3/16	4-3/8	2-27/32	1-13/32	.52
801-249C	2x2x1	27/32	1-7/16	27/32	2-3/8	2-9/16	2-3/8	4-3/4	2-7/8	1-3/4	.59
801-250C	2x2x1-1/4	31/32	1-11/32	31/32	2-17/32	2-19/32	2-17/32	5-3/32	2-7/8	2-1/8	.64
801-251C	2x2x1-1/2	1-5/32	1-7/16	1-5/32	2-11/16	2-13/32	2-11/16	5-3/8	2-7/8	2-13/32	.80
801-254C ¹	2x2x4	3-11/16	2-15/32	3-11/16	5-3/16	4-23/32	5-3/16	10-11/32	5-1/4	5-1/4	5.54
801-287C	2-1/2x2-1/2x1/2	19/32	1-19/32	19/32	2-3/8	2-15/32	2-3/8	4-23/32	3-1/2	1-3/16	.78
801-288C	2-1/2x2-1/2x3/4	21/32	1-1/2	21/32	2-7/16	2-17/32	2-7/16	4-27/32	3-17/32	1-13/32	.83
801-289C	2-1/2x2-1/2x1	27/32	1-23/32	27/32	2-5/8	2-27/32	2-5/8	5-1/4	3-17/32	1-23/32	1.02
801-290C	2-1/2x2-1/2x1-1/4	1-1/16	1-23/32	1-1/16	2-27/32	2-31/32	2-27/32	5-11/16	3-9/16	2-3/32	1.16
801-291C	2-1/2x2-1/2x1-1/2	1-5/32	1-23/32	1-5/32	2-31/32	3-1/8	2-31/32	5-29/32	3-9/16	2-3/8	1.28
801-292C	2-1/2x2-1/2x2	1-13/32	1-5/8	1-13/32	3-3/16	3-1/8	3-3/16	6-3/8	3-1/2	2-7/8	1.37
801-333C ¹	3x3x1/2	1-7/16	2-7/8	1-7/16	3-5/16	3-3/4	3-5/16	6-5/8	4-3/16	2-7/8	2.07
801-334C ¹	3x3x3/4	1-7/16	2-11/16	1-7/16	3-5/16	3-11/16	3-5/16	6-5/8	4-3/16	2-7/8	2.05
801-335C	3x3x1	27/32	1-31/32	27/32	2-3/4	3-3/32	2-3/4	5-15/32	4-7/32	1-23/32	1.29
801-336C ¹	3x3x1-1/4	1-5/8	1-15/16	1-5/8	3-5/16	3-5/8	3-5/16	6-5/8	4-3/16	2-7/8	1.97
801-337C	3x3x1-1/2	1-5/32	2-1/16	1-5/32	3-1/16	3-7/16	3-1/16	6-1/8	4-3/16	2-3/8	1.49
801-338C	3x3x2	1-7/16	1-13/16	1-7/16	3-5/16	3-5/16	3-5/16	6-5/8	4-7/32	2-7/8	1.69
801-339C	3x3x2-1/2	1-3/4	1-31/32	1-3/4	3-5/8	3-11/16	3-5/8	7-1/4	4-3/16	3-17/32	2.11
801-415C ¹	4x4x1/2	1-7/16	3-17/32	1-7/16	3-11/16	4-13/32	3-11/16	7-11/32	5-1/4	2-7/8	2.72
801-417C ¹	4x4x1	1-15/32	3-9/32	1-15/32	3-11/16	4-3/8	3-11/16	7-3/8	5-7/32	2-7/8	2.87
801-418C ¹	4x4x1-1/4	1-1/8	2-31/32	1-1/8	3-13/32	4-7/32	3-13/32	6-25/32	5-1/4	2-3/8	2.63
801-419C	4x4x1-1/2	1-1/8	2-9/16	1-1/8	3-3/8	3-15/16	3-3/8	6-3/4	5-1/4	2-3/8	2.17
801-420C	4x4x2	1-7/16	2-1/2	1-7/16	3-11/16	4	3-11/16	7-3/8	5-1/4	2-7/8	2.42
801-421C ¹	4x4x2-1/2	2-1/16	2-11/16	2-1/16	4-5/16	4-3/4	4-5/16	8-5/8	5-1/4	4-1/8	3.68
801-422C	4x4x3	2-1/8	2-23/32	2-1/8	4-3/8	4-19/32	4-3/8	8-25/32	5-1/4	4-3/16	3.17
801-486C ¹	5x5x2	3-5/32	5-3/32	3-5/32	5-13/16	6-19/32	5-13/16	11-19/32	6-13/32	6-13/32	8.85
801-486CF	5x5x2	4-5/16	4-3/4	4-5/16	7-5/16	6-1/2	7-5/16	14-5/8	6-5/16	2-13/16	10.83
801-488C ¹	5x5x3	3-5/32	4-5/8	3-5/32	5-13/16	6-1/2	5-13/16	11-19/32	6-13/32	6-13/32	8.61
801-490C ¹	5x5x4	3-5/32	3-29/32	3-5/32	5-13/16	6-5/32	5-13/16	11-5/8	6-13/32	6-13/32	7.75

¹ Outlet sized with bushing





Schedule 80 CPVC Technical Information
Schedule 80 CPVC Fittings

REDUCING TEE (continued)

Socket x Socket x Socket

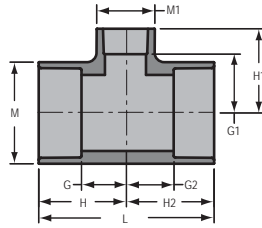

Part Number	Size	G	G1	G2	H	H1	H2	L	M	M1	Approx. Wt. (Lbs.)
801-524C ¹	6x6x3/4	1	4	1	3-7/8	5	3-7/8	7-3/4	7-9/16	1-3/4	4.48
801-525C	6x6x1	27/32	3-23/32	27/32	3-7/8	4-27/32	3-7/8	7-3/4	7-9/16	1-3/4	4.43
801-526C ¹	6x6x1-1/4	1-7/16	4-3/16	1-7/16	4-7/16	5-15/32	4-7/16	8-7/8	7-19/32	2-7/8	5.46
801-527C	6x6x1-1/2	1-7/16	4-3/32	1-7/16	4-7/16	5-1/2	4-7/16	8-7/8	7-19/32	2-7/8	7.16
801-528C	6x6x2	1-7/16	3-23/32	1-7/16	4-7/16	5-1/4	4-7/16	8-7/8	7-19/32	2-7/8	5.29
801-529C ¹	6x6x2-1/2	2-1/16	3-13/16	2-1/16	5-1/16	5-7/8	5-1/16	10-1/8	7-9/16	4-1/4	8.99
801-530C	6x6x3	2-1/16	3-3/4	2-1/16	5-3/32	5-5/8	5-3/32	10-3/16	7-19/32	4-1/4	---
801-530CF	6x6x3	4-3/4	5-3/4	4-3/4	8	8	8	16	7-1/2	4-1/8	11.74
801-532C	6x6x4	2-11/16	3-13/16	2-11/16	5-11/16	6-3/32	5-11/16	11-3/8	7-19/32	5-1/4	8.21
801-533CF	6x6x5	5-3/4	6-1/2	5-3/4	9	9-1/2	9	18	7-1/2	6-5/16	11.90
801-575C ¹	8x8x1	3-25/32	7-25/32	3-25/32	7-25/32	8-13/16	7-25/32	15-9/16	9-5/8	7-1/2	18.76
801-578C ¹	8x8x2	3-13/16	6-5/8	3-13/16	7-13/16	8-1/8	7-13/16	15-5/8	9-11/16	7-9/16	18.19
801-578CF	8x8x2	4-11/16	6-1/8	4-11/16	8-15/16	7-7/8	8-15/16	17-7/8	9-5/8	2-13/16	14.76
801-579CF	8x8x2-1/2	4-7/8	6-15/16	4-7/8	9-1/8	8-5/16	9-1/8	18-1/4	9-5/8	3-7/16	14.85
801-580C ¹	8x8x3	3-23/32	6-1/2	3-23/32	7-3/4	8-3/8	7-3/4	15-1/2	9-11/16	7-1/2	18.44
801-580CF	8x8x3	5-3/16	6-11/16	5-3/16	9-7/16	8-15/16	9-7/16	18-7/8	9-5/8	4-1/8	20.04
801-582C	8x8x4	2-5/8	4-27/32	2-5/8	6-5/8	7-3/32	6-5/8	13-1/4	9-3/4	5-1/4	11.60
801-582CF	8x8x4	2-5/8	4-27/32	2-5/8	6-5/8	7-3/32	6-5/8	13-1/4	9-3/4	5-1/4	11.60
801-585C	8x8x6	3-7/8	4-15/16	3-7/8	7-29/32	7-31/32	7-29/32	15-25/32	9-11/16	7-17/32	16.17
801-621CF	10x10x2	4-3/8	7-1/8	4-3/8	9-5/8	8-7/8	9-5/8	19-1/4	11-15/16	2-13/16	27.33
801-622CF	10x10x2-1/2	5-1/4	7-5/16	5-1/4	10-1/2	9-5/16	10-1/2	21	11-15/16	3-7/16	22.50
801-623C ¹	10x10x3	3-25/32	7-17/32	3-25/32	9-3/8	9-3/8	9-3/8	18-25/32	12-1/16	7-9/16	28.69
801-623CF	10x10x3	4-7/8	7-11/16	4-7/8	10-1/8	9-15/16	10-1/8	20-1/4	11-15/16	4-1/8	24.27
801-624C	10x10x4	3-7/8	7-3/16	3-7/8	9-3/8	9-1/2	9-3/8	18-3/4	12-1/16	7-9/16	28.54
801-624CF	10x10x4	5-3/8	8-11/16	5-3/8	10-5/8	10-15/16	10-5/8	21-1/4	11-15/16	5-3/16	26.65
801-626C	10x10x6	3-7/8	5-27/32	3-7/8	9-3/8	8-27/32	9-3/8	18-3/4	12-1/16	7-9/16	25.50
801-626CF	10x10x6	5-7/8	9-1/16	5-7/8	11-1/8	12-5/16	11-1/8	22-1/4	11-15/16	7-1/2	29.89
801-628C ¹	10x10x8	5-15/16	7-3/4	5-15/16	11-7/16	11-3/4	11-7/16	22-7/8	12-1/16	12-1/16	48.52
801-628CF	10x10x8	8-1/4	9-15/16	8-1/4	13-1/2	14-3/16	13-1/2	27	11-15/16	9-5/8	38.11
801-661CF	12x12x2	4-3/4	8	4-3/4	11	9-3/4	11	22	14-1/8	2-13/16	36.76
801-663CF	12x12x3	5-1/4	8-9/16	5-1/4	11-1/2	10-13/16	11-1/2	23	14-1/8	4-1/8	34.63
801-664C ¹	12x12x4	4-11/32	10-1/8	4-11/32	10-15/16	12-3/8	10-15/16	21-7/8	14-1/4	9-23/32	38.17
801-664CF	12x12x4	5-3/4	9-9/16	5-3/4	12	11-13/16	12	24	14-1/8	5-3/16	38.17
801-666CF	12x12x6	7-1/4	9-15/16	7-1/4	13-1/4	13-3/16	13-1/4	26-1/2	14-1/8	7-1/2	55.70
801-668C	12x12x8	4-27/32	7-1/2	4-27/32	11-13/32	11-1/8	11-13/32	22-13/16	14-1/4	9-23/32	42.00
801-668CF	12x12x8	8	10-13/16	8	14-1/4	15-1/16	14-1/4	28-1/2	14-1/8	9-5/8	66.12
801-670CF	12x12x10	10-1/4	10-13/16	10-1/4	16-1/2	16-1/16	16-1/2	33	14-1/8	11-15/16	70.97
801-691CF	14x14x2	5-3/16	8-9/16	5-3/16	12-3/16	10-5/16	12-3/16	24-3/8	15-1/2	2-13/16	44.73
801-692CF	14x14x2-1/2	5-7/16	8-3/4	5-7/16	12-7/16	10-3/4	12-7/16	24-7/8	15-1/2	3-7/16	45.01
801-693CF	14x14x3	5-3/4	9-1/8	5-3/4	12-3/4	11-3/8	12-3/4	25-1/2	15-1/2	4-1/8	56.80

¹ Outlet sized with bushing

Schedule 80 CPVC Technical Information
Schedule 80 CPVC Fittings



REDUCING TEE (continued)
 Socket x Socket x Socket

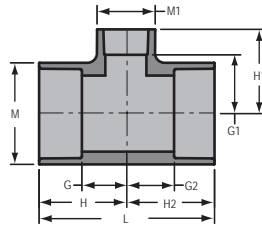

Part Number	Size	G	G1	G2	H	H1	H2	L	M	M1	Approx. Wt. (Lbs.)
801-694CF	14x14x4	6-1/2	10-1/8	6-1/2	13-1/2	12-3/8	13-1/2	27	15-1/2	5-3/16	50.00
801-696CF	14x14x6	8-1/4	10-1/2	8-1/4	15-1/4	13-3/4	15-1/4	30-1/2	15-1/2	7-1/2	63.15
801-698CF	14x14x8	9-1/4	11-3/8	9-1/4	16-1/4	15-5/8	16-1/4	32-1/2	15-1/2	9-5/8	68.17
801-700CF	14x14x10	10-1/8	11-3/8	10-1/8	17-1/8	16-5/8	17-1/8	34-1/4	15-1/2	11-15/16	89.80
801-702C	14x14x12	7-1/32	7-13/32	7-1/32	14-1/32	13-13/32	14-1/32	28-1/16	15-21/32	14-11/32	65.49
801-702CF	14x14x12	11	11-3/8	11	18	17-5/8	18	36	15-1/2	14-1/8	93.81
801-751CF	16x16x2	5-7/8	9-1/2	5-7/8	13-7/8	11-1/4	13-7/8	27-3/4	17-11/16	2-13/16	71.71
801-752CF	16x16x2-1/2	6	9-11/16	6	14	11-11/16	14	28	17-11/16	3-7/16	64.80
801-753CF	16x16x3	6-5/16	10-1/16	6-5/16	14-5/16	12-5/16	14-5/16	28-5/8	17-11/16	4-1/8	67.39
801-754CF	16x16x4	6-1/8	11-1/16	6-1/8	14-1/8	13-5/16	14-1/8	28-1/4	17-11/16	5-3/16	70.21
801-756CF	16x16x6	8-5/8	11-7/16	8-5/8	16-5/8	14-11/16	16-5/8	33-1/4	17-11/16	7-1/2	90.09
801-758CF	16x16x8	9-5/8	12-5/16	9-5/8	17-5/8	16-9/16	17-5/8	35-1/4	17-11/16	9-5/8	98.00
801-760CF	16x16x10	10-5/8	12-5/16	10-5/8	18-5/8	17-9/16	18-5/8	37-1/4	17-11/16	11-15/16	119.71
801-762CF	16x16x12	11-5/8	12-5/16	11-5/8	19-5/8	18-9/16	19-5/8	39-1/4	17-11/16	14-1/8	116.70
801-764CF	16x16x14	12-3/4	12-11/16	12-3/4	20-3/4	19-11/16	20-3/4	41-1/2	17-11/16	15-1/2	129.51
801-784CF	18x18x4	6-7/8	11-15/16	6-7/8	15-7/8	14-3/16	15-7/8	31-3/4	19-7/8	5-3/16	99.22
801-786CF	18x18x6	8-1/2	12-5/16	8-1/2	17-1/2	15-9/16	17-1/2	35	19-7/8	7-1/2	117.69
801-788CF	18x18x8	9-1/2	13-3/16	9-1/2	18-1/2	17-7/16	18-1/2	37	19-7/8	9-5/8	127.49
801-790CF	18x18x10	10-1/2	13-3/16	10-1/2	19-1/2	18-7/16	19-1/2	39	19-7/8	11-15/16	138.59
801-792CF	18x18x12	11-1/2	13-3/16	11-1/2	20-1/2	19-7/16	20-1/2	41	19-7/8	14-1/8	150.34
801-794CF	18x18x14	12-3/4	13-9/16	12-3/4	21-3/4	20-9/16	21-3/4	43-1/2	19-11/16	15-1/2	165.78
801-796CF	18x18x16	13-1/2	14-3/16	13-1/2	22-1/2	22-3/16	22-1/2	45	19-11/16	17-11/16	172.46
801-814CF	20x20x4	7-11/16	12-7/8	7-11/16	17-11/16	15-1/8	17-11/16	35-3/8	22-1/16	5-3/16	116.55
801-816CF	20x20x6	8-7/8	13-1/4	8-7/8	18-7/8	16-1/2	18-7/8	37-3/4	22-1/16	7-1/2	147.44
801-818CF	20x20x8	9-7/8	14-1/8	9-7/8	19-7/8	18-3/8	19-7/8	39-3/4	22-1/16	9-5/8	151.48
801-820CF	20x20x10	10-7/8	14-1/8	10-7/8	20-7/8	19-3/8	20-7/8	41-3/4	22-1/16	11-15/16	163.28
801-822CF	20x20x12	11-7/8	14-1/8	11-7/8	21-7/8	20-3/8	21-7/8	43-3/4	22-1/16	14-1/8	176.50
801-824CF	20x20x14	12-7/8	14-1/2	12-7/8	22-7/8	21-1/2	22-7/8	45-3/4	22-1/16	15-1/2	190.95
801-826CF	20x20x16	14	15-1/8	14	24	23-1/8	24	48	22-1/16	17-11/16	210.27
801-828CF	20x20x18	15	15	15	25	24	25	50	22-1/16	19-7/8	226.80
801-904CF	24x24x4	9	14-11/16	9	21	16-15/16	21	42	26-7/16	5-3/16	195.97
801-906CF	24x24x6	9-1/4	15-1/16	9-1/4	21-1/4	18-5/16	21-1/4	42-1/2	26-7/16	7-1/2	202.94
801-908CF	24x24x8	10-1/4	15-15/16	10-1/4	22-1/4	20-3/16	22-1/4	44-1/2	26-7/16	9-5/8	236.29
801-910CF	24x24x10	11-1/4	15-15/16	11-1/4	23-1/4	21-3/16	23-1/4	46-1/2	26-7/16	11-15/16	255.95
801-912CF	24x24x12	12-1/4	15-15/16	12-1/4	24-1/4	22-3/16	24-1/4	48-1/2	26-7/16	14-1/8	295.00
801-914CF	24x24x14	13-1/4	16-5/16	13-1/4	25-1/4	23-5/16	25-1/4	50-1/2	26-7/16	15-1/2	282.42
801-916CF	24x24x16	14-3/4	16-15/16	14-3/4	26-3/4	24-15/16	26-3/4	53-1/2	26-7/16	17-11/16	306.44
801-918CF	24x24x18	15-3/4	16-13/16	15-3/4	27-3/4	25-13/16	27-3/4	55-1/2	26-7/16	19-7/8	246.78
801-920CF	24x24x20	16-3/4	18-3/16	16-3/4	28-3/4	28-3/16	28-3/4	57-1/2	26-7/16	22-1/16	351.60





Schedule 80 CPVC Technical Information
Schedule 80 CPVC Fittings

TEE

Socket x Socket x Fipt

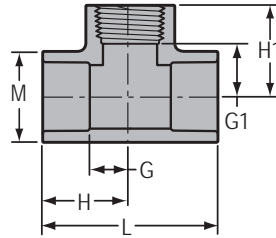

Part Number	Size	G	G1	H	H1	L	M	Approx. Wt. (Lbs.)
802-002C	1/4	5/16	3/8	15/16	15/16	1-29/32	7/8	.05
802-005C	1/2	19/32	21/32	1-15/32	1-11/32	2-15/16	1-3/16	.12
802-007C	3/4	5/8	5/8	1-19/32	1-13/32	3-3/16	1-13/32	.15
802-010C	1	11/16	3/4	1-13/16	1-5/8	3-13/16	1-13/16	.24
802-012C	1-1/4	13/16	1-1/16	2-3/32	1-15/16	4-5/32	2-3/32	.37
802-015C	1-1/2	29/32	1-1/4	2-11/32	2-5/32	4-11/16	2-3/8	.51
802-020C	2	1-9/32	1-15/32	2-13/16	2-13/32	5-21/32	2-7/8	.80
802-030C	3	1-31/32	2-1/8	3-3/4	3-17/32	7-15/32	4-5/16	2.38
802-040C	4	2-11/32	2-21/32	4-5/8	4-5/32	9-7/32	5-9/32	3.44
802-060CF	6	4	8-9/16	7-1/16	10	14-1/8	7-9/16	15.09
802-080CF	8	4-13/16	10-13/16	8-13/16	12-9/16	17-11/16	9-11/16	27.08

REDUCING TEE

Socket x Socket x Fipt

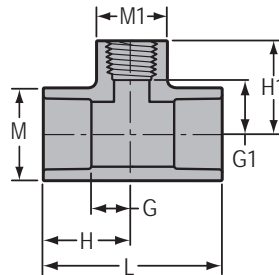

Part Number	Size	G	G1	H	H1	L	M	M1	Approx. Wt. (Lbs.)
802-101C	3/4x3/4x1/2	19/32	25/32	1-19/32	1-7/16	3-7/32	1-13/32	1-3/16	.15
802-130C	1x1x1/2	7/16	29/32	1-9/16	1-5/8	3-1/8	1-23/32	1-7/16	.19
802-131C	1x1x3/4	21/32	13/16	1-13/16	1-17/32	3-5/8	1-23/32	1-3/8	.22
802-166C	1-1/4x1-1/4x1/2	7/16	1-1/8	1-11/16	1-27/32	3-3/8	2-3/32	1-3/16	.26
802-167C ¹	1-1/4x1-1/4x3/4	7/8	1-23/32	2-1/8	2-7/16	4-7/32	2-3/32	1-3/4	.42
802-168C	1-1/4x1-1/4x1	27/32	1-1/32	2-3/32	1-29/32	4-7/32	2-3/32	1-11/16	.35
802-209C ¹	1-1/2x1-1/2x1/2	11/16	1-9/16	2-3/32	2-9/32	4-5/32	2-11/32	1-13/32	.42
802-210C ¹	1-1/2x1-1/2x3/4	7/8	1-27/32	2-1/4	2-19/32	4-1/2	2-3/8	1-11/16	.54

¹ Outlet sized with bushing

Schedule 80 CPVC Technical Information
Schedule 80 CPVC Fittings



REDUCING TEE (continued)

Socket x Socket x Fipt

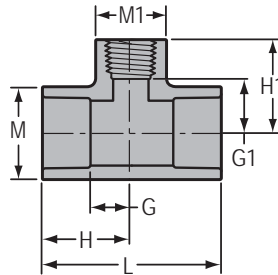

Part Number	Size	G	G1	H	H1	L	M	M1	Approx. Wt. (Lbs.)
802-211C	1-1/2x1-1/2x1	27/32	1-9/32	2-1/4	2-3/32	4-15/32	2-3/8	1-11/16	.43
802-212C	1-1/2x1-1/2x1-1/4	1-1/32	1-5/32	2-7/16	2-3/32	4-27/32	2-3/8	2-1/16	.49
802-247C ¹	2x2x1/2	1/2	1-1/2	2	2-7/32	4	2-7/8	1-3/16	.46
802-248C	2x2x3/4	5/8	1-3/8	2-1/8	2-3/32	4-1/4	2-7/8	1-3/8	.49
802-249C	2x2x1	27/32	1-1/2	2-11/32	2-11/32	4-11/16	2-7/8	1-11/16	.57
802-250C ¹	2x2x1-1/4	1-3/16	2-1/16	2-11/16	3	5-3/8	2-7/8	2-13/32	.90
802-251C ¹	2x2x1-1/2	1-7/16	2-5/16	2-15/16	3-11/32	5-7/8	2-7/8	2-7/8	1.21
802-287C	2-1/2x2-1/2x1/2	9/16	1-25/32	2-5/16	2-15/32	4-19/32	3-1/2	1-3/16	.81
802-288C ¹	2-1/2x2-1/2x3/4	27/32	2-11/32	2-21/32	3-5/32	5-9/32	3-9/16	1-13/16	1.12
802-289C ¹	2-1/2x2-1/2x1	1-3/32	2-11/32	2-27/32	3-1/4	5-11/16	3-1/2	2-1/8	1.21
802-290C ¹	2-1/2x2-1/2x1-1/4	1-3/16	2-15/32	2-31/32	3-15/32	5-15/16	3-1/2	2-3/8	1.34
802-291C ¹	2-1/2x2-1/2x1-1/2	1-7/16	2-1/2	3-3/16	3-1/2	6-3/8	3-1/2	2-7/8	1.55
802-292C ¹	2-1/2x2-1/2x2	1-3/4	3-15/16	3-1/2	2-7/8	7	3-15/32	3-15/32	2.15
802-333C ¹	3x3x1/2	7/8	2-11/16	2-3/4	3-7/16	5-1/2	4-1/8	1-23/32	1.30
802-334C ¹	3x3x3/4	7/8	2-19/32	2-3/4	3-11/32	5-1/2	4-3/16	1-3/4	1.33
802-335C ¹	3x3x1	1-3/16	2-31/32	3-1/16	3-7/8	6-1/8	4-1/8	2-11/32	1.61
802-337C ¹	3x3x1-1/2	1-7/16	2-23/32	3-5/16	3-23/32	6-5/8	4-1/4	2-29/32	1.98
802-338C ¹	3x3x2	2-3/32	3-11/32	3-31/32	4-3/8	7-15/16	4-5/32	4-5/32	3.51
802-339C ¹	3x3x2-1/2	2-3/32	2-3/4	3-31/32	4-5/16	7-15/16	4-1/8	4-1/8	3.34
802-415C ¹	4x4x1/2	1-7/16	3-5/8	3-11/16	4-3/8	7-3/8	5-1/4	2-7/8	2.71
802-416C ¹	4x4x3/4	1-15/32	3-27/32	3-23/32	4-17/32	7-7/16	5-1/4	2-7/8	2.86
802-417C ¹	4x4x1	1-7/16	3-17/32	3-23/32	4-13/32	7-13/32	5-1/4	2-7/8	2.87
802-419C ¹	4x4x1-1/2	3-11/16	3-1/2	3-11/16	3-31/32	7-3/8	5-1/4	2-7/8	2.80
802-420C ¹	4x4x2	2-1/8	4-1/32	4-3/8	5-1/32	8-25/32	5-1/4	4-3/16	3.84
802-421C ¹	4x4x2-1/2	2-1/8	3-15/32	4-3/8	5	8-25/32	5-1/4	4-3/16	3.71
802-422C ¹	4x4x3	2-5/8	3-5/8	4-7/8	5-1/4	9-3/4	5-1/4	5-1/4	5.30
802-525C ¹	6x6x1	2-1/16	5-3/16	5-3/32	6-1/16	10-5/32	7-19/32	4-1/4	9.23
802-529C ¹	6x6x2-1/2	2-1/16	4-21/32	5-3/32	6-3/16	10-5/32	7-19/32	4-1/4	9.12
802-530C ¹	6x6x3	2-11/16	4-3/4	5-9/16	6-3/8	11-1/8	7-1/2	5-1/4	8.33

¹ Outlet sized with bushing





Schedule 80 CPVC Technical Information
Schedule 80 CPVC Fittings

REDUCING TEE

Socket x Fipt x Socket

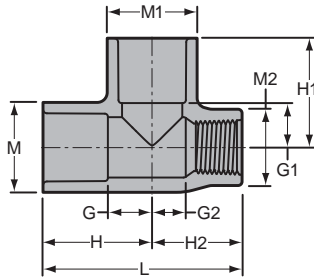

Part Number	Size	G	G1	G2	H	H1	H2	L	M	M1	M2	Approx. Wt. (Lbs.)
803-095C	3/4x1/2x3/4	11/16	11/16	11/16	1-11/16	1-11/16	1-3/8	3-3/32	1-13/32	1-13/32	1-3/16	.15

SPECIAL REINFORCED REDUCING TEE

Socket x SR Fipt x Socket

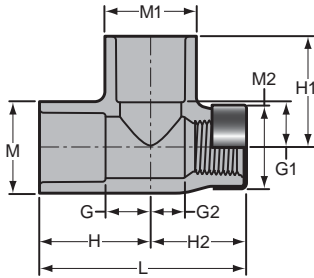

Part Number	Size	G	G1	G2	H	H1	H2	L	M	M1	M2	Approx. Wt. (Lbs.)
803-095CSR	3/4x1/2x3/4	11/16	11/16	11/16	1-11/16	1-11/16	1-13/32	3-1/8	1-13/32	1-13/32	1-7/32	.16

TEE

Socket x Socket x Brass Fipt

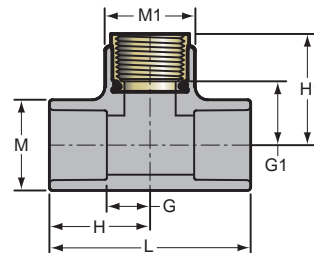

Part Number	Size	G	G1	H	H1	L	M	M1	Approx. Wt. (Lbs.)
802-005CBR	1/2	7/8	31/32	1-7/16	1-17/32	2-5/8	1-5/32	1-7/32	.16
802-007CBR	3/4	17/32	1-3/32	1-13/32	1-13/16	3-1/32	1-13/32	1-3/8	.38

Not intended to convey or dispense water for human consumption through drinking or cooking

Schedule 80 CPVC Technical Information
Schedule 80 CPVC Fittings



REDUCING TEE

Socket x Socket x Brass Fipt

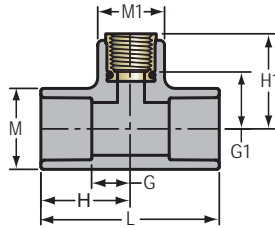

Part Number	Size	G	G1	H	H1	L	M	M1	Approx. Wt. (Lbs.)
802-101CBR	3/4x3/4x1/2	7/16	1-1/32	1-7/16	1-5/8	2-29/32	1-13/32	1-3/16	.20

Not intended to convey or dispense water for human consumption through drinking or cooking

SPECIAL REINFORCED TEE

Socket x Socket x SR Fipt

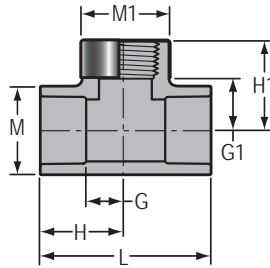

Part Number	Size	G	G1	H	H1	L	M	M1	Approx. Wt. (Lbs.)
802-005CSR	1/2	5/8	5/8	1-15/32	1-3/8	2-15/16	1-7/32	1-13/32	.15
802-007CSR	3/4	19/32	11/16	1-19/32	1-13/32	3-3/16	1-13/32	1-13/32	.15
802-010CSR	1	21/32	11/16	1-13/16	1-5/8	3-5/8	1-23/32	1-11/16	.28
802-012CSR	1-1/4	13/16	1-1/16	2-3/32	1-15/16	4-3/16	2-3/32	2-1/16	.38
802-015CSR	1-1/2	15/16	1-7/32	2-11/32	2-5/32	4-11/16	2-11/32	2-7/16	.53
802-020CSR	2	1-5/16	1-1/2	2-13/16	2-13/32	5-21/32	2-7/8	3-1/32	.83
802-030CSR	3	1-27/32	2-3/32	3-23/32	3-17/32	7-7/16	4-9/32	4-9/32	2.44
802-040CSR	4	2-11/32	2-21/32	4-5/8	4-5/32	9-7/32	5-1/4	5-1/4	3.52





Schedule 80 CPVC Technical Information
Schedule 80 CPVC Fittings

SPECIAL REINFORCED REDUCING TEE

Socket x Socket x SR Fipt

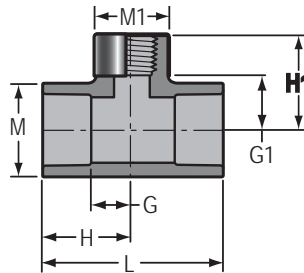

Part Number	Size	G	G1	H	H1	L	M	M1	Approx. Wt. (Lbs.)
802-072CSR	1/2x1/2x1/4	7/16	11/16	1-5/16	1-7/32	2-5/8	1-5/32	27/32	.09
802-098CSR	3/4x3/4x1/4	7/16	13/16	1-7/16	1-5/16	2-7/8	1-3/8	27/32	.12
802-101CSR	3/4x3/4x1/2	19/32	25/32	1-19/32	1-7/16	3-7/32	1-13/32	1-3/16	.15
802-128CSR ¹	1x1x1/4	7/8	2-5/8	2	2-11/16	4	2-3/32	27/32	.38
802-130CSR	1x1x1/2	7/16	29/32	1-9/16	1-5/8	3-1/8	1-23/32	1-3/16	.20
802-131CSR	1x1x3/4	21/32	7/8	1-13/16	1-19/32	3-19/32	1-23/32	1-3/8	.23
802-164CSR ¹	1-1/4x1-1/4x1/4	27/32	2-13/16	2-1/8	3-13/32	4-7/32	2-3/32	27/32	.45
802-166CSR	1-1/4x1-1/4x1/2	7/16	1-1/8	1-11/16	1-27/32	3-13/32	2-3/32	1-3/16	.27
802-168CSR	1-1/4x1-1/4x1/2	27/32	1-1/32	2-3/32	1-29/32	4-7/32	2-3/32	1-11/16	.36
802-207CSR ¹	1-1/2x1-1/2x1/4	27/32	1-31/32	2-1/4	2-19/32	4-15/32	2-11/32	1-3/4	.57
802-211CSR	1-1/2x1-1/2x1	27/32	1-7/32	2-1/4	2-1/8	4-15/32	2-3/8	1-11/16	.44
802-212CSR	1-1/2x1-1/2x1-1/4	1-1/32	1-5/32	2-7/16	2-3/32	4-27/32	2-3/8	2-1/16	.51
802-247CSR	2x2x1/2	1/2	1-1/2	2	2-1/4	4	2-7/8	1-3/16	.48
802-248CSR	2x2x3/4	19/32	1-13/32	2-1/8	2-1/8	4-1/4	2-7/8	1-3/8	.50
802-287CSR	2-1/2x2-1/2x1/2	9/16	1-3/4	2-5/16	2-1/2	4-19/32	3-1/2	1-7/32	.79
802-331CSR ¹	3x3x1/4	1-13/32	4-1/2	3-5/16	5-1/32	6-9/16	4-3/16	27/32	3.62
802-413CSR ¹	4x4x1/4	1-7/16	5-3/16	3-11/16	5-25/32	7-3/8	5-1/4	27/32	2.75

¹Outlet sized with bushing

TEE

Fipt x Fipt x Fipt

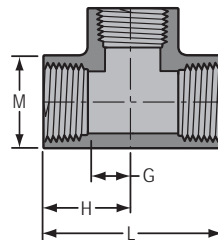

Part Number	Size	G	H	L	M	Approx. Wt. (Lbs.)
805-002C	1/4	1/2	1-3/32	2-3/16	27/32	.06
805-003C	3/8	9/16	1-5/32	2-5/16	15/16	.07
805-005C	1/2	17/32	1-1/4	2-15/32	1-3/16	.12
805-007C	3/4	21/32	1-15/32	2-15/16	1-1/2	.20
805-010C	1	23/32	1-3/4	3-1/2	1-11/16	.29
805-012C	1-1/4	15/16	1-31/32	3-29/32	2-1/4	.50
805-015C	1-1/2	1-1/8	2-3/16	4-3/8	2-13/32	.62
805-020C	2	1-5/8	2-5/8	5-1/4	3	1.15
805-025C	2-1/2	1-9/16	3-1/8	6-1/4	3-19/32	1.76
805-030C	3	1-15/16	3-9/16	7-3/32	4-11/32	3.01
805-040C	4	2-1/2	4-7/32	8-7/16	5-7/16	4.53
805-060CF	6	8-1/4	9-3/4	19-1/2	7-3/16	24.79

Schedule 80 CPVC Technical Information
Schedule 80 CPVC Fittings



SPECIAL REINFORCED TEE

SR Fipt x SR Fipt x SR Fipt

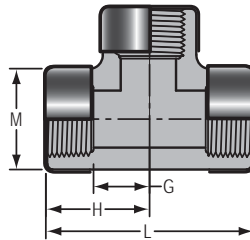

Part Number	Size	G	H	L	M	Approx. Wt. (Lbs.)
805-002CSR	1/4	1/2	1-3/32	2-3/16	27/32	.07
805-003CSR	3/8	19/32	1-3/16	2-11/32	31/32	.09
805-005CSR	1/2	1/2	1-1/4	2-1/2	1-3/16	.14
805-007CSR	3/4	19/32	1-11/32	2-11/16	1-3/8	.17
805-010CSR	1	7/8	1-25/32	3-9/16	1-11/16	.33
805-015CSR	1-1/2	1-1/4	2-3/16	4-13/32	2-13/32	.70
805-020CSR	2	1-5/8	2-5/8	5-1/4	3	1.27



STREET TEE

Spigot x Socket x Socket

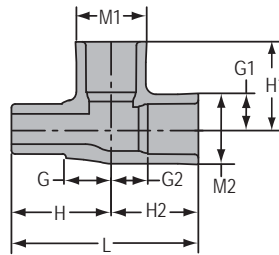

Part Number	Size	G	G1	G2	H	H1	H2	L	M1	M2	Approx. Wt. (Lbs.)
844-005C	1/2	23/32	23/32	1/2	1-19/32	1-21/32	1-19/32	3-5/32	1-3/16	1-3/16	.11
844-007C	3/4	13/16	27/32	7/8	1-13/16	1-7/8	1-13/16	3-5/8	1-13/32	1-13/32	.16
844-010C	1	1-3/32	13/16	13/16	2-7/32	2	2	4-7/32	1-3/4	1-3/4	.27
844-012C	1-1/4	1-1/4	1-5/32	1-1/8	2-7/16	2-5/16	2-7/16	4-7/8	2-3/32	2-3/32	.41
844-015C	1-1/2	1-13/16	1-1/8	1-1/8	2-7/8	2-9/16	2-9/16	5-11/32	2-11/32	2-11/32	.54
844-020C	2	1-23/32	1-7/16	1-13/32	3-1/4	2-15/16	2-15/16	6-5/32	2-7/8	2-7/8	.84



Schedule 80 CPVC Technical Information
Schedule 80 CPVC Fittings

90° ELBOW

Socket x Socket

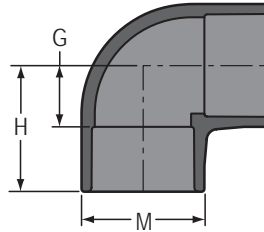

Part Number	Size	G	H	M	Approx. Wt. (Lbs.)
806-002C	1/4	11/32	1	13/16	.03
806-003C	3/8	15/32	1-1/4	31/32	.05
806-005C	1/2	9/16	1-15/32	1-3/16	.09
806-007C	3/4	5/8	1-11/16	1-7/16	.12
806-010C	1	7/8	2	1-3/4	.21
806-012C	1-1/4	1-1/32	2-9/32	2-3/32	.31
806-015C	1-1/2	1-5/32	1-9/16	2-3/8	.39
806-020C	2	1-13/32	2-15/16	2-7/8	.62
806-025C	2-1/2	1-9/16	3-11/32	3-15/32	1.15
806-030C	3	2-1/16	3-31/32	4-3/16	1.70
806-040C	4	2-5/8	4-7/8	5-7/32	2.93
806-050C	5	3	5-3/4	6-3/8	4.69
806-050CF	5	6-9/16	9-9/16	6-5/16	7.40
806-060C	6	3-3/4	6-3/4	7-19/32	7.43
806-080C	8	4-25/32	8-25/32	9-3/4	15.83
806-080CF	8	9-1/4	13-1/2	9-5/8	22.53
806-100C	10	5-25/32	10-13/16	12-5/32	27.41
806-100CF	10	11-13/16	17-1/16	11-15/16	40.28
806-120C	12	6-7/8	13-7/16	14-5/16	47.93
806-120CF	12	13-5/8	19-7/8	14-1/8	63.96
806-140C	14	7-1/2	14-1/2	15-11/16	55.89
806-140CF	14	16	23	15-1/2	86.72
806-160CF	16	18-7/16	26-7/16	17-11/16	133.22
806-180CF	18	20-7/8	29-7/8	19-7/8	175.62
806-200CF	20	23-5/16	33-5/16	22-1/16	250.00
806-240CF	24	28-1/4	40-1/4	26-7/16	---

Schedule 80 CPVC Technical Information
Schedule 80 CPVC Fittings



90° SWEEP ELBOW

Socket x Socket

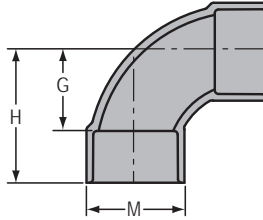

Part Number	Size	G	H	M	Approx. Wt. (Lbs.)
806-005SC	1/2	27/32	1-23/32	1-3/16	.08
806-007SC	3/4	1-1/32	2-1/32	1-13/32	.12
806-010SC	1	1-5/16	2-7/16	1-23/32	.20
806-012SC	1-1/4	1-9/16	2-13/16	2-3/32	.31
806-015SC	1-1/2	1-3/4	3-1/8	2-11/32	.40
806-020SC	2	2-5/16	3-13/16	2-7/8	.68

90° LONG SWEEP ELBOW

Socket x Socket

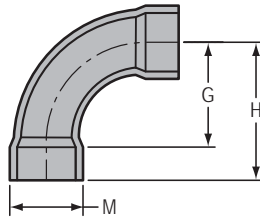

Part Number	Size	G	H	M	Approx. Wt. (Lbs.)
806-005LSCF	1/2	1-7/8	2-3/4	1-1/8	.13
806-007LSCF	3/4	2-7/16	3-7/16	1-7/16	.24
806-010LSCF	1	2-7/8	4	1-11/16	.37
806-012LSCF	1-1/4	3-5/8	4-7/8	2-1/16	.56
806-015LSCF	1-1/2	4-1/8	5-1/2	2-5/16	.68
806-020LSCF	2	4-3/4	6-5/16	2-13/16	1.07
806-025LSCF	2-1/2	5-3/4	7-3/4	3-7/16	1.70
806-030LSCF	3	7	9	4-1/8	2.69
806-040LSCF	4	9	11-1/4	5-3/16	4.85
806-060LSCF	6	13	16-1/4	7-1/2	12.84
806-080LSCF	8	23-1/2	27-3/4	9-5/8	33.18



Schedule 80 CPVC Technical Information
Schedule 80 CPVC Fittings

90° ELBOW

Socket x Fipt

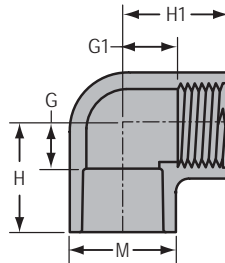

Part Number	Size	G	G1	H	H1	M	Approx. Wt. (Lbs.)
807-002C	1/4	5/16	5/16	15/16	15/16	7/8	.03
807-003C	3/8	1/4	3/8	1-1/32	1-1/32	1-1/32	.05
807-005C	1/2	15/32	9/16	1-11/32	1-9/32	1-3/16	.11
807-007C	3/4	5/8	5/8	1-9/16	1-9/16	1-3/8	.11
807-010C	1	11/16	25/32	1-13/16	1-11/16	1-23/32	.19
807-012C	1-1/4	23/32	1-1/32	1-31/32	1-31/32	2-1/16	.30
807-015C	1-1/2	15/16	1-7/32	2-11/32	2-5/32	2-11/32	.46
807-020C	2	15/16	1-1/32	2-7/16	2	3	.84
807-030C	3	1-27/32	2-7/32	3-23/32	3-9/16	4-9/32	2.02
807-040C	4	2-5/16	2-7/8	4-9/16	4-9/32	5-1/4	2.95

¹ Outlet sized with Female Adapter

90°REDUCING ELBOW

Socket x Fipt

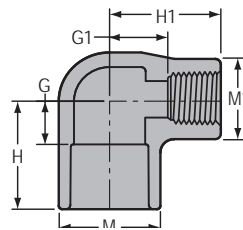

Part Number	Size	G	G1	H	H1	M	M1	Approx. Wt. (Lbs.)
807-101C	3/4x1/2	1/2	25/32	1-17/32	1-17/32	1-13/32	1-3/16	.12
807-130C ¹	1x1/2	27/32	1-17/32	1-31/32	2-1/4	1-23/32	1-23/32	.27
807-131C ¹	1x3/4	7/8	1-17/32	2	2-1/4	1-3/4	1-3/4	.26

¹ Outlet sized with Female Adapter

Schedule 80 CPVC Technical Information
Schedule 80 CPVC Fittings



SPECIAL REINFORCED 90° ELBOW

Socket x SR Fipt

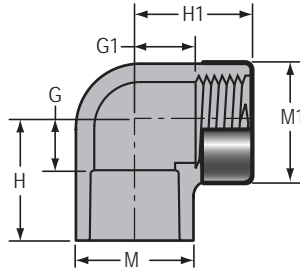

Part Number	Size	G	G1	H	H1	M	M1	Approx. Wt. (Lbs.)
807-005CSR	1/2	15/32	23/32	1-11/32	1-9/32	1-3/16	1-7/32	.09
807-007CSR	3/4	9/16	21/32	1-9/16	1-13/32	1-3/8	1-3/8	.12
807-010CSR	1	19/32	13/16	1-23/32	1-23/32	1-11/16	1-23/32	.21
807-012CSR	1-1/4	23/32	1-1/32	1-31/32	1-31/32	2-1/16	2-1/16	.31
807-015CSR	1-1/2	31/32	1-5/32	2-3/8	2-1/8	2-11/32	2-7/16	.44
807-020CSR	2	1-7/32	1-1/2	2-15/32	2-7/16	2-31/32	2-31/32	.91
807-030CSR	3	1-13/16	2-7/32	3-23/32	3-9/16	4-9/32	4-9/32	2.08
807-040CSR	4	2-9/32	2-25/32	4-9/16	4-7/32	5-1/4	5-1/4	3.02

SPECIAL REINFORCED REDUCING 90° ELBOW

Socket x SR Fipt

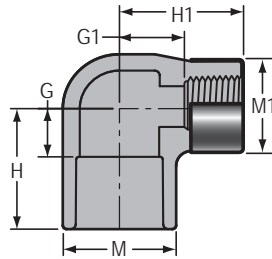

Part Number	Size	G	G1	H	H1	M	M1	Approx. Wt. (Lbs.)
807-101CSR	3/4x1/2	1/2	13/16	1-17/32	1-17/32	1-13/32	1-3/16	.12
807-130CSR	1x1/2	9/16	1	1-23/32	1-5/8	1-23/32	1-3/16	.14

TRANSITION 90° ELBOW

Socket x Brass Fipt

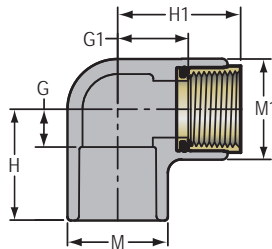

Part Number	Size	G	G1	H	H1	M	M1	Approx. Wt. (Lbs.)
807-005CBR	1/2	13/32	31/32	1-9/32	1-17/32	1-5/32	1-3/16	.15
807-007CBR	3/4	1/2	1-5/32	1-1/2	1-25/32	1-3/8	1-13/32	.21

Not intended to convey or dispense water for human consumption through drinking or cooking



Schedule 80 CPVC Technical Information
Schedule 80 CPVC Fittings

TRANSITION REDUCING

90° ELBOW

Socket x Brass Fipt

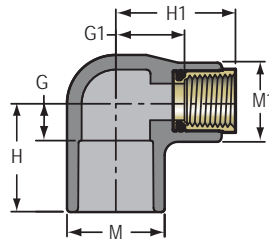

Part Number	Size	G	G1	H	H1	M	M1	Approx. Wt. (Lbs.)
807-101CBR	3/4x1/2	15/32	1-3/32	1-15/32	1-21/32	1-13/32	1-3/16	.21

Not intended to convey or dispense water for human consumption through drinking or cooking

90° ELBOW

Fipt x Fipt

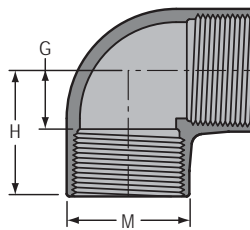

Part Number	Size	G	H	M	Approx. Wt. (Lbs.)
808-002C	1/4	11/32	15/16	7/8	.04
808-003C	3/8	9/16	1-5/32	15/16	.06
808-005C	1/2	1/2	1-7/32	1-9/32	.08
808-007C	3/4	5/8	1-3/8	1-3/8	.12
808-010C	1	25/32	1-5/8	1-23/32	.21
808-012C	1-1/4	15/16	1-7/8	2-1/16	.32
808-015C	1-1/2	1-5/32	2-3/32	2-7/16	.48
808-020C	2	1-9/16	2-17/32	3	.90
808-025C	2-1/2	1-5/8	3-3/16	3-9/16	1.26
808-030C	3	1-29/32	3-17/32	4-13/32	2.37
808-040C	4	2-15/32	4-3/16	5-15/32	3.44

SPECIAL REINFORCED

90° ELBOW

SR Fipt x SR Fipt

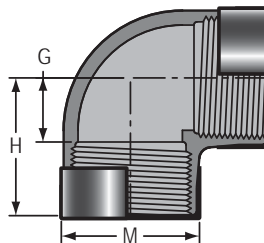

Part Number	Size	G	H	M	Approx. Wt. (Lbs.)
808-003CSR	3/8	9/16	1-5/32	15/16	.07
808-005CSR	1/2	1/2	1-7/32	1-3/16	.11
808-007CSR	3/4	5/8	1-3/8	1-3/8	.14
808-010CSR	1	25/32	1-11/16	1-23/32	.24
808-012CSR	1-1/4	15/16	1-7/8	2-1/16	.36
808-015CSR	1-1/2	1-1/32	2-1/8	2-7/16	.52
808-020CSR	2	1-19/32	2-1/2	3	1.04

Schedule 80 CPVC Technical Information
Schedule 80 CPVC Fittings



90° STREET ELBOW

Spigot x Socket

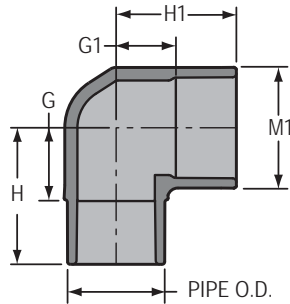

Part Number	Size	G	G1	H	H1	M1	Approx. Wt. (Lbs.)
809-005C	1/2	13/16	7/16	1-21/32	1-7/16	1-5/32	.08
809-007C	3/4	29/32	11/16	1-27/32	1-11/16	1-3/8	.12
809-010C	1	1-1/16	3/4	2-7/32	2	1-23/32	.20
809-012C	1-1/4	1-9/32	13/16	2-19/32	2-1/4	2-3/32	.31
809-015C	1-1/2	1-7/16	1-3/16	2-13/16	2-9/16	2-3/8	.43
809-020C	2	1-3/4	1-7/16	3-1/4	2-31/32	2-7/8	.64
809-025C	2-1/2	2-1/2	1-5/8	4-1/2	3-3/8	3-7/16	1.54
809-030C	3	2-3/8	1-13/16	4-1/4	3-11/16	4-3/16	1.70
809-040C	4	3-1/32	2-1/4	5-9/32	4-17/32	5-1/4	2.92
809-060C	6	5-1/4	3-11/16	8-7/16	6-3/4	7-9/16	10.01
809-080C	8	7-1/8	4-25/32	11-1/8	8-25/32	9-3/4	18.18
809-100C	10	8-5/8	5-13/16	14-5/16	11-3/8	12-1/16	41.05
809-120C	12	10-1/8	6-7/8	16-7/8	13-3/8	14-1/8	67.93
809-140C	14	11-1/16	7-9/16	18-5/16	14-5/8	15-11/16	77.21
809-140CF	14	19-1/2	16	27-1/2	23	15-1/2	101.86
809-160CF	16	22-7/16	18-7/16	31-7/16	26-7/16	17-11/16	135.72
809-180CF	18	25-3/8	20-7/8	35-3/8	29-7/8	19-7/8	217.54
809-200CF	20	28-5/16	23-5/16	39-5/16	33-5/16	22-1/16	266.40
809-240CF	24	34-1/4	28-1/4	47-1/4	40-1/4	26-7/16	435.00

90° STREET ELBOW

Mipt x Fipt

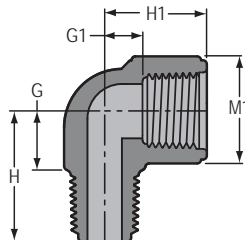

Part Number	Size	G	G1	H	H1	M1	Approx. Wt. (Lbs.)
812-002C	1/4	17/32	5/16	1-1/32	29/32	13/16	.03
812-005C	1/2	11/16	13/32	1-11/32	1-5/32	1-3/16	.06
812-007C	3/4	7/8	17/32	1-1/2	1-9/32	1-7/16	.09



Schedule 80 CPVC Technical Information
Schedule 80 CPVC Fittings

11-1/4° ELBOW

Socket x Socket

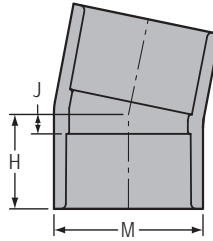

Part Number	Size	H	J	M	Approx. Wt. (Lbs.)
811-015C	1-1/2	1-19/32	7/32	2-3/8	.25
811-020C	2	1-23/32	7/32	2-27/32	.35
811-025CF	2-1/2	2-11/16	11/16	3-7/16	.88
811-030C	3	2-3/16	5/16	4-1/8	.92
811-040C	4	2-21/32	13/32	5-1/4	1.58
811-050CF	5	3-13/16	13/16	6-5/16	3.22
811-060CF	6	4-1/4	1	7-1/2	4.69
811-080CF	8	5-3/8	1-1/8	9-5/8	10.52
811-100CF	10	6-11/16	1-7/16	11-15/16	19.02
811-120CF	12	7-13/16	1-9/16	14-1/8	29.25
811-140CF	14	9	2	15-1/2	41.37
811-160CF	16	10-3/8	2-3/8	17-11/16	---
811-180CF	18	11-3/4	2-3/4	19-7/8	83.44
811-200CF	20	13-1/8	3-1/8	22-1/16	99.90
811-240CF	24	15-13/16	3-13/16	26-7/16	196.96

30° ELBOW

Socket x Socket

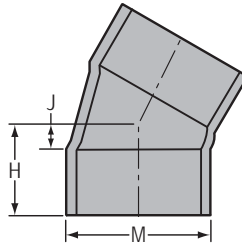

Part Number	Size	H	J	M	Approx. Wt. (Lbs.)
815-005CF	1/2	1-7/16	7/16	1-1/8	.07
815-007CF	3/4	1-7/16	7/16	1-3/8	.11
815-010CF	1	1-3/4	1/2	1-11/16	.16
815-012CF	1-1/4	2-3/16	11/16	2-1/16	.24
815-015CF	1-1/2	2-3/16	11/16	2-5/16	.32
815-020CF	2	2-1/2	3/4	2-13/16	.54
815-025CF	2-1/2	2-1/2	3/4	3-7/16	.93
815-030CF	3	3-5/16	1-1/16	4-1/8	1.44
815-040CF	4	3-7/16	1-3/16	5-3/16	2.27
815-050CF	5	4-3/8	1-3/8	6-5/16	3.22
815-060C	6	4-13/16	1-7/8	7-9/16	5.89

Schedule 80 CPVC Technical Information
Schedule 80 CPVC Fittings



30° ELBOW
 Socket x Socket (continued)

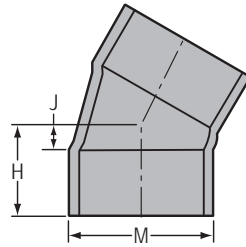

Part Number	Size	H	J	M	Approx. Wt. (Lbs.)
815-080CF	8	6-3/16	1-15/16	9-5/8	11.08
815-100CF	10	7-3/4	2-1/2	11-15/16	21.26
815-120CF	12	9-1/16	2-13/16	14-1/8	32.33
815-140CF	14	10-7/16	3-7/16	15-1/2	37.18
815-160CF	16	11-15/16	3-15/16	17-11/16	64.23
815-180CF	18	13-7/16	4-7/16	19-7/8	92.38
815-200CF	20	15	5	22-1/16	109.89
815-240CF	24	18-1/8	6-1/8	26-7/16	185.25

22-1/2° ELBOW
 Socket x Socket

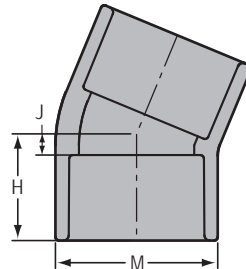

Part Number	Size	H	J	M	Approx. Wt. (Lbs.)
816-005C	1/2	1-1/16	3/16	1-5/32	.06
816-007C	3/4	1-3/16	3/16	1-7/16	.09
816-010C	1	1-3/8	9/32	1-23/32	.14
816-012C	1-1/4	1-1/2	5/16	2-3/32	.20
816-015C	1-1/2	1-21/32	1/4	2-3/8	.26
816-015CF	1-1/2	2-1/8	5/8	2-5/16	.28
816-020C	2	1-7/8	7/16	2-7/8	.44
816-025C	2-1/2	2-7/32	15/32	3-1/2	.72
816-025CF	2-1/2	2-7/8	7/8	3-7/16	.84
816-030C	3	2-13/32	9/16	4-5/32	1.01
816-040C	4	2-7/8	5/8	5-1/4	1.71
816-050CF	5	4-1/8	1-1/8	6-5/16	3.22



Schedule 80 CPVC Technical Information
Schedule 80 CPVC Fittings

22-1/2° ELBOW (continued)

Socket x Socket

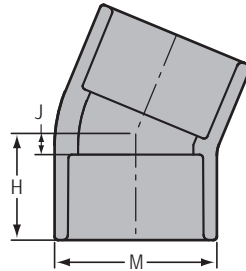

Part Number	Size	H	J	M	Approx. Wt. (Lbs.)
816-060C	6	4-9/16	1-3/8	7-7/16	4.59
816-060CF	6	4-5/8	1-3/8	7-1/2	5.29
816-080C	8	5-1/16	1-1/32	9-3/4	8.95
816-080CF	8	5-7/8	1-5/8	9-5/8	9.60
816-100CF	10	7-5/16	2-1/16	11-15/16	18.77
816-120CF	12	8-9/16	2-5/16	14-1/8	30.79
816-140CF	14	9-13/16	2-13/16	15-1/2	40.74
816-160CF	16	11-5/16	3-5/16	17-11/16	57.95
816-180CF	18	12-3/4	3-3/4	19-7/8	86.42
816-200CF	20	14-1/4	4-1/4	22-1/16	103.23
816-240CF	24	17-3/16	5-3/16	26-7/16	---

22-1/2° STREET ELBOW

Spigot x Socket

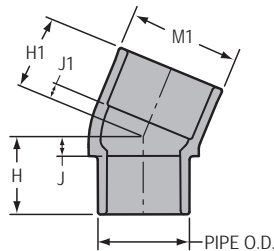

Part Number	Size	H	H1	J	J1	M1	Approx. Wt. (Lbs.)
842-005C	1/2	7/8	1	1/8	1/8	1-3/16	.05
842-007C	3/4	1-1/4	1-5/32	3/16	3/16	1-3/8	.09
842-010C	1	1-7/16	1-11/32	5/16	7/32	1-23/32	.14
842-012C	1-1/4	1-9/16	1-9/16	5/16	3/8	2-3/32	.22
842-015C	1-1/2	1-21/32	1-7/8	9/32	1/2	2-3/8	.29
842-020C	2	2	1-29/32	15/32	13/32	2-7/8	.43
842-025C	2-1/2	2-7/32	2-7/32	15/32	15/32	3-1/2	.76
842-030C	3	2-1/2	2-5/16	21/32	7/16	4-5/32	1.00
842-040C	4	2-27/32	3-1/32	9/16	25/32	5-1/4	2.59
842-060C	6	5-11/16	3-15/16	2-3/8	7/8	7-5/8	6.87
842-080C	8	7-3/8	5-1/8	3-1/8	1-1/8	9-3/4	12.71

Schedule 80 CPVC Technical Information
Schedule 80 CPVC Fittings



45° ELBOW

Socket x Socket

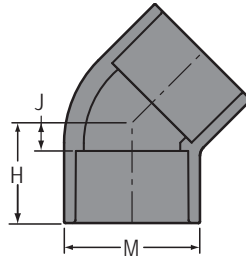

Part Number	Size	H	J	M	Approx. Wt. (Lbs.)
817-002C	1/4	13/16	5/32	27/32	.03
817-003C	3/8	31/32	7/32	1	.04
817-005C	1/2	1-1/8	1/4	1-3/16	.07
817-007C	3/4	1-5/16	5/16	1-7/16	.10
817-010C	1	1-7/16	5/16	1-23/32	.16
817-012C	1-1/4	1-5/8	3/8	2-1/8	.24
817-015C	1-1/2	1-13/16	7/16	2-3/8	.32
817-020C	2	2-1/8	5/8	2-7/8	.47
817-025C	2-1/2	2-13/32	21/32	3-1/2	.82
817-030C	3	2-29/32	29/32	4-5/32	1.16
817-040C	4	3-5/16	1-1/16	5-1/4	2.05
817-050C	5	4	1-11/32	6-13/32	3.31
817-050CF	5	4-7/8	1-7/8	6-5/16	4.25
817-060C	6	4-3/4	1-3/4	7-19/32	5.49
817-080C	8	6	2	9-3/4	10.43
817-100C	10	8-3/16	2-19/32	12-3/16	21.29
817-100CF	10	8-11/16	3-7/16	11-15/16	23.50
817-120C	12	9-11/16	3-3/32	14-13/32	35.49
817-120CF	12	10-1/8	3-7/8	14-1/8	32.40
817-140C	14	10-5/16	3-5/16	15-5/8	40.60
817-140CF	14	11-9/16	4-9/16	15-1/2	41.37
817-160CF	16	13-5/16	5-5/16	17-11/16	57.91
817-180CF	18	15	6	19-7/8	88.48
817-200CF	20	16-3/4	6-3/4	22-1/16	123.21
817-240CF	24	20-3/16	8-3/16	26-7/16	---





Schedule 80 CPVC Technical Information
Schedule 80 CPVC Fittings

15° ELBOW
 Socket x Socket

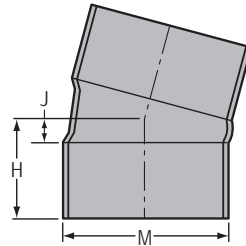

Part Number	Size	H	J	M	Approx. Wt. (Lbs.)
818-020CF	2	2-5/16	9/16	2-13/16	.54
818-025CF	2-1/2	2-3/4	3/4	3-7/16	.69
818-030CF	3	3	3/4	4-1/8	1.44
818-040CF	4	3-1/8	7/8	5-3/16	1.96
818-050CF	5	3-15/16	15/16	6-5/16	3.22
818-060CF	6	4-3/8	1-1/8	7-1/2	5.38
818-080CF	8	4-1/2	1-1/4	9-5/8	10.52
818-100CF	10	6-15/16	1-11/16	11-15/16	19.02
818-120CF	12	8-1/16	1-13/16	14-1/8	29.25
818-140CF	14	9-5/16	2-5/16	15-1/2	40.75
818-160CF	16	10-11/16	2-11/16	17-11/16	59.47
818-180CF	18	12-1/16	3-1/16	19-7/8	83.44
818-200CF	20	13-1/2	3-1/2	22-1/16	99.90
818-240CF	24	16-1/4	4-1/4	26-7/16	202.28



Schedule 80 CPVC Technical Information
Schedule 80 CPVC Fittings



45° ELBOW

Fipt x Fipt

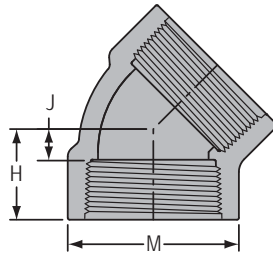

Part Number	Size	H	J	M	Approx. Wt. (Lbs.)
819-002C	1/4	25/32	3/16	27/32	.03
819-003C	3/8	13/16	3/16	1	.04
819-005C	1/2	31/32	5/16	1-3/16	.08
819-007C	3/4	1-3/32	13/32	1-3/8	.07
819-010C	1	1-7/32	7/32	1-11/16	.15
819-012C	1-1/4	1-7/16	7/16	2-3/16	.25
819-015C	1-1/2	1-1/2	15/32	2-1/2	.33
819-020C	2	1-23/32	21/32	3	.48
819-025C	2-1/2	2-17/32	31/32	3-1/2	1.24
819-030C	3	2-23/32	1	4-9/32	1.92
819-040C	4	3-1/4	1-7/32	5-1/4	2.79



SPECIAL REINFORCED 45° ELBOW

SR Fipt x SR Fipt

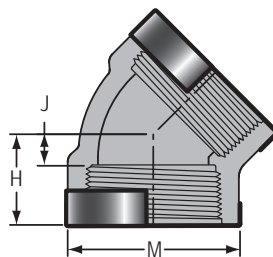

Part Number	Size	H	J	M	Approx. Wt. (Lbs.)
819-005CSR	1/2	1	5/16	1-3/16	.09
819-007CSR	3/4	1-1/8	13/32	1-3/8	.11
819-010CSR	1	1-1/4	13/32	1-23/32	.18



Schedule 80 CPVC Technical Information
Schedule 80 CPVC Fittings

60° ELBOW

Socket x Socket

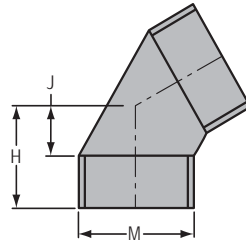

Part Number	Size	H	J	M	Approx. Wt. (Lbs.)
824-005CF	1/2	1-5/8	5/8	1-1/8	.14
824-007CF	3/4	1-11/16	11/16	1-3/8	.09
824-010CF	1	2	3/4	1-11/16	.34
824-012CF	1-1/4	2-1/2	1	2-1/16	.69
824-015CF	1-1/2	2-5/8	1-1/8	1-3/8	.37
824-020CF	2	3	1-1/4	2-13/16	.59
824-025CF	2-1/2	3-9/16	1-9/16	3-7/16	.95
824-030CF	3	4	1-3/4	4-1/8	1.34
824-040CF	4	4-5/16	2-1/16	5-3/16	5.10
824-050CF	5	5-3/8	2-3/8	6-5/16	7.39
824-060CF	6	6-1/8	2-7/8	7-1/2	10.87
824-080CF	8	7-3/4	3-1/2	9-5/8	19.49
824-100CF	10	9-11/16	4-7/16	11-15/16	36.34
824-120CF	12	11-5/16	5-1/16	14-1/8	63.05
824-140CF	14	12-15/16	5-15/16	15-1/2	88.90
824-160CF	16	14-13/16	6-13/16	17-11/16	126.09
824-180CF	18	16-3/4	7-3/4	19-7/8	175.82
824-200CF	20	26-5/8	16-5/8	22-1/16	247.63
824-240CF	24	32-1/8	20-1/8	26-7/16	362.00

45° STREET ELBOW

Spigot x Socket

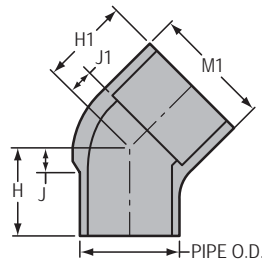

Part Number	Size	H	H1	J	J1	M1	Approx. Wt. (Lbs.)
827-005C	1/2	1-9/32	1-5/16	11/32	7/16	1-3/16	.06
827-007C	3/4	1-1/2	1-1/2	7/16	1/2	1-13/32	.10
827-010C	1	1-25/32	1-1/2	19/32	3/8	1-3/4	.16
827-012C	1-1/4	2	1-23/32	5/8	15/32	2-3/32	.24
827-015C	1-1/2	2-1/32	2-1/8	19/32	25/32	2-11/32	.32
827-020C	2	2-5/16	2-11/32	11/16	3/8	2-27/32	.47
827-025C	2-1/2	3-11/16	2-9/16	1-11/16	13/16	3-1/2	1.29
827-030C	3	3-1/4	2-13/16	1-3/16	29/32	4-5/32	1.25
827-040C	4	3-13/16	3-13/16	1-9/32	1-9/16	5-1/4	2.20
827-060C	6	5-3/32	4-25/32	2-1/16	2-1/16	7-19/32	5.91
827-080C	8	6-5/8	5-31/32	2-19/32	1-3/4	9-3/4	10.51

Schedule 80 CPVC Technical Information
Schedule 80 CPVC Fittings



45° STREET ELBOW (continued)

Spigot x Socket

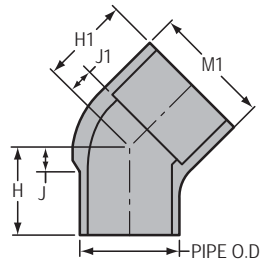

Part Number	Size	H	H1	J	J1	M1	Approx. Wt. (Lbs.)
827-100C	10	10-21/32	8-3/16	2-19/32	5-5/16	12-3/16	26.59
827-120C	12	13-1/4	9-11/16	6-3/8	3-3/32	14-13/32	46.00
827-140CF	14	11-9/16	11-9/16	4-9/16	4-9/16	15-1/2	70.37
827-160CF	16	18-5/16	13-5/16	9-5/16	5-5/16	17-11/16	90.40
827-180CF	18	20-1/2	15	10-1/2	6	19-7/8	131.12
827-200CF	20	22-3/4	16-3/4	11-3/4	6-3/4	22-1/16	153.18
827-240CF	24	27-3/16	20-3/16	14-3/16	8-3/16	26-7/16	---

CROSS

Socket x Socket x Socket x Socket

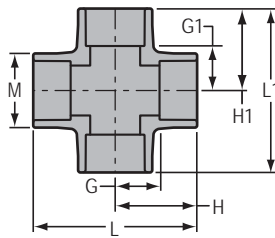

Part Number	Size	G	G1	H	H1	L	L1	M	Approx. Wt. (Lbs.)
820-002C	1/4	13/32	13/32	1-1/32	1-1/32	2-1/16	2-1/16	27/32	.05
820-005C	1/2	9/16	9/16	1-15/32	1-15/32	2-15/16	2-15/16	1-3/16	.13
820-007C	3/4	5/8	5/8	1-5/8	1-5/8	3-9/32	3-9/32	1-13/32	.21
820-010C	1	31/32	31/32	2-3/32	2-3/32	4-7/32	4-7/32	1-23/32	.46
820-012C	1-1/4	1-3/32	1-3/32	2-3/8	2-3/8	4-3/4	4-3/4	2-1/8	.65
820-015C	1-1/2	1-1/4	1-1/4	2-5/8	2-5/8	5-1/4	5-1/4	2-3/8	.81
820-020C	2	1-1/2	1-1/2	3	3	6	6	3	1.38
820-025C	2-1/2	1-11/16	1-11/16	3-15/32	3-15/32	6-29/32	6-29/32	3-17/32	2.11
820-030C	3	2-3/32	2-3/32	3-31/32	3-31/32	7-15/16	7-15/16	4-11/32	3.39
820-040C	4	2-5/8	2-5/8	4-7/8	4-7/8	9-3/4	9-3/4	5-11/32	5.30
820-050CF	5	5-1/2	5-1/2	8-1/2	8-1/2	17	17	6-5/16	15.06
820-060CF	6	6-1/4	6-1/4	9-1/2	9-1/2	19	19	7-1/2	16.94
820-080CF	8	7-5/8	7-5/8	11-7/8	11-7/8	23-3/4	23-3/4	9-5/8	40.50
820-100CF	10	9	9	14-1/4	14-1/4	28-1/2	28-1/2	11-15/16	67.20
820-120CF	12	11-1/4	11-1/4	17-1/2	17-1/2	35	35	14-1/8	107.80
820-140CF	14	12-1/4	12-1/4	19-1/4	19-1/4	38-1/2	38-1/2	15-1/2	148.16
820-160CF	16	13	13	21	21	42	42	17-11/16	180.80
820-180CF	18	13-3/4	13-3/4	22-3/4	22-3/4	45-1/2	45-1/2	19-7/8	198.00
820-200CF	20	16-3/8	16-3/8	26-3/8	26-3/8	52-3/4	52-3/4	22-1/16	249.75
820-240CF	24	20-1/4	20-1/4	32-1/4	32-1/4	64-1/2	64-1/2	26-7/16	355.98



Schedule 80 CPVC Technical Information
Schedule 80 CPVC Fittings

REDUCING CROSS

Socket x Socket x Socket x Socket

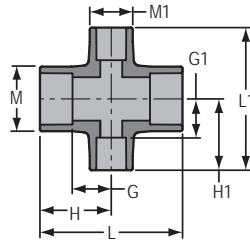

Part Number	Size	G	G1	H	H1	L	L1	M	M1	Approx. Wt. (Lbs.)
820-130C ¹	1x1x1/2x1/2	1	1-7/16	2-1/8	2-3/8	4-7/32	4-3/4	1-23/32	1-23/32	.59
820-131C	1x1x1/2x3/4	23/32	5/8	1-5/8	1-5/8	3-1/4	3-1/4	1-7/8	1-1/2	.31
820-166C ¹	1-1/4x1-1/4x1/2x1/2	1-3/32	1-3/32	2-3/8	2-11/16	4-3/4	5-3/16	3-3/32	3-3/32	.84
820-167C	1-1/4x1-1/4x3/4x3/4	1-1/16	23/32	2-1/16	1-31/32	4-3/32	3-31/32	2-1/16	1-13/32	.35
820-209C ¹	1-1/2x1-1/2x1/2x1/2	1-7/32	1-7/32	2-21/32	2-31/32	5-1/4	5-15/16	2-3/8	2-3/8	1.21
820-210C	1-1/2x1-1/2x3/4x3/4	11/16	1-5/32	2-3/32	2-3/16	4-3/16	4-11/32	2-3/8	1-13/32	.42
820-211C ¹	1-1/2x1-1/2x1x1	1-3/4	1-3/4	2-5/8	3	5-5/16	5-7/8	1-3/8	1-3/8	1.16
820-248C	2x2x3/4x3/4	11/16	1-7/16	2-7/32	2-7/16	4-13/32	4-7/8	2-29/32	1-13/32	.56
820-249C ¹	2x2x1x1	1-1/2	2-9/32	3	3-7/16	6	6-27/32	3	3	1.99
820-289C	2-1/2x2-1/2x1x1	7/8	1-23/32	2-11/16	2-7/8	5-11/32	5-3/4	3-1/2	1-3/4	1.00
820-291C ¹	2-1/2x2-1/2x1-1/2x1-1/2	1-11/16	2-15/32	3-7/16	3-27/32	6-7/8	7-23/32	3-9/16	3-9/16	2.97
820-336C ¹	3x3x1-1/4x1-1/4	2-3/32	3-1/8	3-31/32	4-3/8	7-29/32	8-3/4	4-3/16	4-3/16	4.46
820-338C ¹	3x3x2x2	2-3/32	2-27/32	3-31/32	4-5/16	7-29/32	8-5/8	4-13/32	4-5/16	4.46
820-420C ¹	4x4x2x2	2-5/8	3-13/16	4-7/8	5-11/32	9-3/4	10-21/32	5-11/32	5-7/32	7.83
820-420CF	4x4x2x2	3-7/8	4-1/4	6-1/8	6	12-1/4	12	5-3/16	2-13/16	5.79
820-422C ¹	4x4x3x3	2-5/8	3-7/16	4-7/8	5-5/16	9-3/4	10-5/8	5-1/4	5-1/4	7.21
820-528CF	6x6x2x2	4-5/8	5-3/16	7-7/8	6-15/16	15-3/4	13-7/8	7-1/2	2-13/16	8.70
820-530CF	6x6x3x3	4-3/4	5-3/4	8	8	16	16	7-1/2	4-1/8	10.24
820-532CF	6x6x4x4	5-1/4	6-3/4	8-1/2	9	17	18	7-1/2	5-3/16	15.93
820-533CF	6x6x5x5	5-3/4	6-1/2	9	9-1/2	18	19	7-1/2	6-5/16	14.41
820-578CF	8x8x2x2	4-11/16	6-1/8	8-15/16	7-7/8	17-7/8	15-3/4	9-5/8	2-13/16	15.90
820-580CF	8x8x3x3	5-3/16	6-11/16	9-7/16	8-15/16	18-7/8	17-7/8	9-5/8	4-1/8	13.77
820-582CF	8x8x4x4	5-3/4	7-11/16	10	9-15/16	20	19-7/8	9-5/8	5-3/16	24.71
820-585CF	8x8x6x6	6-3/4	8-1/16	11	11-5/16	22	22-5/8	9-5/8	7-1/2	30.75
820-621CF	10x10x2x2	4-3/8	7-1/8	9-5/8	8-7/8	19-1/4	17-11/16	11-15/16	2-13/16	27.78
820-623CF	10x10x3x3	4-7/8	7-11/16	10-1/8	9-15/16	20-1/4	19-13/16	11-15/16	4-1/8	30.16
820-624CF	10x10x4x4	5-3/8	8-11/16	10-5/8	10-15/16	21-1/4	21-13/16	11-15/16	5-3/16	28.17
820-626CF	10x10x6x6	5-7/8	9-1/16	11-1/8	12-5/16	22-1/4	24-5/8	11-15/16	7-1/2	38.61
820-628CF	10x10x8x8	8-1/4	9-15/16	13-1/2	14-3/16	27	28-3/8	11-15/16	9-5/8	59.10
820-661CF	12x12x2x2	4-3/4	8	11	9-3/4	22	19-1/2	14-1/8	2-13/16	44.02
820-663CF	12x12x3x3	5-1/4	8-9/16	11-1/2	10-13/16	23	21-5/8	14-1/8	4-1/8	45.28
820-664CF	12x12x4x4	5-3/4	9-9/16	12	11-13/16	24	23-5/8	14-1/8	5-3/16	42.60
820-666CF	12x12x6x6	7-1/4	9-15/16	13-1/4	13-3/16	26-1/2	26-3/8	14-1/8	7-1/2	61.56
820-668CF	12x12x8x8	8	10-13/16	14-1/4	15-1/16	28-1/2	30-1/8	14-1/8	9-5/8	73.35
820-670CF	12x12x10x10	10-1/4	10-13/16	16-1/2	16-1/16	33	32-1/8	14-1/8	11-15/16	78.03
820-691CF	14x14x2x2	5-3/16	8-9/16	12-3/16	10-5/16	24-3/8	20-5/8	15-1/2	2-13/16	45.02

¹ Outlet sized with bushing

Schedule 80 CPVC Technical Information
Schedule 80 CPVC Fittings



REDUCING CROSS (continued)

Socket x Socket x Socket x Socket

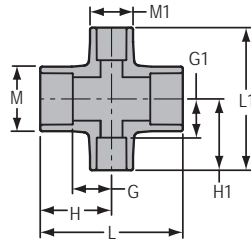

Part Number	Size	G	G1	H	H1	L	L1	M	M1	Approx. Wt. (Lbs.)
820-693CF	14x14x3x3	5-3/4	9-1/8	12-3/4	11-3/8	25-1/2	22-3/4	15-1/2	4-1/8	57.57
820-694CF	14x14x4x4	6-1/2	10-1/8	13-1/2	12-3/8	27	24-3/4	15-1/2	5-3/16	69.17
820-696CF	14x14x6x6	8-1/4	10-1/2	15-1/4	13-3/4	30-1/2	27-1/2	15-1/2	7-1/2	63.15
820-698CF	14x14x8x8	9-1/4	11-3/8	16-1/4	15-5/8	32-1/2	31-1/4	15-1/2	9-5/8	68.17
820-700CF	14x14x10x10	10-1/8	11-3/8	17-1/8	16-5/8	34-1/4	33-1/4	15-1/2	11-15/16	89.80
820-702CF	14x14x12x12	11	11-3/8	18	17-5/8	36	35-1/4	15-1/2	14-1/8	93.81
820-751CF	16x16x2x2	5-7/8	9-1/2	13-7/8	11-1/4	27-3/4	22-1/2	17-11/16	2-13/16	71.71
820-752CF	16x16x2-1/2x2-1/2	6	9-11/16	14	11-11/16	28	23-3/8	17-11/16	3-7/16	65.37
820-753CF	16x16x3x3	6-5/16	10-1/16	14-5/16	12-5/16	28-5/8	24-5/8	17-11/16	4-1/8	67.39
820-754CF	16x16x4x4	6-1/8	11-1/16	14-1/8	13-5/16	28-1/4	26-5/8	17-11/16	5-3/16	70.21
820-756CF	16x16x6x6	8-5/8	11-7/16	16-5/8	14-11/16	33-1/4	29-3/8	17-11/16	7-1/2	90.09
820-758CF	16x16x8x8	9-5/8	12-5/16	17-5/8	16-9/16	35-1/4	33-1/8	17-11/16	9-5/8	98.69
820-760CF	16x16x10x10	10-5/8	12-5/16	18-5/8	17-9/16	37-1/4	35-1/8	17-11/16	11-15/16	103.85
820-762CF	16x16x12x12	11-5/8	12-5/16	19-5/8	18-9/16	39-1/4	37-1/8	17-11/16	14-1/8	116.70
820-764CF	16x16x14x14	12-3/4	12-11/16	20-3/4	19-11/16	41-1/2	39-3/8	17-11/16	15-1/2	135.00
820-784CF	18x18x4x4	6-7/8	11-15/16	15-7/8	14-3/16	31-3/4	28-3/8	19-7/8	5-3/16	99.22
820-786CF	18x18x6x6	8-1/2	12-5/16	17-1/2	15-9/16	35	31-1/8	19-7/8	7-1/2	122.13
820-788CF	18x18x8x8	9-1/2	13-3/16	18-1/2	17-7/16	37	34-7/8	19-7/8	9-5/8	135.00
820-790CF	18x18x10x10	10-1/2	13-3/16	19-1/2	18-7/16	39	36-7/8	19-7/8	11-15/16	150.90
820-792CF	18x18x12x12	11-1/2	13-3/16	20-1/2	19-7/16	41	38-7/8	19-7/8	14-1/8	169.57
820-794CF	18x18x14x14	12-3/4	13-9/16	21-3/4	20-9/16	43-1/2	41-1/8	19-11/16	15-1/2	165.78
820-796CF	18x18x16x16	13-1/2	14-3/16	22-1/2	22-3/16	45	44-3/8	19-11/16	17-11/16	172.46
820-814CF	20x20x4x4	7-11/16	12-7/8	17-11/16	15-1/8	35-3/8	30-1/4	22-1/16	5-3/16	116.55
820-816CF	20x20x6x6	8-7/8	13-1/4	18-7/8	16-1/2	37-3/4	33	22-1/16	7-1/2	140.98
820-818CF	20x20x8x8	9-7/8	14-1/8	19-7/8	18-3/8	39-3/4	36-3/4	22-1/16	9-5/8	151.48
820-820CF	20x20x10x10	10-7/8	14-1/8	20-7/8	19-3/8	41-3/4	38-3/4	22-1/16	11-15/16	163.28
820-822CF	20x20x12x12	11-7/8	14-1/8	21-7/8	20-3/8	43-3/4	40-3/4	22-1/16	14-1/8	176.50
820-824CF	20x20x14x14	12-7/8	14-1/2	22-7/8	21-1/2	45-3/4	43	22-1/16	15-1/2	190.95
820-826CF	20x20x16x16	14	15-1/8	24	23-1/8	48	46-1/4	22-1/16	17-11/16	210.27
820-828CF	20x20x18x18	15	15	25	24	50	48	22-1/16	19-7/8	226.80
820-904CF	24x24x4x4	9	14-11/16	21	16-15/16	42	33-7/8	26-7/16	5-3/16	195.97
820-906CF	24x24x6x6	9-1/4	15-1/16	21-1/4	18-5/16	42-1/2	36-5/8	26-7/16	7-1/2	202.94
820-908CF	24x24x8x8	10-1/4	15-15/16	22-1/4	20-3/16	44-1/2	40-3/8	26-7/16	9-5/8	236.29
820-910CF	24x24x10x10	11-1/4	15-15/16	23-1/4	21-3/16	46-1/2	42-3/8	26-7/16	11-15/16	255.96





Schedule 80 CPVC Technical Information
Schedule 80 CPVC Fittings

REDUCING CROSS (continued)

Socket x Socket x Socket x Socket

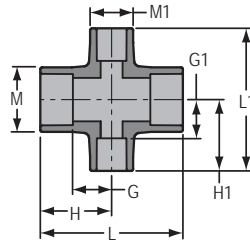

Part Number	Size	G	G1	H	H1	L	L1	M	M1	Approx. Wt. (Lbs.)
820-912CF	24x24x12x12	12-1/4	15-15/16	24-1/4	22-3/16	48-1/2	44-3/8	26-7/16	14-1/8	280.93
820-914CF	24x24x14x14	13-1/4	16-5/16	25-1/4	23-5/16	50-1/2	46-5/8	26-1/16	15-1/2	282.43
820-916CF	24x24x16x16	14-3/4	16-15/16	26-3/4	24-15/16	53-1/2	49-7/8	26-7/16	17-11/16	306.44
820-918CF	24x24x18x18	15-3/4	16-13/16	27-3/4	25-13/16	55-1/2	51-5/8	26-7/16	19-7/8	246.78
820-920CF	24x24x20x20	16-3/4	18-3/16	28-3/4	28-3/16	57-1/2	56-3/8	26-7/16	22-1/16	351.60

COUPLING

Socket x Socket

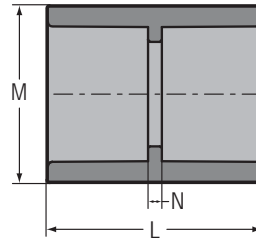

Part Number	Size	L	M	N	Approx. Wt. (Lbs.)
829-002C	1/4	1-3/8	27/32	1/16	.02
829-003C	3/8	1-5/8	1	3/32	.04
829-005C	1/2	1-7/8	1-3/16	1/8	.07
829-007C	3/4	2-1/8	1-13/32	1/8	.10
829-010C	1	2-15/32	1-23/32	3/16	.13
829-012C	1-1/4	2-23/32	2-7/32	7/32	.23
829-015C	1-1/2	2-7/8	2-11/32	3/32	.22
829-020C	2	3-1/8	2-27/32	3/32	.32
829-025C	2-1/2	3-11/16	3-15/32	1/4	.58
829-030C	3	3-31/32	4-5/32	3/16	.82
829-040C	4	4-3/4	5-5/16	1/4	1.36
829-050C	5	5-15/32	6-3/8	7/32	2.18
829-050CF	5	8	6-5/16	2	2.32
829-060C	6	6-3/8	7-9/16	1/4	3.93
829-080C	8	8-1/4	9-23/32	9/32	6.95
829-100C	10	10-9/32	12-1/16	1/4	12.31
829-100CF	10	12-1/2	11-15/16	2	16.78
829-120C	12	12-3/8	14-7/32	3/8	20.05

Schedule 80 CPVC Technical Information
Schedule 80 CPVC Fittings



COUPLING (continued)

Socket x Socket

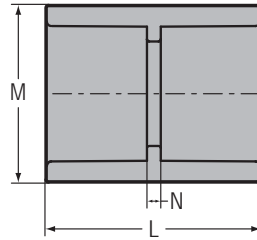

Part Number	Size	L	M	N	Approx. Wt. (Lbs.)
829-120CF	12	15-1/4	14-1/8	2-3/4	27.71
829-140C	14	14-7/16	15-5/8	3/8	28.11
829-140CF	14	16	15-1/2	2	33.33
829-160CF	16	18-5/8	17-11/16	2-5/8	42.93
829-180CF	18	22	19-7/8	4	72.89
829-200CF	20	23-3/4	22-1/16	3-3/4	99.56
829-240CF	24	29-1/4	26-7/16	5-1/4	---

REDUCER COUPLING

Socket x Socket

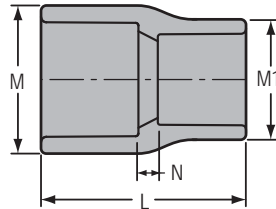

Part Number	Size	L	M	M1	N	Approx. Wt. (Lbs.)
829-101C	3/4x1/2	2-3/32	1-13/32	1-5/32	7/32	.07
829-130C	1x1/2	2-3/16	1-23/32	1-13/32	7/32	.12
829-131C	1x3/4	2-13/32	1-23/32	1-13/32	1/4	.10
829-166C	1-1/4x1/2	2-9/16	2-3/32	1-5/32	7/16	.15
829-167C	1-1/4x3/4	2-19/32	2-3/32	1-5/8	11/32	.18
829-168C	1-1/4x1	2-11/16	2-1/8	1-3/4	5/16	.15
829-209C	1-1/2x1/2	2-27/32	2-11/32	1-3/16	19/32	.20
829-210C	1-1/2x3/4	2-7/8	2-3/8	1-13/32	17/32	.19
829-211C	1-1/2x1	2-7/8	2-11/32	1-15/16	3/8	.25
829-212C	1-1/2x1-1/4	2-13/16	2-13/32	2-1/8	5/32	.23
829-247C	2x1/2	3-3/32	2-7/8	1-5/32	11/16	.31
829-248C	2x3/4	3-7/32	2-7/8	1-13/32	23/32	.32
829-249C	2x1	3-1/8	2-7/8	1-23/32	17/32	.35
829-250C	2x1-1/4	3-11/32	2-7/8	2-3/32	19/32	.33
829-251C	2x1-1/2	3-7/32	2-27/32	2-11/32	1/4	.31
829-290C ¹	2-1/2x1-1/4	3-29/32	3-1/2	2-3/8	15/16	.59
829-291C	2-1/2x1-1/2	3-3/4	3-1/2	2-3/8	19/32	.51

¹ Outlet sized with bushing



Schedule 80 CPVC Technical Information
Schedule 80 CPVC Fittings

REDUCER COUPLING

(continued)

Socket x Socket

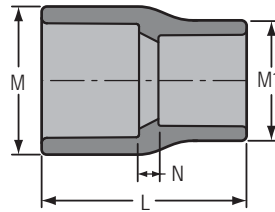

Part Number	Size	L	M	M1	N	Approx. Wt. (Lbs.)
829-292C	2-1/2x2	3-21/32	3-15/32	2-27/32	13/32	.51
829-335C	3x1	4-7/16	4-1/8	2-7/8	1-7/16	1.04
829-336C ¹	3x1-1/4	4-7/32	4-5/32	2-29/32	1-1/16	.97
829-337C	3x1-1/2	3-1/2	4-3/16	2-3/8	7/32	.71
829-338C	3x2	4	4-5/32	2-27/32	11/16	.76
829-339C	3x2-1/2	4-1/8	4-5/32	3-15/32	1/2	.79
829-339CF	3x2-1/2	6	4-1/16	3-7/16	1-3/4	1.01
829-416C ¹	4x3/4	5-23/32	5-9/32	2-29/32	2-13/32	1.78
829-417C ¹	4x1	5-15/16	5-9/32	2-29/32	2-17/32	1.54
829-419C ¹	4x1-1/2	5-23/32	5-9/32	2-29/32	2-1/16	1.68
829-420C	4x2	5-1/2	5-9/32	2-7/8	1-25/32	1.50
829-421C	4x2-1/2	4-9/16	5-3/16	3-1/2	17/32	1.35
829-422C	4x3	4-19/32	5-1/4	4-3/16	15/32	1.33
829-488CF	5x3	7-15/16	6-1/4	5-3/16	2-15/16	3.13
829-490CF	5x4	7-3/4	6-1/4	5-3/16	2-1/2	2.53
829-528C ¹	6x2	7-1/16	7-1/2	5	2-9/16	4.42
829-529C	6x2-1/2	6-31/32	7-19/32	5-9/32	2-3/16	4.72
829-530C ¹	6x3	7-1/8	7-9/16	5-9/32	2-1/4	4.25
829-530CF	6x3	9-1/4	7-5/16	5-3/16	4-3/16	4.22
829-532C	6x4	6-5/8	7-5/8	5-5/16	1-7/16	3.45
829-533CF	6x5	8-15/16	7-3/8	6-5/16	2-11/16	3.93
829-580CF	8x3	15	9-1/2	5-3/16	8-7/8	8.74
829-582C	8x4	8-29/32	9-23/32	5-1/4	2-15/32	6.47
829-582CF	8x4	14-5/8	9-1/2	5-3/16	8-1/8	9.36
829-583CF	8x5	14-11/16	9-1/2	6-5/16	7-7/16	8.30
829-585C	8x6	8	9-3/4	7-1/2	1	6.48
829-621CF	10x2	21-1/2	11-3/4	5-3/16	14-3/4	17.05
829-623CF	10x3	21-7/16	11-3/4	5-3/16	14-3/16	17.18
829-623CF	10x3	21-1/2	11-3/4	5-3/16	14-7/16	20.10
829-624CF	10x4	21-1/8	11-3/4	5-3/16	13-5/8	16.54
829-625CF	10x5	21-3/16	11-3/4	6-5/16	12-15/16	16.94
829-626C	10x6	10-19/32	12-1/32	7-19/32	2-17/32	11.43
829-626CF	10x6	17-5/8	11-3/4	7-1/2	9-1/8	15.00
829-628C	10x8	10-5/8	12	9-3/4	1-17/32	11.44
829-628CF	10x8	13-3/8	11-3/4	9-5/8	3-7/8	12.00
829-664CF	12x4	28-3/8	13-15/16	5-3/16	19-7/8	32.77
829-665CF	12x5	28-7/16	13-15/16	6-5/16	19-3/16	33.24
829-666CF	12x6	24-7/8	13-15/16	7-1/2	15-3/8	25.86
829-668C	12x8	12-5/8	14-7/32	9-3/4	2-7/16	19.26

¹ Outlet sized with bushing

Schedule 80 CPVC Technical Information
Schedule 80 CPVC Fittings



REDUCER COUPLING

(continued)

Socket x Socket

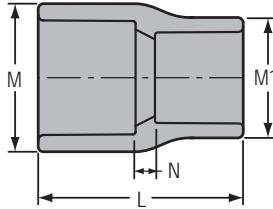

Part Number	Size	L	M	M1	N	Approx. Wt. (Lbs.)
829-668CF	12x8	20-5/8	13-15/16	9-5/8	10-1/8	24.34
829-670CF	12x10	16-3/8	13-15/16	11-15/16	4-7/8	20.77
829-694CF	14x4	30-1/8	15-3/16	5-3/16	20-7/8	32.89
829-696CF	14x6	26-5/8	15-3/16	7-1/2	16-3/8	47.58
829-698CF	14x8	22-3/8	15-3/16	9-5/8	11-1/8	27.69
829-700CF	14x10	18-1/8	15-3/16	11-15/16	5-7/8	26.86
829-702CF	14x12	17-3/4	15-3/8	14-1/8	4-1/2	29.14
829-754CF	16x4	38	17-3/8	5-3/16	27-3/4	50.97
829-756CF	16x6	34-1/2	17-3/8	7-1/2	23-1/4	61.20
829-758CF	16x8	30-1/4	17-3/8	9-5/8	18	54.00
829-760CF	16x10	26	17-3/8	11-15/16	12-3/4	51.35
829-762CF	16x12	20-1/4	17-3/8	14-1/8	6	65.63
829-764CF	16x14	21-1/4	17-1/2	15-1/2	5-1/4	50.00
829-784CF	18x4	47-3/8	19-11/16	5-3/16	36-1/8	107.14
829-786CF	18x6	43-7/8	19-11/16	7-1/2	31-5/8	105.76
829-788CF	18x8	39-5/8	19-11/16	9-5/8	26-3/8	101.60
829-790CF	18x10	35-3/8	19-11/16	11-15/16	21-1/8	89.54
829-792CF	18x12	29-5/8	19-11/16	14-1/8	14-3/8	76.67
829-794CF	18x14	29-5/8	19-11/16	15-1/2	13-5/8	87.00
829-796CF	18x16	23	19-11/16	17-11/16	6	63.70
829-814CF	20x4	58	21-7/8	5-3/16	45-3/4	159.76
829-816CF	20x6	54-1/2	21-7/8	7-1/2	41-1/4	158.17
829-818CF	20x8	50-1/4	21-7/8	9-5/8	36	154.50
829-820CF	20x10	46	21-7/8	11-15/16	30-3/4	146.56
829-822CF	20x12	40-1/4	21-7/8	14-1/8	24	137.46
829-824CF	20x14	40-1/4	21-7/8	15-1/2	23-1/4	---
829-826CF	20x16	33-5/8	21-7/8	17-11/16	15-5/8	115.51
829-828CF	20x18	25-1/2	21-7/8	19-7/8	6-1/2	---
829-904CF	24x4	71-1/2	26-1/16	5-3/16	57-1/4	241.69
829-906CF	24x6	68	26-1/16	7-1/2	52-3/4	240.34
829-908CF	24x8	63-3/4	26-1/16	9-5/8	47-1/2	236.18
829-910CF	24x10	59-1/2	26-1/16	11-15/16	42-1/4	270.28
829-912CF	24x12	53-3/4	26-1/16	14-1/8	35-1/2	219.13
829-914CF	24x14	53-3/4	26-1/16	15-1/2	34-3/4	---
829-916CF	24x16	47-1/8	26-1/16	17-11/16	27-1/8	179.54
829-918CF	24x18	39	26-1/16	19-7/8	18	167.74
829-920CF	24x20	30-5/8	26-1/16	22-1/16	8-5/8	139.32





Schedule 80 CPVC Technical Information
Schedule 80 CPVC Fittings

ECCENTRIC REDUCER COUPLING

Socket x Socket

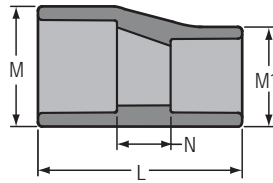

Part Number	Size	L	M	M1	N	Approx. Wt. (Lbs.)
829-101CFE	3/4x1/2	3-3/8	1-3/8	1-1/8	1-5/8	.09
829-130CFE	1x1/2	3-1/2	1-5/8	1-1/8	1-1/2	.11
829-131CFE	1x3/4	4	1-5/8	1-3/8	1-3/4	.15
829-168CFE	1-1/4x1	5-1/8	2	1-11/16	2-3/8	.30
829-209CFE	1-1/2x1/2	7-1/8	2-1/4	1-1/8	4-7/8	.33
829-210CFE	1-1/2x3/4	7-5/8	2-1/4	1-3/8	5-1/8	.34
829-211CFE	1-1/2x1	5-3/8	2-1/4	1-11/16	2-5/8	.35
829-212CFE	1-1/2x1-1/4	4-9/16	2-5/16	2-1/16	1-9/16	.33
829-249CFE	2x1	6-1/8	2-3/4	1-11/16	3-1/8	.37
829-250CFE	2x1-1/4	6-1/8	2-3/4	2-1/16	2-7/8	.46
829-251CFE	2x1-1/2	6	2-3/4	2-5/16	2-3/4	.47
829-289CFE	2-1/2x1	10-5/8	3-5/16	1-11/16	7-3/8	.90
829-290CFE	2-1/2x1-1/4	10-5/8	3-5/16	2-1/16	7-1/8	1.15
829-291CFE	2-1/2x1-1/2	10-1/2	3-5/16	2-5/16	7	1.24
829-292CFE	2-1/2x2	6-7/8	3-5/16	2-13/16	3-1/8	.86
829-335CFE	3x1	11-7/8	3-15/16	1-11/16	8-3/8	1.58
829-336CFE	3x1-1/4	11-7/8	3-15/16	2-1/16	8-1/8	1.27
829-337CFE	3x1-1/2	11-3/4	3-15/16	2-5/16	8	1.41
829-338CFE	3x2	5-7/8	4-5/32	2-7/8	2-15/32	1.07
829-339CFE	3x2-1/2	7-1/4	4-1/16	3-7/16	3	1.26
829-417CFE	4x1	17	5-1/8	1-11/16	13-1/2	3.48
829-418CFE	4x1-1/4	17	5-1/8	2-1/16	13-1/4	3.00
829-419CFE	4x1-1/2	16-7/8	5-1/8	2-5/16	13-1/8	2.60
829-420CFE	4x2	13-1/4	5-1/8	2-13/16	9-1/4	2.47
829-421CFE	4x2-1/2	12-3/8	5-1/8	3-7/16	8-1/8	2.58
829-422CFE	4x3	8-3/4	5-1/8	4-1/8	4-1/4	2.04
829-528CFE	6x2	20-7/8	7-5/16	2-13/16	15-7/8	7.02
829-529CFE	6x2-1/2	20	7-5/16	3-7/16	14-3/4	7.48
829-530CFE	6x3	16-3/8	7-5/16	4-1/8	10-7/8	6.16
829-532CFE	6x4	11-1/8	7-5/16	5-3/16	5-5/8	4.43
829-533CFE	6x5	11-1/4	7-3/8	6-5/16	5	6.44
829-578CFE	8x2	30-5/8	9-1/2	2-13/16	24-5/8	17.32
829-580CFE	8x3	26-1/8	9-1/2	4-1/8	19-5/8	16.42
829-582CFE	8x4	20-7/8	9-1/2	5-3/16	14-3/8	13.59
829-583CFE	8x5	21	9-1/2	6-5/16	13-3/4	11.81
829-585CFE	8x6	15-1/4	9-1/2	7-1/2	7-3/4	9.78
829-624CFE	10x4	32	11-3/4	5-3/16	24-1/2	29.89
829-625CFE	10x5	32-1/8	11-3/4	6-5/16	23-7/8	27.68
829-626CFE	10x6	26-3/8	11-3/4	7-1/2	17-7/8	25.59
829-628CFE	10x8	18-1/16	11-3/4	9-5/8	8-9/16	17.28
829-664CFE	12x4	43-1/2	13-15/16	5-3/16	35	56.73

Schedule 80 CPVC Technical Information
Schedule 80 CPVC Fittings



ECCENTRIC REDUCER COUPLING (continued)
 Socket x Socket

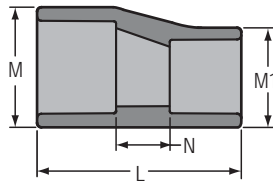

Part Number	Size	L	M	M1	N	Approx. Wt. (Lbs.)
829-665CFE	12x5	43-5/8	13-15/16	6-5/16	34-3/8	42.50
829-666CFE	12x6	37-7/8	13-15/16	7-1/2	28-3/8	52.43
829-668CFE	12x8	29-9/16	13-15/16	9-5/8	19-1/16	34.80
829-670CFE	12x10	20-5/8	13-15/16	11-15/16	9-1/8	26.06
829-696CFE	14x6	41-3/8	15-3/16	7-1/2	31-1/8	67.95
829-698CFE	14x8	33-1/16	15-3/16	9-5/8	21-13/16	39.32
829-700CFE	14x10	24-1/8	15-3/16	11-15/16	11-7/8	60.41
829-702CFE	14x12	20-1/8	15-3/8	14-1/8	6-7/8	41.52
829-756CFE	16x6	54-1/4	17-1/2	7-1/2	43	96.99
829-758CFE	16x8	45-15/16	17-1/2	9-5/8	33-11/16	91.61
829-760CFE	16x10	37	17-1/2	11-15/16	23-3/4	85.11
829-762CFE	16x12	33	17-1/2	14-1/8	18-3/4	71.78
829-764CFE	16x14	24-5/8	17-1/2	15-1/2	9-5/8	59.26
829-786CFE	18x6	69-1/4	19-11/16	7-1/2	57	164.92
829-788CFE	18x8	60-15/16	19-11/16	9-5/8	47-11/16	152.22
829-790CFE	18x10	52	19-11/16	11-15/16	37-3/4	148.37
829-792CFE	18x12	48	19-11/16	14-1/8	32-3/4	132.56
829-794CFE	18x14	39-5/8	19-11/16	15-1/2	23-5/8	111.06
829-796CFE	18x16	28-5/8	19-11/16	17-11/16	11-5/8	85.64



FABRICATED REPAIR COUPLING
 Gasket x Gasket

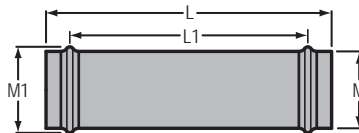

Part Number	Size	L	L1	M	M1	Approx. Wt. (Lbs.)
828-020CF	2	9-1/8	11-3/4	4-1/8	4-5/8	.97
828-030CF	3	15-1/2	11-3/4	4-1/8	4-5/8	3.39
828-040CF	4	19-1/2	15	5-3/16	5-3/4	6.54
828-060CF	6	23	16	7-1/2	8-1/8	13.41
828-080CF	8	26-5/8	19-11/16	9-5/8	10-3/8	21.45
828-100CF	10	28	21-1/4	10-3/4	12-1/4	---
828-120CF	12	30	22-1/2	14-1/8	16-1/8	---
828-140CF	14	19	11-1/2	15-1/2	16-3/8	45.50
828-160CF	16	21-5/8	12-3/8	17-11/16	18-3/4	60.00



Schedule 80 CPVC Technical Information
Schedule 80 CPVC Fittings

COUPLING

Fipt x Fipt

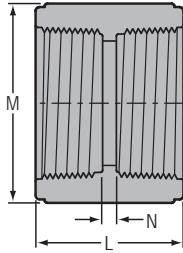

Part Number	Size	L	M	N	Approx. Wt. (Lbs.)
830-002C	1/4	1-11/32	13/16	5/32	.02
830-003C	3/8	1-15/32	1	9/32	.04
830-005C	1/2	1-5/8	1-9/32	1/4	.07
830-007C	3/4	1-11/16	1-5/8	3/32	.09
830-010C	1	2-3/32	1-15/16	1/8	.15
830-012C	1-1/4	2-3/16	2-9/32	3/16	.22
830-015C	1-1/2	2-7/32	2-5/8	3/16	.30
830-020C	2	2-7/32	3	7/32	.35
830-025C	2-1/2	3-5/16	3-9/16	1/8	.71
830-030C	3	3-15/32	4-3/8	21/32	1.13
830-040C	4	3-21/32	5-9/16	3/16	1.61
830-060CF	6	3-3/4	7-3/16	3/4	1.76
830-080CF	8	4-1/2	9-3/8	1-1/16	3.33

SPECIAL REINFORCED COUPLING

SR Fipt x SR Fipt

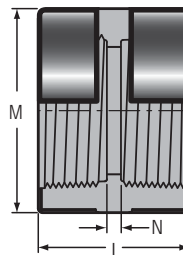

Part Number	Size	L	M	N	Approx. Wt. (Lbs.)
830-005CSR	1/2	1-19/32	1-7/32	9/32	.06
830-007CSR	3/4	1-5/8	1-3/8	1/8	.07
830-010CSR	1	1-15/16	1-23/32	1/16	.13
830-012CSR	1-1/4	2-1/16	2-1/16	5/16	.17
830-015CSR	1-1/2	2-5/32	2-7/16	11/32	.25
830-020CSR	2	2-1/4	3-1/32	1/4	.39

Schedule 80 CPVC Technical Information
Schedule 80 CPVC Fittings



REDUCER COUPLING

Fipt x Fipt

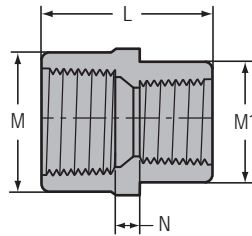

Part Number	Size	L	M	M1	N	Approx. Wt. (Lbs.)
830-072C ¹	1/2x1/4	1-31/32	1-5/16	1-5/32	5/8	.08
830-073C ¹	1/2x3/8	1-29/32	1-7/32	1-7/32	19/32	.08
830-101C	3/4x1/2	1-23/32	1-3/8	1-7/32	7/32	.08

¹ Outlet sized with bushing

SPECIAL REINFORCED REDUCER COUPLING

SR Fipt x SR Fipt

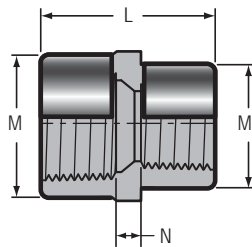

Part Number	Size	L	M	M1	N	Approx. Wt. (Lbs.)
830-101CSR	3/4x1/2	1-23/32	1-3/8	1-7/32	7/32	.09
830-130CSR	1x1/2	2-1/4	1-23/32	1-7/32	21/32	.17
830-131CSR	1x3/4	2-13/32	1-23/32	1-3/8	23/32	.17
830-210CSR	1-1/2x3/4	2-7/8	2-7/16	1-3/8	1-7/32	.29
830-211CSR	1-1/2x1	2-15/16	2-7/16	1-11/16	7/16	.36
830-212CSR	1-1/2x1-1/4	2-7/8	2-1/2	2-3/32	15/16	.34
830-249CSR	2x1	3-3/16	3	1-23/32	1-17/32	.48
830-251CSR	2x1-1/2	3-1/4	3	2-7/16	1-7/16	.52

GROOVED COUPLING ADAPTER

Groove x Socket

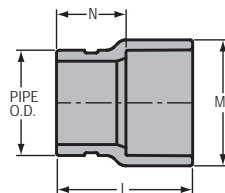

Part Number	Size	L	M1	N	Approx. Wt. (Lbs.)
833-012C	1-1/4	2-13/16	2-1/16	1-9/16	.17
833-015C	1-1/2	2-29/32	2-11/32	1-1/2	.20
833-020C	2	3-1/16	2-7/8	1-9/16	.30
833-025C	2-1/2	3-3/8	3-1/2	1-5/8	.52
833-030C	3	3-9/16	4-3/16	1-11/16	.72



Schedule 80 CPVC Technical Information
Schedule 80 CPVC Fittings

GROOVED COUPLING ADAPTER

Groove x Socket

(continued)

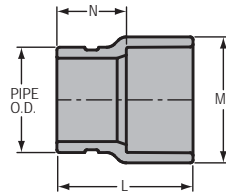

Part Number PVC	Size	L	M1	N	Approx. Wt. (Lbs.)
					PVC
833-040C	4	4-17/32	5-1/4	2-9/32	1.38
833-050CF	5	7	6-5/16	4	2.35
833-060C	6	5-5/16	7-9/16	2-5/16	3.00
833-080CF	8	8-3/16	9-5/8	3-15/16	7.16
833-100CF	10	9-7/8	11-15/16	4-5/8	10.72
833-120CF	12	10-7/8	14-1/8	4-5/8	24.11



FEMALE ADAPTER

Socket x Fipt

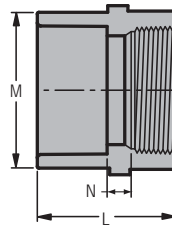

Part Number	Size	L	M	N	Approx. Wt. (Lbs.)
835-002C	1/4	1-11/32	27/32	3/32	.02
835-003C	3/8	1-15/32	1	3/32	.04
835-005C	1/2	1-3/4	1-5/32	3/32	.06
835-007C	3/4	1-27/32	1-13/32	3/32	.08
835-010C	1	2-1/8	1-23/32	3/32	.14
835-012C	1-1/4	2-5/16	2-3/32	3/32	.22
835-015C	1-1/2	2-1/2	2-11/32	3/32	.21
835-020C	2	3	3-1/32	1/4	.42
835-025C	2-1/2	3-1/4	3-9/16	7/32	.67
835-030C	3	3-15/32	4-1/4	3/16	.76
835-040C	4	3-31/32	5-7/32	1/4	1.71
835-060C	6	4-31/32	7-21/32	5/16	3.22
835-080C	8	6-5/32	9-23/32	1/4	5.39
835-080CF	8	8-9/16	9-5/8	2-9/16	6.56
835-100CF	10	10-1/4	11-15/16	3	11.59
835-120CF	12	11-1/8	14-1/8	2-5/8	20.00

Schedule 80 CPVC Technical Information
Schedule 80 CPVC Fittings



SPECIAL REINFORCED FEMALE ADAPTER

Socket x SR Fipt

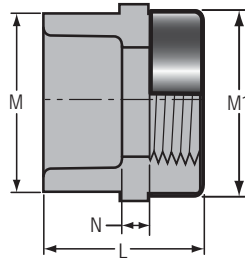

Part Number	Size	L	M	M1	N	Approx. Wt. (Lbs.)
835-002CSR	1/4	1-13/32	27/32	27/32	3/32	.03
835-003CSR	3/8	1-15/32	15/16	31/32	3/32	.04
835-005CSR	1/2	1-3/4	1-5/32	1-3/16	3/16	.07
835-007CSR	3/4	1-7/8	1-13/32	1-3/8	3/32	.09
835-010CSR	1	2-1/8	1-11/16	1-23/32	3/32	.14
835-012CSR	1-1/4	2-5/16	2-3/32	2-1/16	3/32	.20
835-015CSR	1-1/2	2-7/16	2-13/32	2-7/16	7/32	.28
835-020CSR	2	2-23/32	3	3-1/32	1/4	.45
835-025CSR	2-1/2	3-1/4	3-9/16	3-9/16	11/32	.70
835-030CSR	3	3-1/2	4-1/4	4-9/32	7/32	1.01
835-040CSR	4	3-31/32	5-7/32	5-1/4	7/32	1.35
835-060CSR	6	4-31/32	7-5/8	7-21/32	1/4	3.25



REDUCING FEMALE ADAPTER

Socket x SR Fipt

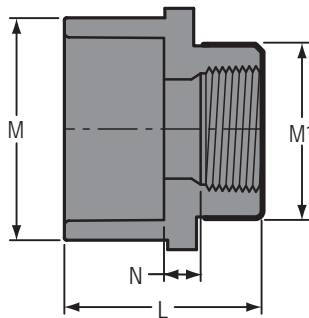

Part Number	Size	L	M	M1	N	Approx. Wt. (Lbs.)
835-098C	3/4x1/4	1-15/16	1-13/32	27/32	---	.06



Schedule 80 CPVC Technical Information
Schedule 80 CPVC Fittings

**SPECIAL REINFORCED
 REDUCING FEMALE ADAPTER**

Socket x SR Fipt

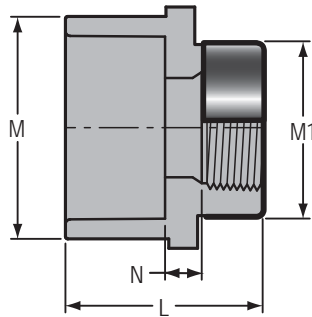

Part Number	Size	L	M	M1	N	Approx. Wt. (Lbs.)
835-074CSR	1/2x3/4	1-3/4	1-3/16	1-3/8	7/32	.08
835-098CSR	3/4x1/4	1-15/16	1-13/32	27/32	13/32	.07
835-101CSR	3/4x1/2	1-7/8	1-3/8	1-3/16	3/16	.08
835-102CSR	3/4x1	2-1/16	1-7/16	1-11/16	7/32	.13
835-130CSR	1x1/2	2	1-11/16	1-3/16	7/32	.11
835-131CSR	1x3/4	2-3/32	1-3/4	1-3/8	1/4	.13

TRANSITION FEMALE ADAPTER

Socket x Brass Fipt

Dimensions Also Applicable to 835-XXXSS

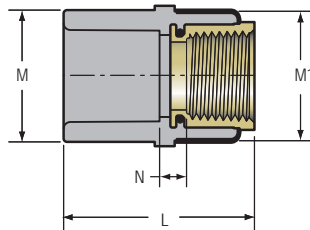

Part Number	Size	L	M	M1	N	Approx. Wt. (Lbs.)
835-005CBR	1/2	1-25/32	1-5/32	1-7/32	5/8	.12
835-007CBR	3/4	2	1-13/32	1-3/8	3/8	.24
835-010CBR	1	2-7/32	1-3/4	1-11/16	13/32	.31
835-012CBR	1-1/4	2-3/8	2-3/32	2-1/16	3/8	.36
835-015CBR	1-1/2	2-17/32	2-13/32	2-7/16	13/32	.48
835-020CBR	2	2-25/32	2-7/8	3-3/16	7/16	1.05

Not intended to convey or dispense water for human consumption through drinking or cooking

**TRANSITION REDUCING
 FEMALE ADAPTER**

Socket x Brass Fipt

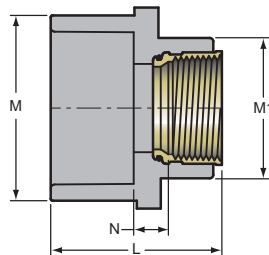

Part Number	Size	L	M	M1	N	Approx. Wt. (Lbs.)
835-101CBR	3/4x1/2	2-1/32	1-7/16	1-3/16	15/32	.18

Not intended to convey or dispense water for human consumption through drinking or cooking

Schedule 80 CPVC Technical Information
Schedule 80 CPVC Fittings



ENCAPSULATED SPECIAL REINFORCED FEMALE ADAPTER

Socket x ESR Fipt

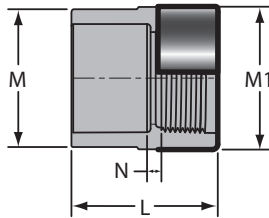

Part Number	Size	L	M	M1	N	Approx. Wt. (Lbs.)
835-002CESR	1/4	1-1/2	27/32	29/32	3/32	.05
835-003CESR	3/8	1-17/32	15/16	1-1/32	3/16	.04
835-005CESR	1/2	1-7/8	1-3/16	1-9/32	9/32	.07
835-007CESR	3/4	2	1-13/32	1-15/32	1/8	.11
835-010CESR	1	2-1/4	1-3/4	1-13/16	1/8	.15
835-012CESR	1-1/4	2-7/16	2-1/8	2-5/32	3/16	.22
835-015CESR	1-1/2	2-9/16	2-13/32	2-1/2	1/4	.31
835-020CESR	2	2-27/32	3	3-3/32	13/32	.49

MALE ADAPTER

Spigot x Mipt

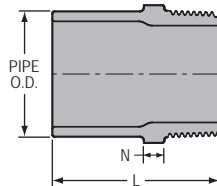

Part Number	Size	L	N	Approx. Wt. (Lbs.)
861-005C	1/2	1-13/16	5/16	.03
861-007C	3/4	1-31/32	5/16	.05
861-010C	1	2-3/32	1/4	.08
861-131C	1x3/4	2	1/4	.07
861-012C	1-1/4	2-9/32	9/32	.13
861-015C	1-1/2	2-5/8	11/32	.15
861-020C	2	2-13/16	13/32	.24

SPECIAL REINFORCED SPIGOT FEMALE ADAPTER

Spigot x SR Fipt

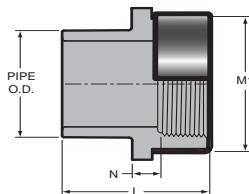

Part Number	Size	L	M1	N	Approx. Wt. (Lbs.)
878-005CSR	1/2	1-3/4	1-3/16	5/32	.06
878-007CSR	3/4	1-15/16	1-3/8	3/16	.08
878-010CSR	1	2-1/4	1-11/16	7/32	.13
878-012CSR	1-1/4	2-15/32	2-1/16	1/4	.19
878-015CSR	1-1/2	2-21/32	2-7/16	13/32	.26



Schedule 80 CPVC Technical Information
Schedule 80 CPVC Fittings

**SPECIAL REINFORCED SPIGOT
 FEMALE ADAPTER (continued)**

Spigot x SR Fipt

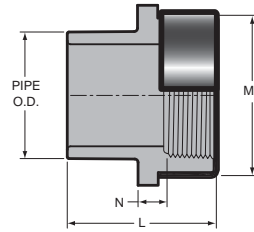

Part Number	Size	L	M1	N	Approx. Wt. (Lbs.)
878-020CSR	2	2-13/16	3	3/8	.40
878-030CSR	3	3-27/32	4-9/32	17/32	.97
878-040CSR	4	4-3/8	5-1/4	5/8	1.42

**SPECIAL REINFORCED REDUCING
 SPIGOT FEMALE ADAPTER**

Spigot x SR Fipt

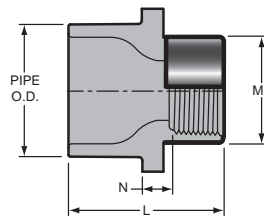

Part Number	Size	L	M1	N	Approx. Wt. (Lbs.)
878-072CSR	1/2x1/4	1-13/32	27/32	3/16	.03
878-098CSR	3/4x1/4	1-27/32	27/32	7/32	.06
878-128CSR	1x1/4	2-3/8	27/32	21/32	.09

**ENCAPSULATED SPECIAL REINFORCED
 SPIGOT FEMALE ADAPTER**

Spigot x ESR Fipt

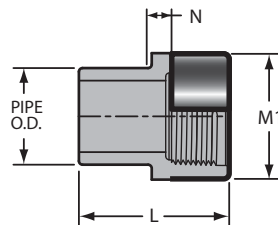

Part Number	Size	L	M1	N	Approx. Wt. (Lbs.)
878-005CESR	1/2	1-7/8	1-9/32	3/16	.07
878-007CESR	3/4	2-1/16	1-15/32	3/8	.09
878-010CESR	1	2-3/8	1-25/32	11/32	.15
878-012CESR	1-1/4	2-19/32	2-5/32	5/16	.20
878-015CESR	1-1/2	2-3/4	2-1/2	13/32	.29
878-020CESR	2	2-15/16	3-3/32	5/16	.44

Schedule 80 CPVC Technical Information
Schedule 80 CPVC Fittings



TRANSITION FEMALE ADAPTER

Spigot x Brass Fipt

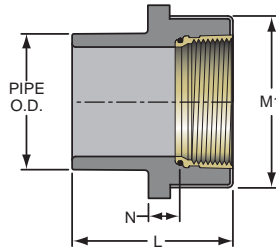

Part Number	Size	L	M1	N	Approx. Wt. (Lbs.)
878-010CBR	1	2-9/32	1-23/32	13/32	.23

Not intended to convey or dispense water for human consumption through drinking or cooking

MALE ADAPTER

Mipt x Socket

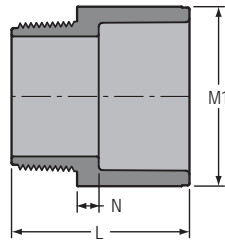

Part Number	Size	L	M1	N	Approx. Wt. (Lbs.)
836-005C	1/2	1-23/32	1-5/32	3/16	.05
836-007C	3/4	1-27/32	1-7/16	7/32	.06
836-010C	1	2-5/32	1-23/32	7/32	.10
836-012C	1-1/4	2-1/4	2-1/8	1/32	.16
836-015C	1-1/2	2-9/16	2-13/32	9/32	.19
836-020C	2	2-7/8	2-7/8	5/16	.31
836-025C	2-1/2	3-21/32	3-17/32	11/32	.54
836-030C	3	3-7/8	4-1/4	3/8	.78
836-040C	4	4-13/32	5-5/16	13/32	1.18
836-050CF	5	6	6-5/16	1-5/8	2.22
836-060C	6	5-1/2	7-9/16	19/32	3.04
836-080CF	8	8-3/16	9-5/8	2-3/16	5.95
836-100CF	10	10-3/8	11-15/16	3-3/16	10.95
836-120CF	12	11-1/8	14-1/8	2-3/4	19.99





Schedule 80 CPVC Technical Information
Schedule 80 CPVC Fittings

REDUCING MALE ADAPTER

Mipt x Socket

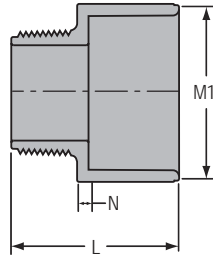

Part Number	Size	L	M1	N	Approx. Wt. (Lbs.)
836-102C	3/4x1	2-9/32	1-3/4	17/32	.10
836-131C	1x3/4	2-1/16	1-13/32	1/4	.07

REINFORCED MALE ADAPTER

Rmipt x Socket

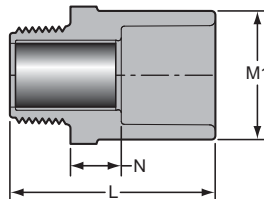

Part Number	Size	L	M1	N	Approx. Wt. (Lbs.)
836-005CR	1/2	2-3/32	1-5/32	9/16	.06
836-007CR	3/4	2-1/4	1-3/8	9/16	.09
836-010CR	1	2-21/32	1-23/32	11/16	.15

TRANSITION MALE ADAPTER

Brass Mipt x Socket

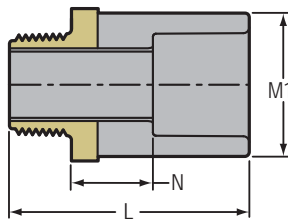

Part Number	Size	L	M1	N	Approx. Wt. (Lbs.)
836-005CBR	1/2	2-13/32	1-9/32	27/32	.20
836-007CBR	3/4	2-17/32	1-13/32	13/16	.26
836-010CBR	1	2-15/16	1-23/32	29/32	.43
836-012CBR	1-1/4	3-1/8	2-3/32	31/32	.66
836-015CBR	1-1/2	3-9/32	2-11/32	1	.80
836-020CBR	2	3-7/16	2-27/32	31/32	1.01

Schedule 80 CPVC Technical Information
Schedule 80 CPVC Fittings



REDUCER BUSHING

Flush Style

Spigot x Socket

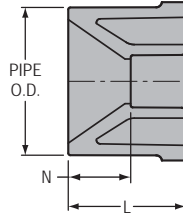

Part Number	Size	L	N	Approx. Wt. (Lbs.)
837-052C	3/8x1/4	31/32	5/16	.01
837-072C	1/2x1/4	1-3/32	13/32	.02
837-073C	1/2x3/8	1-1/8	11/32	.02
837-101C	3/4x1/2	1-7/32	11/32	.03
837-129C ¹	1x3/8	1-5/8	27/32	.10
837-130C	1x1/2	1-11/32	11/32	.07
837-131C	1x3/4	1-11/32	5/16	.04
837-166C	1-1/4x1/2	1-1/2	5/8	.12
837-167C	1-1/4x3/4	1-1/2	1/2	.10
837-168C	1-1/4x1	1-19/32	15/32	.09
837-209C	1-1/2x1/2	1-23/32	13/16	.15
837-210C	1-1/2x3/4	1-5/8	5/8	.16
837-211C	1-1/2x1	1-9/16	13/32	.13
837-212C	1-1/2x1-1/4	1-9/16	9/32	.07
837-247C	2x1/2	1-29/32	1	.30
837-248C	2x3/4	1-29/32	21/32	.23
837-249C	2x1	1-25/32	5/8	.25
837-250C	2x1-1/4	1-11/16	7/16	.23
837-251C	2x1-1/2	1-3/4	11/32	.16
837-289C	2-1/2x1	2-1/32	29/32	.39
837-290C	2-1/2x1-1/4	2-5/32	13/32	.41
837-291C	2-1/2x1-1/2	2-5/32	3/4	.40
837-292C	2-1/2x2	2-1/16	17/32	.30
837-334C ¹	3x3/4	2-9/16	1-17/32	.74
837-335C	3x1	2-9/32	1-1/8	.70
837-336C	3x1-1/4	2-1/4	1	.70
837-337C	3x1-1/2	2-9/32	7/8	.67
837-338C	3x2	2-7/32	23/32	.64
837-339C	3x2-1/2	2-5/16	1/4	.43
837-416C ¹	4x3/4	2-27/32	1-27/32	1.37
837-418C ¹	4x1-1/4	3-9/16	1-11/16	1.38
837-420C	4x2	2-21/32	1-1/8	1.13

¹ Outlet sized with bushing





Schedule 80 CPVC Technical Information
Schedule 80 CPVC Fittings

REDUCER BUSHING (continued)

Flush Style

Spigot x Socket

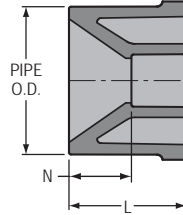

Part Number	Size	L	N	Approx. Wt. (Lbs.)
837-422C	4x3	2-9/16	11/16	.86
837-490C	5x4	2-31/32	23/32	---
837-490CF	5x4	3	3/4	1.50
837-525C ¹	6x1	3-31/32	2-13/16	3.28
837-527C ¹	6x1-1/2	3-3/4	2-11/32	3.02
837-528C	6x2	3-17/32	2-1/32	3.00
837-529C ¹	6x2-1/2	3-29/32	2-5/32	3.45
837-530C	6x3	3-17/32	2-1/8	3.05
837-532C	6x4	3-9/16	1-1/4	2.95
837-533CF	6x5	3	3/8	1.94
837-578C ¹	8x2	4-15/16	3-3/8	8.99
837-580C ¹	8x3	5-1/8	3-1/4	8.81
837-582C	8x4	4-1/2	2-1/4	9.01
837-585C	8x6	4-3/8	1-3/8	5.15
837-624C ¹	10x4	6	3-3/4	11.36
837-626C	10x6	5-5/16	2-5/16	9.92
837-628C	10x8	5-11/32	1-5/16	9.04
837-666CF	12x6	6-7/16	3-3/8	19.45
837-668C	12x8	6-7/8	2-7/16	10.82
837-670CF	12x10	6-11/32	19/32	11.78
837-696CF	14x6	7-3/4	4-3/4	37.74
837-698CF	14x8	7-1/2	3-7/16	32.02
837-700CF	14x10	7	2	22.64
837-702CF	14x12	7	1	9.40
837-756CF	16x6	8-3/4	5-3/4	67.03
837-758CF	16x8	8-1/2	4-7/16	61.33
837-760CF	16x10	8	3	44.88
837-762CF	16x12	8	2	27.95
837-764CF	16x14	8	1	20.00
837-788CF	18x8	9-1/2	5-7/16	---
837-790CF	18x10	9	4	97.24

¹ Outlet sized with bushing

Schedule 80 CPVC Technical Information
Schedule 80 CPVC Fittings



REDUCER BUSHING (continued)

Flush Style

Spigot x Socket

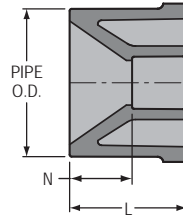

Part Number	Size	L	N	Approx. Wt. (Lbs.)
837-792CF	18x12	9	3	84.92
837-794CF	18x14	9	2	56.27
837-796CF	18x16	9	1	34.00

REDUCER BUSHING

Flush Style

Spigot x Fipt

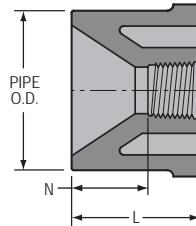

Part Number	Size	L	N	Approx. Wt. (Lbs.)
838-052C	3/8x1/4	31/32	3/8	.01
838-071C	1/2x1/8	1	9/16	.02
838-072C	1/2x1/4	1	7/8	.02
838-073C	1/2x3/8	1-3/32	17/32	.02
838-098C	3/4x1/4	1-7/32	5/8	.04
838-099C	3/4x3/8	1-1/4	21/32	.04
838-101C	3/4x1/2	1-7/32	15/32	.03
838-129C	1x3/8	1-13/32	19/32	.07
838-130C	1x1/2	1-5/32	21/32	.06
838-131C	1x3/4	1-3/8	21/32	.06
838-166C	1-1/4x1/2	1-17/32	3/4	12
838-167C	1-1/4x3/4	1-7/16	23/32	.10
838-168C	1-1/4x1	1-17/32	5/8	.09





Schedule 80 CPVC Technical Information
Schedule 80 CPVC Fittings

REDUCER BUSHING (continued)

Flush Style

Spigot x Fipt

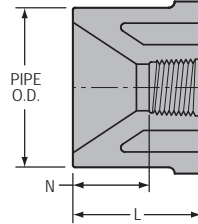

Part Number	Size	L	N	Approx. Wt. (Lbs.)
838-207C	1-1/2x1/4	1-9/16	1-3/16	.14
838-209C	1-1/2x1/2	1-11/16	31/32	.17
838-210C	1-1/2x3/4	1-9/16	27/32	.18
838-211C	1-1/2x1	1-23/32	13/16	.16
838-212C	1-1/2x1-1/4	1-1/2	9/16	.10
838-247C	2x1/2	1-29/32	1-5/32	.27
838-248C	2x3/4	1-7/8	1-5/32	.27
838-249C	2x1	1-29/32	1	.27
838-250C	2x1-1/4	1-19/32	21/32	.25
838-251C	2x1-1/2	1-9/16	5/8	.20
838-287C	2-1/2x1/2	2-3/8	1-21/32	.46
838-288C	2-1/2x3/4	2-7/16	1-5/8	.48
838-289C	2-1/2x1	2-5/32	1-1/4	.48
838-290C	2-1/2x1-1/4	2-13/32	1-3/8	.45
838-291C	2-1/2x1-1/2	2-3/8	1-13/32	.50
838-292C	2-1/2x2	2-1/16	1-1/16	.33
838-334C	3x3/4	2-9/32	1-1/2	.63
838-335C	3x1	2-9/32	1-11/32	.63
838-336C	3x1-1/4	2-1/4	1-3/8	.61
838-337C	3x1-1/2	2-1/4	1-5/8	.62
838-338C	3x2	2-3/16	1-7/32	.58
838-339C	3x2-1/2	2-3/8	3/4	.50
838-420C	4x2	2-11/16	1-21/32	1.20
838-421C	4x2-1/2	2-21/32	1-1/16	1.15
838-422C	4x3	2-5/8	1	.85
838-528C	6x2	3-17/32	2-1/2	3.04
838-530C	6x3	3-17/32	2-1/8	3.14
838-532C	6x4	3-17/32	2-1/32	2.68

Schedule 80 CPVC Technical Information
Schedule 80 CPVC Fittings



**SPECIAL REINFORCED
REDUCER BUSHING**

Flush Style

Spigot x SR Fipt

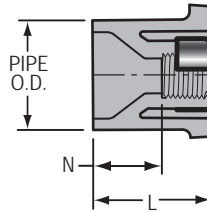

Part Number	Size	L	N	Approx. Wt. (Lbs.)
838-128CSR	1x1/4	1-13/32	25/32	.08
838-207CSR	1-1/2x1/4	1-9/16	1	.14
838-209CSR	1-1/2x1/2	1-23/32	31/32	.18
838-210CSR	1-1/2x3/4	1-9/16	13/16	.15
838-247CSR	2x1/2	1-29/32	1-5/32	.25
838-248CSR	2x3/4	1-29/32	1-5/32	.28
838-249CSR	2x1	1-7/8	31/32	.27
838-334CSR	3x3/4	2-9/32	1-17/32	.63
838-335CSR	3x1	2-9/32	1-11/32	.63
838-336CSR	3x1-1/4	2-1/4	1-5/16	.63
838-337CSR	3x1-1/2	2-1/4	1-3/8	.64
838-528CSR	6x2	3-1/2	2-9/16	2.96
838-530CSR	6x3	3-17/32	2-1/8	3.07
838-532CSR	6x4	3-1/2	1-15/16	2.62



REDUCER T.T. BUSHING

Flush Style

Mipt x Fipt

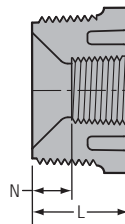

Part Number	Size	L	N	Approx. Wt. (Lbs.)
839-041C	1/4x1/8	23/32	11/32	.01
839-052C	3/8x1/4	13/16	1/8	.01



Schedule 80 CPVC Technical Information
Schedule 80 CPVC Fittings

REDUCER T.T. BUSHING (continued)

Flush Style

Mipt x Fipt

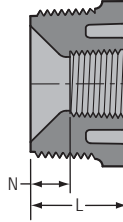

Part Number	Size	L	N	Approx. Wt. (Lbs.)
839-072C	1/2x1/4	29/32	9/32	.02
839-073C	1/2x3/8	15/16	11/32	.01
839-098C	3/4x1/4	1-1/32	7/16	.04
839-099C	3/4x3/8	1-1/32	7/16	.03
839-101C	3/4x1/2	15/16	3/16	.02
839-128C	1x1/4	1-1/8	17/32	.06
839-129C	1x3/8	1-7/32	5/8	.06
839-130C	1x1/2	1-1/16	5/16	.06
839-131C	1x3/4	1-1/8	13/32	.04
839-166C	1-1/4x1/2	1-5/16	9/16	.11
839-167C	1-1/4x3/4	1-9/32	9/16	.09
839-168C	1-1/4x1	1-9/32	1-1/32	.06
839-209C	1-1/2x1/2	1-11/32	19/32	.13
839-210C	1-1/2x3/4	1-11/32	19/32	.13
839-211C	1-1/2x1	1-11/32	13/32	.11
839-212C	1-1/2x1-1/4	1-11/32	13/32	.07
839-247C	2x1/2	1-3/8	21/32	.18
839-248C	2x3/4	1-3/8	5/8	.18
839-249C	2x1	1-3/8	15/32	.19
839-250C	2x1-1/4	1-3/8	7/16	.17
839-251C	2x1-1/2	1-3/8	13/32	.13
839-292C	2-1/2x2	1-29/32	7/8	.23
839-337C	3x1-1/2	1-15/16	29/32	.52
839-338C	3x2	1-15/16	15/16	.47
839-339C	3x2-1/2	1-15/16	5/8	.39
839-420C	4x2	2-1/8	1-1/8	.87
839-422C	4x3	2-1/8	1/2	.74
839-532C	6x4	3-17/32	1-13/16	2.78

Schedule 80 CPVC Technical Information
Schedule 80 CPVC Fittings



**SPECIAL REINFORCED
 REDUCER T.T. BUSHING**

Mipt x SR Fipt

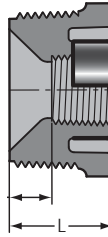

Part Number	Size	L	N	Approx. Wt. (Lbs.)
839-209CSR	1-1/2x1/2	1-11/32	19/32	.13
839-210CSR	1-1/2x3/4	1-11/32	19/32	.13
839-247CSR	2x1/2	1-3/8	21/32	.19
839-248CSR	2x3/4	1-3/8	5/8	.19
839-249CSR	2x1	1-3/8	15/32	.20
839-420CSR	4x2	2-1/8	1-1/8	.91

CAP

Socket

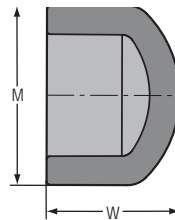

Part Number	Size	M	W	Approx. Wt. (Lbs.)
847-002C	1/4	13/16	15/16	.01
847-003C	3/8	31/32	1-1/8	.02
847-005C	1/2	1-3/16	1-7/32	.03
847-007C	3/4	1-3/8	1-13/32	.05
847-010C	1	1-23/32	1-5/8	.08
847-012C	1-1/4	2-3/32	1-27/32	.13
847-015C	1-1/2	2-11/32	2	.17
847-020C	2	2-7/8	2-1/4	.37
847-025C	2-1/2	3-17/32	2-5/8	.50
847-030C	3	4-5/32	3-1/32	.93
847-040C	4	5-1/4	3-19/32	1.20
847-050CF	5	6-1/2	4-7/16	5.28
847-060C	6	7-1/2	4-7/8	3.30
847-080C	8	9-23/32	6-3/8	6.36
847-100CF	10	12-1/4	5-15/16	7.49
847-120CF	12	14-1/4	7-1/8	11.72
847-140CF	14	15-1/2	7-3/8	16.54
847-160CF	16	17-7/8	9	24.52
847-180CF	18	19-15/16	9-1/4	28.88
847-200CF	20	22	14-1/4	52.00
847-240CF	24	26-3/8	17-1/4	89.74



Schedule 80 CPVC Technical Information
Schedule 80 CPVC Fittings

CAP

Fipt

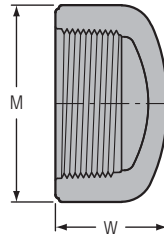

Part Number	Size	M	W	Approx. Wt. (Lbs.)
848-002C	1/4	29/32	15/16	.02
848-003C	3/8	31/32	29/32	.02
848-005C	1/2	1-3/16	1-1/16	.05
848-007C	3/4	1-3/32	1-7/32	.05
848-010C	1	1-27/32	1-7/16	.11
848-012C	1-1/4	2-7/32	1-17/32	.15
848-015C	1-1/2	2-17/32	1-5/8	.20
848-020C	2	3-5/32	1-25/32	.30
848-025C	2-1/2	3-5/8	2-7/16	.58
848-030C	3	4-3/8	2-7/16	.78
848-040C	4	5-7/16	3-1/16	1.45
848-060CF	6	7-3/16	4-3/8	6.18
848-080CF	8	9-3/8	4-3/8	10.07
848-100CF	10	11-5/8	5-3/4	7.69

SPECIAL REINFORCED CAP

SR Fipt

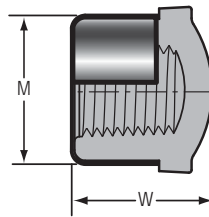

Part Number	Size	M	W	Approx. Wt. (Lbs.)
848-002CSR	1/4	27/32	27/32	.02
848-003CSR	3/8	31/32	29/32	.03
848-005CSR	1/2	1-3/16	1-1/8	.05
848-007CSR	3/4	1-3/8	1-3/32	.06
848-030CSR	3	4-9/32	2-7/16	.84

Schedule 80 CPVC Technical Information
Schedule 80 CPVC Fittings



PLUG

Spigot

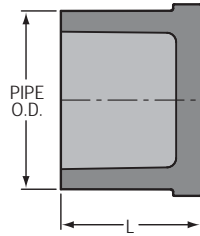

Part Number	Size	L	Approx. Wt. (Lbs.)
849-005C	1/2	1-1/8	.03
849-007C	3/4	1-1/4	.04
849-010C	1	1-3/8	.07
849-020C	2	1-7/8	.22
849-025CF	2-1/2	5-3/8	1.17
849-030CF	3	5-5/8	1.42
849-040CF	4	6-1/2	3.00
849-060CF	6	9	8.59
849-080CF	8	12	12
849-100CF	10	11-15/16	19.14
849-120CF	12	14-1/8	31.17



PLUG

Mipt

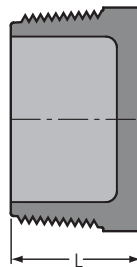

Part Number	Size	L	Approx. Wt. (Lbs.)
850-002C	1/4	23/32	.01
850-003C	3/8	13/16	.01
850-005C	1/2	13/16	.02
850-007C	3/4	7/8	.03
850-010C	1	1-1/4	.06
850-012C	1-1/4	1-9/32	.08
850-015C	1-1/2	1-11/32	.11
850-020C	2	1-3/8	.20
850-025C	2-1/2	1-25/32	.33
850-030C	3	1-7/8	.45
850-040C	4	2-3/32	.79
850-060C	6	2-3/32	1.80
850-080CF	8	8-5/8	12.39
850-100CF	10	8-7/16	13.76



Schedule 80 CPVC Technical Information
Schedule 80 CPVC Fittings

WYE

Socket x Socket x Socket

1/2" - 2" 235 psi @ 73°F
 2-1/2" - 6" 150 psi @ 73°F
 8" & Up & All Fab 100 psi @ 73°F

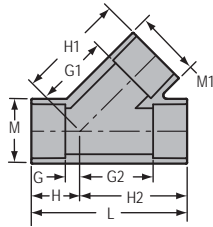

Part Number	Size	G	G1	G2	H	H1	H2	L	M	M1	Approx. Wt. (Lbs.)
875-005C	1/2	1/4	1-5/32	1-5/32	1-1/8	2-1/16	2-1/32	3-3/16	1-5/32	1-5/32	.13
875-007C	3/4	5/16	1-3/8	1-3/8	1-5/16	2-3/8	2-3/8	3-23/32	1-3/8	1-3/8	.20
875-010C	1	5/16	1-3/4	1-3/4	1-7/16	2-29/32	2-7/8	4-11/32	1-11/16	1-11/16	.33
875-012C	1-1/4	13/32	2-5/32	2-5/32	1-21/32	3-13/32	3-13/32	5-3/32	2-1/16	2-1/16	.53
875-015C	1-1/2	17/32	2-1/2	2-1/2	1-29/32	3-7/8	3-7/8	5-13/16	2-5/16	2-5/16	.74
875-020C	2	5/8	3-7/32	3-7/32	2-5/32	4-7/8	4-7/8	6-7/8	2-7/8	2-7/8	1.28
875-025C	2-1/2	27/32	3-31/32	3-31/32	2-19/32	5-23/32	5-23/32	8-5/16	3-1/2	3-1/2	2.08
875-030C	3	31/32	4-3/4	4-25/32	2-27/32	6-5/8	6-21/32	9-1/2	4-3/16	4-3/16	3.12
875-040C	4	1-1/4	6-1/32	6-1/32	3-1/2	8-9/32	8-9/32	11-25/32	5-1/4	5-1/4	5.31
875-060C	6	1-5/32	8-25/32	8-3/16	4-3/16	11-25/32	11-3/16	15-3/8	7-9/16	7-9/16	12.67
875-080C	8	1-15/16	11-11/32	11-11/32	5-31/32	15-11/32	15-11/32	21-5/16	9-3/4	9-3/4	26.97
875-080CF	8	5-1/16	15-7/8	13-11/16	9-5/16	20-1/8	17-15/16	27-1/4	9-5/8	9-5/8	44.67
875-100CF	10	6-1/2	18-7/8	17-1/4	11-3/4	24-1/8	22-1/2	34-1/4	11-15/16	11-15/16	75.04
875-120CF	12	7-1/8	21-13/16	19-7/8	13-3/8	28-1/16	26-1/8	39-1/2	14-1/8	14-1/8	123.20
875-140CF	14	9-13/16	23-13/16	23-13/16	16-13/16	30-13/16	30-13/16	47-5/8	15-1/2	15-1/2	149.48
875-160CF	16	10-1/8	26-1/8	26-1/8	18-1/8	34-1/8	34-1/8	52-1/4	17-11/16	17-11/16	211.73
875-180CF	18	10	29-3/8	28	19	38-3/8	37	56	19-7/8	19-7/8	292.04

REDUCING WYE

Socket x Socket x Socket

1/2" - 2-1/2" 235 psi @ 73°F
 3" - 6" 150 psi @ 73°F
 8" & Up & All Fab 100 psi @ 73°F

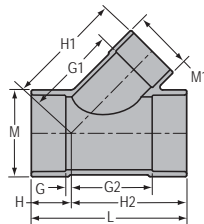

Part Number	Size	G	G1	G2	H	H1	H2	L	M	M1	Approx. Wt. (Lbs.)
875-167C ¹	1-1/4x1-1/4x3/4	3/8	2-3/4	2-1/4	1-5/8	3-3/4	3-1/2	5-1/8	2-1/16	2-1/16	.65
875-168C ¹	1-1/4x1-1/4x1	3/8	2-5/8	2-1/4	1-5/8	3-3/4	3-1/2	5-1/8	2-1/16	2-1/16	.62
875-210C ¹	1-1/2x1-1/2x3/4	1/2	3-1/2	2-9/16	1-7/8	4-1/2	3-15/16	5-13/16	2-11/32	2-11/32	.94
875-211C ¹	1-1/2x1-1/2x1	1/2	3	2-9/16	1-7/8	4-5/32	3-15/16	5-13/16	2-11/32	2-11/32	.89
875-212C ¹	1-1/2x1-1/2x1-1/4	1/2	3-1/4	2-9/16	1-7/8	4-1/2	3-15/16	5-13/16	2-11/32	2-11/32	.82
875-248C ¹	2x2x3/4	5/8	4-5/32	3-7/32	2-5/32	5-5/32	4-7/8	6-7/8	2-7/8	2-7/8	1.56

¹Outlet sized with bushing

Schedule 80 CPVC Technical Information
Schedule 80 CPVC Fittings



REDUCING WYE (continued)
 Socket x Socket x Socket

1/2" - 2-1/2" 235 psi @ 73°F
 3" - 6" 150 psi @ 73°F
 8" & Up & All Fab 100 psi @ 73°F

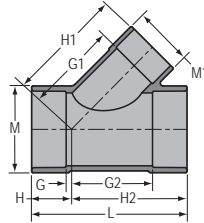

Part Number	Size	G	G1	G2	H	H1	H2	L	M	M1	Approx. Wt. (Lbs.)
875-250C ¹	2x2x1-1/4	5/8	3-5/16	3-3/8	2-5/32	5	4-3/4	6-7/8	2-7/8	2-7/8	1.52
875-251C ¹	2x2x1-1/2	1/2	3-23/32	3-11/32	2-1/32	5-3/32	4-7/8	6-7/8	2-7/8	2-7/8	1.44
875-335C ¹	3x3x1	11/16	5-7/8	4-7/32	2-9/16	6-15/16	6-1/8	8-23/32	4-3/16	4-3/16	3.57
875-336C ¹	3x3x1-1/4	7/8	5-3/4	4-1/8	2-3/4	7	6	8-3/4	4-3/16	4-3/16	3.34
875-337C ¹	3x3x1-1/2	2-5/8	5-1/2	4-1/4	2-5/8	6-7/8	6-1/8	8-3/4	4-3/16	4-3/16	3.21
875-338C ¹	3x3x2	1	5-11/32	4-3/4	2-7/8	6-31/32	6-5/8	9-1/2	4-3/16	4-3/16	3.21
875-339C ¹	3x3x2-1/2	7/8	4-1/8	4-21/32	2-3/4	6-3/4	6	8-3/4	4-3/16	4-3/16	3.11
875-420C	4x4x2	-7/8	5-5/32	4-11/16	1-3/8	6-11/16	6-15/16	8-5/16	5-9/32	2-29/32	2.92
875-422C	4x4x3	1/2	5-7/16	5-7/32	2-3/4	7-5/16	7-15/32	10-7/32	5-1/4	4-3/16	4.18
875-528C ¹	6x6x2	1/16	8-13/16	6-9/16	3-1/16	10-5/16	9-9/16	12-5/8	7-9/16	5-7/16	10.10
875-528CF	6x6x2	1-15/16	9-3/16	8-9/16	5-3/16	10-15/16	11-13/16	17	7-1/2	2-13/16	10.07
875-530C ¹	6x6x3	-1/16	8-3/8	6-11/16	3	10-1/4	9-11/16	12-5/8	7-9/16	5-3/8	9.82
875-530CF	6x6x3	2-15/16	10-5/16	9-9/16	6-3/16	12-9/16	12-13/16	19	7-1/2	4-1/8	12.14
875-532C	6x6x4	31/32	6-9/16	5-11/16	3-15/16	8-27/32	8-23/32	12-21/32	7-9/16	5-7/16	9.22
875-578C ¹	8x8x2	2	14-15/16	11-1/4	6	16-9/16	16-7/16	21-1/4	9-11/16	9-11/16	35.44
875-578CF	8x8x2	7/8	10-1/2	9-1/2	5-1/8	12-1/4	13-3/4	18-7/8	9-5/8	2-13/16	19.12
875-579CF	8x8x2-1/2	1-7/16	10-15/16	10-1/16	5-11/16	12-15/16	14-5/16	20	9-5/8	3-7/16	22.00
875-580CF	8x8x3	1-15/16	11-5/8	10-9/16	6-3/16	13-7/8	14-13/16	21	9-5/8	4-1/8	18.87
875-582C	8x8x4	11/16	9-1/8	8-1/4	3-5/16	11-3/8	12-1/4	15-9/16	9-3/4	5-1/4	15.32
875-582CF	8x8x4	2-15/16	11-7/8	11-9/16	7-3/16	14-1/8	15-13/16	23	9-5/8	5-3/16	27.78
875-585C ¹	8x8x6	2	12-15/16	11-1/4	6	15-15/16	15-1/4	21-1/4	9-11/16	9-11/16	32.29
875-585CF	8x8x6	4-15/16	13-15/16	13-9/16	9-3/16	17-3/16	17-13/16	27	9-5/8	7-1/2	34.75
875-621CF	10x10x2	1/4	11-7/8	10-1/2	5	13-5/8	15-3/4	20-3/4	11-15/16	2-13/16	26.48
875-623CF	10x10x3	3/4	13	11-1/2	6	15-1/4	16-3/4	22-3/4	11-15/16	4-1/8	29.62
875-624CF	10x10x4	1-3/4	13-1/4	12-1/2	7	15-1/2	17-3/4	24-3/4	11-15/16	5-3/16	39.21
875-626C	10x10x6	-3/16	12	11	4-13/16	15	16	20-25/32	12-1/16	7-21/32	29.85
875-626CF	10x10x6	3-3/4	15-5/16	14-1/2	9	18-9/16	19-3/4	28-3/4	11-15/16	7-1/2	29.74
875-628C	10x10x8	1-7/32	12-3/4	12-1/4	6-7/32	16-25/32	17-9/32	23-1/2	12-1/32	9-23/32	38.99
875-628CF	10x10x8	5-1/4	17-1/4	16	10-1/2	21-1/2	21-1/4	31-3/4	11-15/16	9-5/8	56.37
875-661CF	12x12x2	1-5/16	13-3/16	11-7/16	4-15/16	14-15/16	17-11/16	22-5/8	14-1/8	2-13/16	40.76
875-663CF	12x12x3	1/8	14-5/16	12-7/8	6-3/8	16-9/16	19-1/8	25-1/2	14-1/8	4-1/8	44.74
875-664CF	12x12x4	5/8	14-9/16	13-3/8	6-7/8	16-13/16	19-5/8	26-1/2	14-1/8	5-3/16	49.06
875-666CF	12x12x6	2-5/8	16-5/8	15-3/8	8-7/8	19-7/8	21-5/8	30-1/2	14-1/8	7-1/2	58.24
875-668CF	12x12x8	4-1/4	18-9/16	17	10-1/2	22-13/16	23-1/4	33-3/4	14-1/8	9-5/8	68.98
875-670CF	12x12x10	5-3/4	20-3/16	18-1/2	12	25-7/16	24-3/4	36-3/4	14-1/8	11-15/16	81.76
875-694CF	14x14x4	1-1/4	15-5/16	15-1/4	8-1/4	17-9/16	22-1/4	30-1/2	15-1/2	5-3/16	63.95
875-696CF	14x14x6	2	17-3/8	16	9	20-5/8	23	32	15-1/2	7-1/2	83.85

¹ Outlet sized with bushing





Schedule 80 CPVC Technical Information
Schedule 80 CPVC Fittings

REDUCING WYE

(continued)

Socket x Socket x Socket

1/2" - 2-1/2" 235 psi @ 73°F
 3" - 6" 150 psi @ 73°F
 8" & Up & All Fab 100 psi @ 73°F

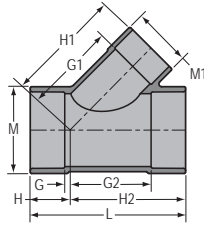

Part Number	Size	G	G1	G2	H	H1	H2	L	M	M1	Approx. Wt. (Lbs.)
875-698CF	14x14x8	4-1/4	19-5/16	18-1/4	11-1/4	23-9/16	25-1/4	36-1/2	15-1/2	9-5/8	82.78
875-700CF	14x14x10	5-3/4	20-15/16	19-3/4	12-3/4	26-3/16	26-3/4	39-1/2	15-1/2	11-15/16	107.47
875-702CF	14x14x12	7-1/4	22-9/16	21-1/4	14-1/4	28-13/16	28-1/4	42-1/2	15-1/2	14-1/8	115.64
875-754CF	16x16x4	1-1/8	16-5/8	17-1/8	9-1/8	18-7/8	25-1/8	34-1/4	17-11/16	5-3/16	88.48
875-756CF	16x16x6	1-5/8	18-11/16	17-5/8	9-5/8	21-15/16	25-5/8	35-1/4	17-11/16	7-1/2	94.93
875-758CF	16x16x8	3-5/8	20-5/8	19-5/8	11-5/8	24-7/8	27-5/8	39-1/4	17-11/16	9-5/8	108.85
875-760CF	16x16x10	5-1/8	22-1/4	21-1/8	13-1/8	27-1/2	29-1/8	42-1/4	17-11/16	11-15/16	137.97
875-762CF	16x16x12	6-1/2	23-7/8	22-1/2	14-1/2	30-1/8	30-1/2	45	17-11/16	14-1/8	146.49
875-764CF	16x16x14	7-7/8	25-1/8	23-7/8	15-7/8	32-1/8	31-7/8	47-3/4	17-11/16	15-1/2	167.10
875-784CF	18x18x4	0	17-7/8	18	9	20-1/8	27	36	19-7/8	5-3/16	119.05
875-786CF	18x18x6	3/8	20-1/8	18-9/16	9-3/8	23-3/8	27-9/16	36-15/16	19-7/8	7-1/2	131.59
875-788CF	18x18x8	3	21-7/8	21	12	26-1/8	30	42	19-7/8	9-5/8	146.16
875-790CF	18x18x10	4-1/2	23-1/2	22-1/2	13-1/2	28-3/4	31-1/2	45	19-7/8	11-15/16	163.18
875-792CF	18x18x12	6	25-1/8	24	15	31-3/8	33	48	19-7/8	14-1/8	184.28
875-794CF	18x18x14	7	26-3/8	25	16	33-3/8	34	50	19-7/8	15-1/2	211.65
875-796CF	18x18x16	8-1/2	27-3/8	26-1/2	17-1/2	35-3/8	35-1/2	53	19-7/8	17-11/16	243.00
875-822CF	20x20x12	5-5/8	26-7/16	25-5/8	15-5/8	32-11/16	35-5/8	51-1/4	22-1/16	14-1/8	213.90
875-824CF	20x20x14	7-1/8	27-11/16	27-1/8	17-1/8	34-11/16	37-1/8	54-1/4	22-1/16	15-1/2	239.07
875-826CF	20x20x16	8-1/2	28-11/16	28-1/2	18-1/2	36-11/16	38-1/2	57	22-1/16	17-11/16	321.08
875-904CF	24x24x4	3	21-3/4	21	9	24	33	42	26-7/16	5-3/16	251.85

¹ Outlet sized with bushing

DOUBLE WYE

Socket x Socket x Socket x Socket

100 psi @ 73°F

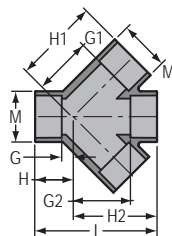

Part Number	Size	G	G1	G2	H	H1	H2	L	M	M1	Approx. Wt. (Lbs.)
876-020CF	2	3-7/8	6-1/4	6-1/4	5-7/16	7-13/16	7-13/16	13-3/16	2-7/8	2-7/8	3.01
876-030CF	3	4-3/4	8-1/8	8-1/4	6-5/8	10-3/16	10-3/16	16-13/16	4-3/16	4-3/16	5.84
876-040CF	4	4-11/16	9-3/16	9-3/16	6-15/16	11-7/16	11-7/16	18-3/8	5-3/16	5-3/16	13.33
876-060CF	6	4-15/16	12-5/8	11-9/16	8-3/16	15-7/8	14-13/16	23	7-1/2	7-1/2	28.16
876-080CF	8	5-1/16	15-7/8	13-11/16	9-5/16	20-1/8	17-15/16	27-1/4	9-5/8	9-5/8	55.13
876-100CF	10	6-1/2	18-7/8	17-1/4	11-3/4	24-1/8	22-1/2	34-1/4	11-15/16	11-15/16	94.00
876-120CF	12	7-1/8	21-13/16	19-7/8	13-3/8	28-1/16	26-1/8	39-1/2	14-1/8	14-1/8	149.15

Schedule 80 CPVC Technical Information
Schedule 80 CPVC Fittings



REDUCING DOUBLE WYE

Socket x Socket x Socket x Socket

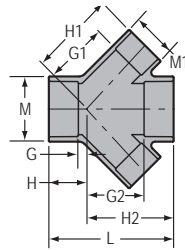

3" - 6" 150 psi @ 73°F
 All Fab 100 psi @ 73°F

Part Number	Size	G	G1	G2	H	H1	H2	L	M	M1	Approx. Wt. (Lbs.)
876-338C	3x2	3/8	4-1/4	4-13/32	2-1/4	5-3/4	5-29/32	8	4-3/16	2-7/8	2.24
876-421CF	4x2-1/2	4-9/16	8-13/16	9-1/16	6-13/16	10-1/2	11-5/16	18-1/8	5-1/4	3-1/2	6.00
876-422CF	4x3	4-11/16	10	9-3/16	6-15/16	11-13/16	11-7/16	18-3/8	5-3/16	5-3/16	14.00
876-528CF	6x2	1-15/16	9-3/16	8-9/16	5-3/16	10-15/16	11-13/16	17	7-1/2	2-13/16	11.45
876-529CF	6x2-1/2	2-7/16	9-5/8	9-1/16	5-11/16	11-5/8	12-5/16	18	7-1/2	3-7/16	14.00
876-530CF	6x3	2-15/16	10-15/16	9-9/16	6-3/16	12-9/16	12-13/16	19	7-1/2	4-1/8	12.14
876-532CF	6x4	3-15/16	10-9/16	10-9/16	7-3/16	12-13/16	13-13/16	21	7-1/2	5-3/16	19.78
876-578CF	8x2	7/8	10-1/2	9-1/2	5-1/8	12-1/4	13-3/4	18-7/8	9-5/8	2-13/16	19.56
876-579CF	8x2-1/2	1-7/16	10-15/16	10-1/16	5-11/16	12-15/16	14-5/16	20	9-5/8	3-7/16	22.00
876-580CF	8x3	1-15/16	11-5/8	10-9/16	6-3/16	13-7/8	14-13/16	21	9-5/8	4-1/8	21.92
876-582CF	8x4	2-15/16	11-7/8	11-9/16	7-3/16	14-1/8	15-13/16	23	9-5/8	5-3/16	24.78
876-585CF	8x6	4-15/16	13-15/16	13-9/16	9-3/16	17-3/16	17-13/16	27	9-5/8	7-1/2	41.48
876-621CF	10x2	1/4	11-7/8	10-1/2	5	13-5/8	15-3/4	20-3/4	11-15/16	2-13/16	26.98
876-622CF	10x2-1/2	1/8	12-5/16	10-7/8	5-3/8	14-5/16	16-1/8	21-1/2	11-15/16	3-7/16	32.27
876-623CF	10x3	3/4	13	11-1/2	6	15-1/4	16-3/4	22-3/4	11-15/16	4-1/8	29.62
876-624CF	10x4	1-3/4	13-1/4	12-1/2	7	15-1/2	17-3/4	24-3/4	11-15/16	5-3/16	34.22
876-626CF	10x6	3-3/4	15-5/16	14-1/2	9	18-9/16	19-3/4	28-3/4	11-15/16	7-1/2	46.55
876-628CF	10x8	5-1/4	17-1/4	16	10-1/2	21-1/2	21-1/4	31-3/4	11-15/16	9-5/8	60.66
876-661CF	12x2	1-5/16	13-3/16	11-7/16	4-15/16	14-15/16	17-11/16	22-5/8	14-1/8	2-13/16	40.76
876-662CF	12x2-1/2	15/16	13-5/8	11-13/16	5-5/16	15-5/8	18-1/16	23-3/8	14-1/8	3-7/16	55.95
876-663CF	12x3	1/8	14-5/16	12-7/8	6-3/8	16-9/16	19-1/8	25-1/2	14-1/8	4-1/8	44.74
876-664CF	12x4	5/8	14-9/16	13-3/8	6-7/8	16-13/16	19-5/8	26-1/2	14-1/8	5-3/16	49.06
876-666CF	12x6	2-5/8	16-5/8	15-3/8	8-7/8	19-7/8	21-5/8	30-1/2	14-1/8	7-1/2	58.24
876-668CF	12x8	4-1/4	18-9/16	17	10-1/2	22-13/16	23-1/4	33-3/4	14-1/8	9-5/8	86.23
876-670CF	12x10	5-3/4	20-3/16	18-1/2	12	25-7/16	24-3/4	36-3/4	14-1/8	11-15/16	100.26





Schedule 80 CPVC Technical Information
Schedule 80 CPVC Unions

UNION (Old Style)

Socket x Socket

Dimensions Also Applicable to
897-XXX EPDM O-ring Seal Units

235 psi @ 73°F

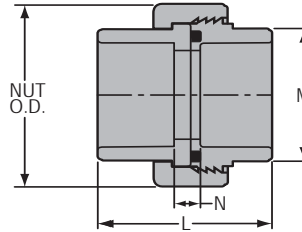

Part Number w/FKM O-ring Seal	Size	L	M	N	Nut O.D.	Approx. Wt. (Lbs.)
857-002C	1/4	1-15/16	15/16	5/8	1-21/32	.10
857-003C	3/8	2-5/32	1-1/32	19/32	1-25/32	.11
857-005C	1/2	2-3/32	1-9/32	11/32	1-31/32	.16
857-007C	3/4	2-3/8	1-17/32	11/32	2-1/2	.28
857-010C	1	2-9/16	1-27/32	3/8	2-7/8	.39
857-012C	1-1/4	2-7/8	2-7/32	3/8	3-5/16	.52
857-015C	1-1/2	3-3/32	2-9/16	15/32	3-9/16	.63
857-020C	2	3-5/8	3-1/32	9/16	4-3/16	1.05
857-025C	2-1/2	4-3/8	3-5/8	15/16	4-7/8	1.66
857-030C	3	5-1/16	4-3/8	1-3/16	5-3/4	2.51
857-040C	4	5-7/8	5-13/32	1-3/8	7-1/16	3.98

1) For (Socket X Socket) Unions Equipped With EPDM O-ring, Replace The 857 With An 897 Before The Dash.
 e.g. Part Number **897-002** = 1/4" PVC, Union, Socket x Socket, With **EPDM** O-rings.

UNION (Old Style)

Fipt x Fipt

Dimensions Also Applicable to
898-XXX EPDM O-ring Seal Units

235 psi @ 73°F

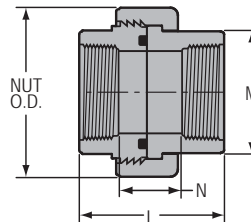

Part Number w/FKM O-ring Seal	Size	L	M	N	Nut O.D.	Approx. Wt. (Lbs.)
858-002C	1/4	1-15/16	15/16	11/16	1-21/32	.10
858-003C	3/8	2-5/32	1-1/32	15/16	1-25/32	.13
858-005C	1/2	2-3/32	1-9/32	19/32	1-31/32	.17
858-007C	3/4	2-3/8	1-17/32	3/4	2-1/2	.30
858-010C	1	2-9/16	1-27/32	7/16	2-7/8	.41
858-012C	1-1/4	2-7/8	2-7/32	7/8	3-5/16	.61
858-015C	1-1/2	3-3/32	2-9/16	1-5/32	3-9/16	.69
858-020C	2	3-5/8	3-1/32	1-11/16	4-3/16	1.13
858-025C	2-1/2	4-3/8	3-5/8	1-7/8	4-7/8	1.74
858-030C	3	5-1/16	4-3/8	1-13/16	5-3/4	2.70
858-040C	4	5-7/8	5-7/16	2-3/8	7-1/16	4.30

1) For (Fipt X Fipt) Unions Equipped With EPDM O-ring, Replace The 858 With An 898 Before The Dash.
 e.g. Part Number **898-002** = 1/4" PVC, Union, Fipt x Fipt, With **EPDM** O-rings.

Schedule 80 CPVC Technical Information
Schedule 80 CPVC Unions



UNION (Old Style)

Socket x Fipt

Dimensions Also Applicable to
899-XXX EPDM O-ring Seal Units

235 psi @ 73°F

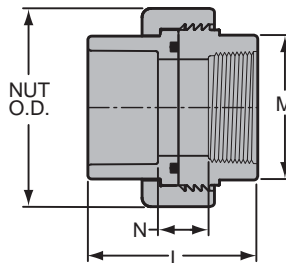

Part Number w/FKM O-ring Seal	Size	L	M	N	Nut O.D.	Approx. Wt. (Lbs.)
859-005C	1/2	2-3/32	1-9/32	15/32	1-31/32	.17
859-007C	3/4	2-3/8	1-17/32	9/16	2-1/2	.29
859-010C	1	2-9/16	1-27/32	13/32	2-7/8	.40
859-012C	1-1/4	2-7/8	2-7/32	5/8	3-5/16	.54
859-015C	1-1/2	3-1/8	2-19/32	27/32	3-9/16	.66
859-020C	2	3-5/8	3-1/32	1-1/16	4-3/16	1.10
859-025C	2-1/2	4-3/8	3-5/8	1-13/32	4-7/8	1.66
859-030C	3	5-1/16	4-3/8	1-1/2	5-3/4	2.61
859-040C	4	5-7/8	5-7/16	1-7/8	7-1/16	4.13

1) For (Socket X Fipt) Unions Equipped With EPDM O-ring, Replace The 859 With An 899 Before The Dash.
 e.g. Part Number **899-002** = 1/4" PVC, Union, Socket x Fipt, With **EPDM** O-rings.

TRANSITION UNION

Socket x Brass Fipt Threaded Insert and FKM O-ring Seal

Dimensions Also Applicable to **899-XXXBR EPDM O-ring Seal Units**

235 psi @ 73°F

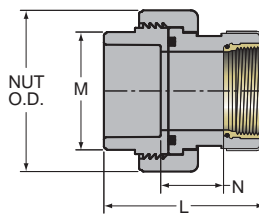

Part Number w/FKM O-ring Seal	Size	L	M	N	Nut O.D.	Approx. Wt. (Lbs.)
859-005CBR	1/2	2-1/4	1-9/32	3/4	1-31/32	.22
859-007CBR	3/4	2-11/16	1-17/32	15/16	2-1/2	.36
859-010CBR	1	2-13/16	1-7/8	1-1/32	2-7/8	.55
859-012CBR	1-1/4	3-9/32	2-7/32	1-1/16	3-5/16	.71
859-015CBR	1-1/2	3-1/2	2-9/16	1-3/32	3-17/32	.92
859-020CBR	2	3-5/8	2-7/8	1-1/4	4-5/16	1.64

Not intended to convey or dispense water for human consumption through drinking or cooking

1) For (Socket X Metal Fipt) Unions Equipped With EPDM O-ring, Replace The 859 With An 899 Before The Dash.
 e.g. Part Number **899-010BR** = 1" PVC, Union Socket x Metal Fipt With **EPDM** O-rings.



Schedule 80 CPVC Technical Information
Schedule 80 CPVC Unions

SPECIAL REINFORCED UNION (Old style)

Socket x SR Fipt

Dimensions Also Applicable to

899-XXXSR EPDM O-ring Seal Units

235 psi @ 73°F

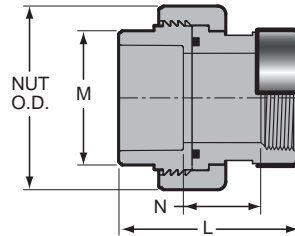

Part Number w/FKM O-ring Seal	Size	L	M	N	Nut O.D.	Approx. Wt. (Lbs.)
859-002CSR	1/4	2-1/16	15/16	25/32	1-21/32	.10
859-003CSR	3/8	2-9/32	1-1/32	29/32	1-25/32	.15
859-005CSR	1/2	2-9/32	1-9/32	21/32	1-31/32	.19
859-007CSR	3/4	2-19/32	1-17/32	25/32	2-1/2	.27
859-010CSR	1	2-15/16	1-27/32	25/32	2-7/8	.42
859-012CSR	1-1/4	3-5/32	2-7/32	29/32	3-5/16	.59
859-015CSR	1-1/2	3-13/32	2-9/16	1-1/32	3-9/16	.71
859-020CSR	2	4-3/32	3-1/32	1-19/32	4-3/16	1.21
859-030CSR	3	5-1/4	4-3/8	1-11/16	5-3/4	2.60
859-040CSR	4	5-7/8	5-13/32	2-1/8	7-3/32	4.21

1) For (Socket X SR Fipt) Unions Equipped With EPDM O-ring, Replace The 859 With An 899 Before The Dash.
 e.g. Part Number **899-002SR** = 1/4" PVC, Union, Socket x SR Fipt, With **EPDM** O-rings.

UNION 2000

Socket x Socket

Dimensions Also Applicable to

8097-XXX EPDM O-ring Seal Units

1/2" - 4" 235 psi @ 73°F
 6" 150 psi @ 73°F

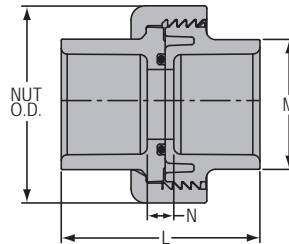

Part Number w/FKM O-ring Seal	Size	L	M	N	Nut O.D.	Approx. Wt. (Lbs.)
8057-005C	1/2	2-3/32	1-3/16	11/32	1-7/8	.08
8057-007C	3/4	2-3/8	1-13/32	3/8	2-9/32	.19
8057-010C	1	2-11/16	1-23/32	7/16	2-9/16	.17
8057-012C	1-1/4	2-15/16	2-3/32	7/16	3-3/32	.40
8057-015C	1-1/2	3-1/4	2-3/8	1/2	3-1/2	.51
8057-020C	2	3-17/32	2-7/8	17/32	4-9/32	.89
8057-025C	2-1/2	4-7/32	3-1/2	25/32	6-5/32	2.25
8057-030C	3	4-1/4	4-3/16	1/2	6-5/32	2.50
8057-040C	4	5-1/8	5-1/4	5/8	7-3/4	3.97
8057-060C	6	6-27/32	7-1/2	25/32	11-5/8	10.88

Schedule 80 CPVC Technical Information
Schedule 80 CPVC Unions



UNION 2000

Fipt x Fipt

Dimensions Also Applicable to
8098-XXX EPDM O-ring Seal Units

1/2" - 4" 235 psi @ 73°F
 6" 150 psi @ 73°F

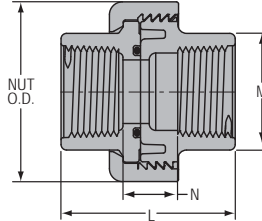

Part Number w/FKM O-ring Seal	Size	L	M	N	Nut O.D.	Approx. Wt. (Lbs.)
8058-005C	1/2	1-29/32	1-3/16	17/32	1-7/8	.08
8058-007C	3/4	2-1/16	1-3/8	9/16	2-9/32	.18
8058-010C	1	2-17/32	1-11/16	25/32	2-9/16	.11
8058-012C	1-1/4	2-21/32	2-1/32	3/4	3-1/8	.40
8058-015C	1-1/2	2-25/32	2-3/8	29/32	3-1/2	.50
8058-020C	2	3-1/8	3	1-3/16	4-7/32	.94
8058-025C	2-1/2	4-1/32	3-9/16	1-15/32	6-5/32	1.74
8058-030C	3	4-5/32	4-9/32	1-13/32	6-5/32	2.50
8058-040C	4	4-21/32	5-1/4	1-21/32	7-3/4	4.03
8058-060C	6	6-1/8	7-21/32	2-13/16	11-19/32	11.96



SPECIAL REINFORCED UNION 2000

SR Fipt x SR Fipt

Dimensions Also Applicable to
8098-XXXSR EPDM O-ring Seal Units

1/2" - 4" 235 psi @ 73°F
 6" 150 psi @ 73°F

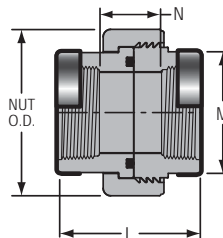

Part Number w/FKM O-ring Seal	Size	L	M	N	Nut O.D.	Approx. Wt. (Lbs.)
8058-005CSR	1/2	2	1-3/16	5/8	1-7/8	.14
8058-007CSR	3/4	2-5/32	1-3/8	21/32	2-9/32	.20
8058-010CSR	1	2-9/16	1-11/16	13/16	2-9/16	.24
8058-012CSR	1-1/4	2-23/32	2-1/32	13/16	3-1/8	.41
8058-015CSR	1-1/2	2-27/32	2-13/32	29/32	3-17/32	.56
8058-020CSR	2	3-7/32	3-1/32	1-3/16	4-7/32	1.02
8058-025CSR	2-1/2	4-3/32	3-9/16	1-15/32	6-5/32	1.73
8058-030CSR	3	4-3/16	4-9/32	1-3/8	6-5/32	2.50
8058-040CSR	4	4-11/16	5-1/4	1-11/16	7-3/4	4.17
8058-060CSR	6	6-3/16	7-11/16	2-13/16	11-5/8	11.54



Schedule 80 CPVC Technical Information
Schedule 80 CPVC Unions

UNION 2000

Socket x Fipt

Dimensions Also Applicable to
8099-XXX EPDM O-ring Seal Units

1/2" - 4" 235 psi @ 73°F
 6" 150 psi @ 73°F

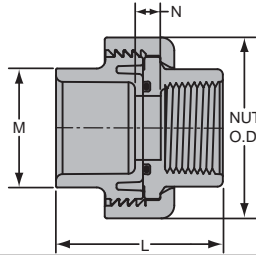

Part Number w/FKM O-ring Seal	Size	L	M	N	Nut O.D.	Approx. Wt. (Lbs.)
8059-005C	1/2	1-7/8	1-3/16	5/16	1-7/8	.08
8059-007C	3/4	2-1/16	1-13/32	5/16	2-9/32	.19
8059-010C	1	2-13/32	1-23/32	13/32	2-9/16	.09
8059-012C	1-1/4	2-19/32	2-3/32	13/32	3-1/8	.37
8059-015C	1-1/2	2-13/16	2-3/8	1/2	3-1/2	.50
8059-020C	2	2-31/32	2-7/8	13/32	4-9/32	.96
8059-025C	2-1/2	3-15/32	3-1/2	13/32	6-3/16	1.66
8059-030C	3	3-25/32	4-3/16	17/32	6-5/32	2.32
8059-040C	4	4-3/8	5-1/4	5/8	7-3/4	3.83
8059-060C	6	6-27/32	7-1/2	1-1/2	11-5/8	11.80

UNION 2000

Socket x SR Fipt

Dimensions Also Applicable to
8099-XXXSR EPDM O-ring Seal Units

1/2" - 4" 235 psi @ 73°F
 6" 150 psi @ 73°F

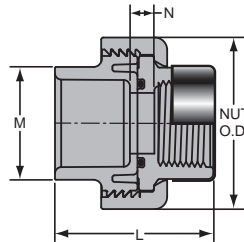

Part Number w/FKM O-ring Seal	Size	L	M	N	Nut O.D.	Approx. Wt. (Lbs.)
8059-005CSR	1/2	1-29/32	1-3/16	11/32	1-7/8	.09
8059-007CSR	3/4	2-5/32	1-13/32	13/32	2-9/32	.20
8059-010CSR	1	2-7/16	1-23/32	7/16	2-9/16	.20
8059-012CSR	1-1/4	2-5/8	2-3/32	7/16	3-1/8	.39
8059-015CSR	1-1/2	2-13/16	2-3/8	1/2	3-1/2	.56
8059-020CSR	2	3	2-7/8	7/16	4-7/32	1.04
8059-025CSR	2-1/2	3-27/32	3-15/32	27/32	6-3/16	2.29
8059-030CSR	3	3-3/4	4-3/16	1/2	6-9/32	2.38
8059-040CSR	4	4-3/8	5-1/4	5/8	7-3/4	2.95
8059-060CSR	6	6-27/32	7-1/2	2-5/32	11-5/8	11.95

Schedule 80 CPVC Technical Information
Schedule 80 CPVC Unions



UNION 2000

Socket x Spigot

Dimensions Also Applicable to

8096-XXX EPDM O-ring Seal Units

1/2" - 4" 235 psi @ 73°F
 6" 150 psi @ 73°F

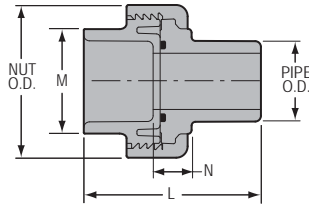

Part Number w/FKM O-ring Seal	Size	L	M	N	Nut O.D.	Approx. Wt. (Lbs.)
8056-005C	1/2	2-5/16	1-3/16	9/16	1-7/8	.13
8056-007C	3/4	2-5/8	1-3/8	21/32	2-9/32	.21
8056-010C	1	2-15/16	1-23/32	5/8	2-9/16	.30
8056-012C	1-1/4	3-7/32	2-3/32	11/16	3-3/16	.41
8056-015C	1-1/2	3-1/2	2-3/8	11/16	3-9/16	.54
8056-020C	2	3-3/4	2-7/8	3/4	4-5/16	.85
8056-025C	2-1/2	4-21/32	3-15/32	1-5/32	6-5/32	2.30
8056-030C	3	4-25/32	4-5/32	7/32	6-5/32	2.40
8056-040C	4	5-5/8	5-1/4	1-1/8	7-23/32	4.04
8056-060C	6	7-3/4	7-9/16	1-1/2	11-11/16	12.68





CLAMP-ON SADDLES

Simple Two-Piece Design Engineered for Reliability



Spears® CPVC Clamp-On Saddles allow quick, easy and reliable addition of branch lines to existing piping system lines. These versatile saddle units can be used in either temporary or permanent installations on all types of pipe with IPS (Iron Pipe size) outside diameter, such as PVC, CPVC, Polyethylene, Polypropylene and Steel.

Excellent Metal-to-Plastic System Transition

Easily installs on metal pipe as a transition to plastic system.

Tee or Cross Configurations

Available in 2" - 12" IPS pipe saddle with socket outlets in sizes 1/2" - 6" and Special Reinforced (SR) threaded outlets in sizes 1/2" - 6", single Tee or double Cross configurations.

Patented SR Design Female Threads

Patented Special Reinforced (SR) design on female thread outlets for superior strength.

O-ring Options

Choice of high grade Buna-N or EPDM O-rings for Schedule 40 and EPDM or FKM O-rings for Schedule 80, for application specific selection for optimum chemical resistance.

Multi-Bolt Design, Choice of Hardware

Positive attachment eliminates splitting problems associated with plastic wedge fasteners and outperforms 2-Bolt clamp saddle designs. Choose zinc plated or stainless steel nut, bolt and washer hardware.

Excellent Pressure Capabilities

Maximum internal pressure rating of 235 psi through 4", 200 psi for 6", and 150 psi for 8" - 12" at 73°F.

Sample Engineering Specification

All thermoplastic saddles shall be clamp-on type with O-ring seal constructed from CPVC Type IV cell classification 23447. All O-rings shall be Buna-N, EPDM or FKM. All saddles shall be piloted at O-ring area for positive positioning in pipe. All bolt clamping hardware shall be zinc plated steel or stainless steel. All threaded saddle outlets shall be Special Reinforced (SR) design. Saddles shall be pressure rated at 235 psi for use on pipe sizes through 4" nominal IPS diameters, 200 psi for use on 6" pipe, and 150 psi for use on 8" - 12" pipe, maximum internal pressure for water at 73°F, as manufactured by Spears® Manufacturing Company.



Clamp-On Saddle Installation Instructions

1. Using a standard industrial grade hole-saw, cut specified hole in desired position on pipe according to recommended hole saw size engraved on the saddle. **Note:** Care must be taken to deburr hole and remove all residue from hole area to assure tight fit and avoid leakage.
2. Fully seat O-ring in groove on underside of saddle outlet component. Position over hole and fully seat saddle onto pipe. Note: Certain saddle outlets are piloted. Be sure pilot lip fully engages with hole in pipe.
3. Place strap component opposite outlet and secure with bolts (4), nuts (4) and washers (8). Important: Washers **MUST** be placed under each bolt head (1) and under each nut (1) to avoid damage to saddle.
4. Tighten bolts to specified torque.

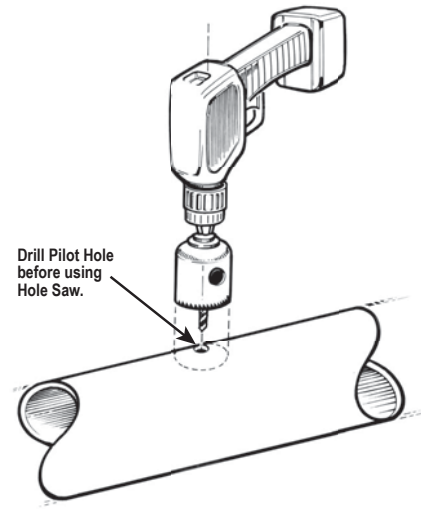

Saddle Size	2	3	4	6 & up
Recommended Bolt-Torque -ft/lb	8	8	8	10

O-ring seal provides positive, trouble-free sealing to pipe.

Special pilot engages with hole in pipe to prevent saddle dislocation.

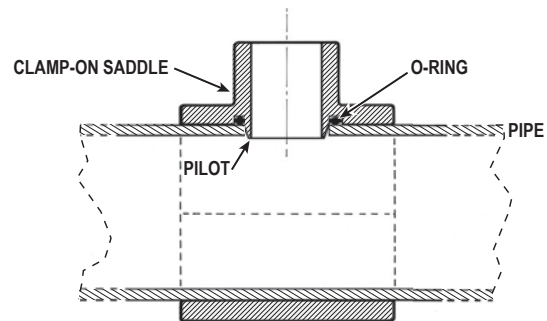
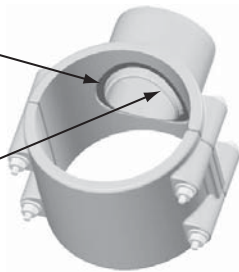

For Double Outlet Saddle Installation —Determine second outlet hole position as shown

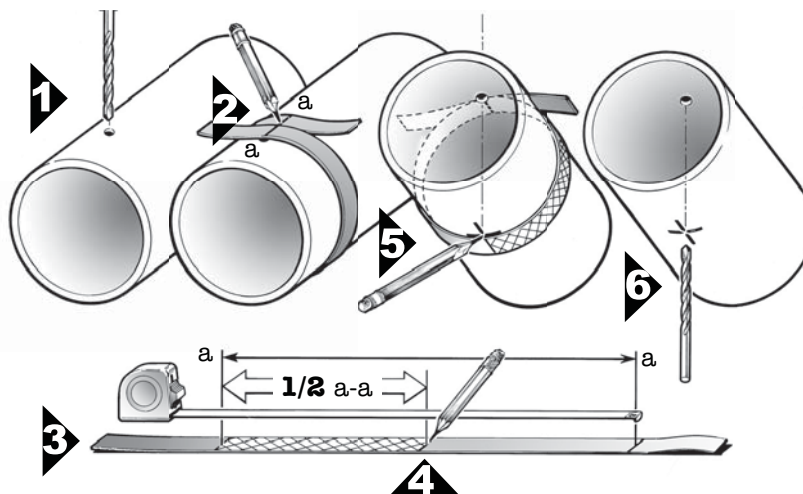



Schedule 80 CPVC Technical Information
Schedule 80 CPVC Saddles

**CLAMP ON SADDLE x SOCKET
 SINGLE OUTLET**

Dimensions Also Applicable to
 866S-XXX, 866V-XXX & 866SV-XXX

2" - 4" 235 psi @ 73°F
 6" 200 psi @ 73°F
 8" - 12" 150 psi @ 73°F

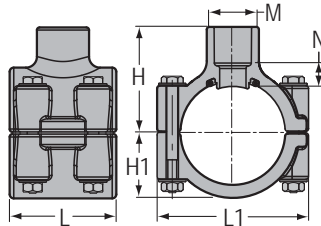

Part Number	Size	H	H1	L	L1	M	N	Hole Size	Bolt Torque ft./lbs.	Approx. Wt. (Lbs.)
866-247C	2x1/2	2-3/8	1-1/2	2-7/16	3-7/16	1-3/16	5/16	3/4	8	.59
866-248C	2x3/4	2-1/2	1-1/2	2-7/16	3-7/16	1-3/8	5/16	7/8	8	.60
866-249C	2x1	2-5/8	1-1/2	2-7/16	3-7/16	1-11/16	5/16	1-1/8	8	.62
866-250C	2x1-1/4	2-3/4	1-1/2	2-7/16	3-7/16	2-1/16	5/16	1-1/2	8	.64
866-251C	2x1-1/2	2-15/16	1-1/2	2-7/16	3-7/16	2-3/8	5/16	1-1/2	8	.70
866-291C	2-1/2x1-1/2	3-3/16	1-11/16	4-1/16	4	2-3/8	3/8	1-3/4	8	1.09
866-333C ¹	3x1/2	3-5/16	2-1/16	3	4-5/8	1-3/8	13/16	7/8	8	.92
866-334C	3x3/4	3-1/16	2-1/16	3	4-5/8	1-3/8	9/32	7/8	8	.89
866-335C	3x1	3-3/16	2-1/16	3	4-5/8	1-11/16	5/16	1-1/8	8	.91
866-336C ¹	3x1-1/4	4-1/32	2-1/16	4-3/32	4-5/8	3	1-1/32	2-1/4	8	1.56
866-337C ¹	3x1-1/2	4-1/32	2-1/16	4-3/32	4-5/8	3	29/32	2-1/4	8	1.52
866-338C	3x2	3-5/8	2-1/16	4-3/32	4-5/8	3	3/8	2-1/4	8	1.31
866-415C ¹	4x1/2	4-3/32	2-5/8	3	5-9/16	2-3/8	31/32	1-1/8	8	1.38
866-416C ¹	4x3/4	4-3/32	2-5/8	3	5-9/16	2-3/8	27/32	1-1/8	8	1.35
866-417C	4x1	3-13/16	2-5/8	3	5-5/8	1-11/16	7/16	1-1/8	8	1.31
866-418C ¹	4x1-1/4	4-13/32	2-5/8	4-3/32	5-5/8	2-3/8	29/32	1-3/4	8	1.80
866-419C	4x1-1/2	4-1/8	2-5/8	4-3/32	5-9/16	2-3/8	1/2	1-3/4	8	1.72
866-420C	4x2	4-3/16	2-5/8	4-1/8	5-5/8	3	7/16	2-1/4	8	1.79
866-421C ¹	4x2-1/2	5	2-5/8	5-7/16	5-23/32	4-9/32	3/4	3	8	2.95
866-422C	4x3	4-5/8	2-19/32	5-7/16	5-11/16	4-1/4	1/2	3	8	2.57
866-523C ¹	6x1/2	5-13/32	3-7/8	3	7-3/4	1-11/16	1-7/32	1-1/8	10	2.50
866-524C ¹	6x3/4	5-7/16	3-7/8	3	7-3/4	1-11/16	1-1/8	1-1/8	10	2.47
866-525C	6x1	5-1/8	3-7/8	3	7-15/16	1-11/16	11/16	1-1/8	10	2.43
866-526C ¹	6x1-1/4	5-15/16	3-7/8	4-1/8	7-3/4	3	1-3/8	2-1/4	10	3.48
866-527C ¹	6x1-1/2	5-15/16	3-7/8	4-1/8	7-3/4	3	1-1/4	2-1/4	10	3.43
866-528C	6x2	5-1/2	3-7/8	4-1/8	7-3/4	3	11/16	2-1/4	10	3.23
866-529C ¹	6x2-1/2	6-7/16	3-7/8	6	7-15/16	4-1/4	1-1/8	3	10	5.02
866-530C	6x3	5-15/16	3-7/8	6	7-15/16	4-1/4	25/32	3	10	4.61
866-532C	6x4	6	3-29/32	6	7-15/16	5-3/16	5/8	4	10	5.49

¹ Outlet sized with bushing



CLAMP ON SADDLE x SOCKET (continued)
SINGLE OUTLET

Dimensions Also Applicable to
 866S-XXX, 866V-XXX & 866SV-XXX

2" - 4" 235 psi @ 73°F
 6" 200 psi @ 73°F
 8" - 12" 150 psi @ 73°F

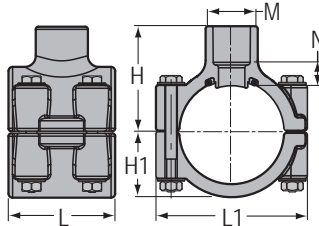

Part Number	Size	H	H1	L	L1	M	N	Hole Size	Bolt Torque ft./lbs.	Approx. Wt. (Lbs.)
866-573C ¹	8x1/2	7-3/4	4-7/8	9-1/2	8-1/2	5-5/16	1-1/2	4	10	10.09
866-574C ¹	8x3/4	8-3/32	4-7/8	8-1/2	10-1/8	5-1/4	2-3/4	4	10	10.07
866-575C ¹	8x1	8-3/32	4-7/8	8-1/2	10-1/8	5-1/4	2-5/8	4	10	10.07
866-576C ¹	8x1-1/4	8-3/32	4-7/8	8-1/2	10-1/8	5-1/4	2-1/2	4	10	10.23
866-577C ¹	8x1-1/2	8-3/32	4-7/8	8-1/2	10-1/8	5-1/4	2-3/8	4	10	10.44
866-578C ¹	8x2	7-11/16	4-7/8	8-1/2	10-1/8	5-1/4	1-7/8	4	10	10.50
866-579C ¹	8x2-1/2	8-5/32	4-7/8	8-15/32	10	5-7/32	2-1/2	4	10	10.02
866-580C ¹	8x3	7-11/16	4-7/8	8-1/2	10-1/8	5-1/4	1-7/16	4	10	10.61
866-582C	8x4	7-5/16	4-7/8	8-1/2	10-1/8	5-1/4	11/16	4	10	12.89
866-585C	8x6	8-3/32	4-7/8	8-1/2	10-1/8	7-5/8	11/16	6	10	9.30
866-621C ¹	10x2	8-7/8	6-1/32	8-1/2	12-5/16	5-1/4	1-15/16	4	10	13.56
866-624C	10x4	8-15/32	6-1/32	8-1/2	12-5/16	5-1/4	13/16	4	10	12.46
866-626C	10x6	9-9/32	6-1/32	8-1/2	12-5/16	7-5/8	13/16	6	10	13.50
866-664C	12x4	9-9/16	7-5/32	8-1/2	14-5/16	5-1/4	7/8	4	10	16.42
866-666C	12x6	10-3/8	7-5/32	8-1/2	14-5/16	7-5/8	7/8	6	10	17.20

¹ Outlet sized with bushing

- 1) Clamp On Saddle Standard Hardware: Zinc Bolts w/EPDM O-ring Seal
 e.g. Part Number 866-247 = 2x1/2 PVC Clamp On Saddle, Socket, EPDM O-ring, Zinc Bolts.
- 2) Clamp On Saddles w/Stainless Steel (SS) Bolts, Add The Letter "S" Before The Dash.
 e.g. Part Number 866S-247 = 2x1/2 PVC Clamp On Saddle, Socket, EPDM O-ring, Stainless Steel Bolts.
- 3) Clamp On Saddles w/FKM O-ring Seal, Add The Letter "V" Before The Dash.
 e.g. Part Number 866V-247 = 2x1/2 PVC Clamp-On Saddle, Socket, FKM O-ring, Zinc Bolts.
- 4) Clamp-On Saddles w/Stainless Steel Bolts & FKM O-ring Seal, Add The Letter "SV" Before The Dash.
 e.g. Part Number 866SV-247 = 2x1/2 PVC Clamp On Saddle, Socket FKM O-ring, Stainless Steel Bolts.





Schedule 80 CPVC Technical Information
Schedule 80 CPVC Saddles

**CLAMP ON SADDLE x SR FIPT
 SINGLE OUTLET**

Dimensions Also Applicable to
 867S-XXXSR, 867V-XXXSR & 867SV-XXXSR

2" - 4" 235 psi @ 73°F
 6" 200 psi @ 73°F
 8" - 12" 150 psi @ 73°F

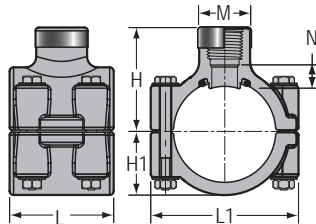

Part Number	Size	H	H1	L	L1	M	N	Hole Size	Bolt Torque ft./lbs.	Approx. Wt. (Lbs.)
867-247CSR	2x1/2	2-3/8	1-1/2	2-7/16	3-7/16	1-3/16	5/16	3/4	3/4	.59
867-248CSR	2x3/4	2-1/2	1-1/2	2-7/16	3-7/16	1-3/8	5/8	7/8	7/8	.60
867-249CSR	2x1	2-5/8	1-1/2	2-7/16	3-7/16	1-11/16	9/16	1-1/8	1-1/8	.62
867-250CSR	2x1-1/4	2-3/4	1-1/2	2-7/16	3-7/16	2-1/16	11/16	1-1/2	1-1/2	.64
867-251CSR	2x1-1/2	2-15/16	1-1/2	2-7/16	3-7/16	2-3/8	3/4	1-1/2	1-1/2	.70
867-291CSR	2-1/2x1-1/2	3-3/16	1-11/16	4-1/16	4	2-3/8	13/16	1-3/4	1-3/4	1.09
867-333CSR ¹	3x1/2	3-5/16	2-1/16	3	4-5/8	1-3/8	15/16	7/8	7/8	.93
867-334CSR	3x3/4	3-1/16	2-1/16	3	4-5/8	1-3/8	9/16	7/8	7/8	.91
867-335CSR	3x1	3-3/16	2-1/16	3	4-5/8	1-11/16	9/16	1-1/8	1-1/8	.93
867-336CSR ¹	3x1-1/4	4-1/32	2-1/16	4-3/32	4-5/8	3	1-5/16	2-1/4	2-1/4	1.61
867-337CSR ¹	3x1-1/2	4-1/32	2-1/16	4-3/32	4-5/8	3	2-11/16	2-1/4	2-1/4	1.56
867-338CSR	3x2	3-5/8	2-1/16	4-3/32	4-5/8	3	7/8	2-1/4	2-1/4	1.40
867-415CSR ¹	4x1/2	4-3/32	2-5/8	3	5-9/16	2-3/8	1-1/8	1-1/8	1-1/8	1.39
867-416CSR ¹	4x3/4	4-3/32	2-5/8	3	5-9/16	2-3/8	1-1/8	1-1/8	1-1/8	1.38
867-417CSR	4x1	3-13/16	2-5/8	3	5-5/8	1-11/16	11/16	1-1/8	1-1/8	1.33
867-418CSR ¹	4x1-1/4	4-13/32	2-5/8	4-3/32	5-5/8	2-3/8	1-7/32	1-3/4	1-3/4	1.85
867-419CSR ¹	4x1-1/2	4-1/8	2-5/8	4-3/32	5-9/16	2-3/8	15/16	1-3/4	1-3/4	1.78
867-420CSR	4x2	4-3/16	2-5/8	4-1/8	5-5/8	3	15/16	2-1/4	2-1/4	1.87
867-421CSR ¹	4x2-1/2	5	2-5/8	5-7/16	5-23/32	4-9/32	1-7/32	3	3	3.13
867-422CSR	4x3	4-5/8	2-19/32	5-7/16	5-11/16	4-1/4	31/32	3	3	2.69
867-523CSR ¹	6x1/2	5-13/32	3-7/8	3	7-3/4	1-11/16	1-3/8	1-1/8	1-1/8	2.50
867-524CSR ¹	6x3/4	5-7/16	3-7/8	3	7-3/4	1-11/16	1-3/8	1-1/8	1-1/8	2.50
867-525CSR	6x1	5-1/8	3-7/8	3	7-15/16	1-11/16	15/16	1-1/8	1-1/8	2.45
867-526CSR ¹	6x1-1/4	5-15/16	3-7/8	4-1/8	7-3/4	3	1-11/16	2-1/4	2-1/4	3.52
867-527CSR ¹	6x1-1/2	5-15/16	3-7/8	4-1/8	7-3/4	3	1-3/4	2-1/4	2-1/4	3.48
867-528CSR	6x2	5-1/2	3-7/8	4-1/8	7-3/4	3	1-7/32	2-1/4	2-1/4	3.32
867-529CSR ¹	6x2-1/2	6-7/16	3-7/8	6	7-15/16	4-1/4	1-9/16	3	3	5.17
867-530CSR	6x3	5-15/16	3-7/8	6	7-15/16	4-1/4	1-1/4	3	3	4.78
867-532CSR	6x4	6	3-29/32	6	7-15/16	5-3/16	1-3/8	4	4	5.78

Schedule 80 CPVC Technical Information
Schedule 80 CPVC Saddles



**CLAMP ON SADDLE x SR FIPT
 SINGLE OUTLET** (continued)

Dimensions Also Applicable to
 867**S**-XXXSR, 867**V**-XXXSR & 867**SV**-XXXSR

2" - 4" 235 psi @ 73°F
 6" 200 psi @ 73°F
 8" - 12" 150 psi @ 73°F

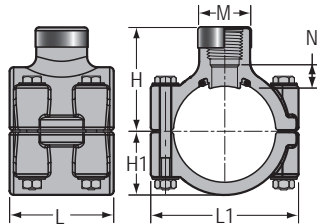

¹Outlet sized with bushing

Part Number	Size	H	H1	L	L1	M	N	Hole Size	Bolt Torque ft./lbs.	Approx. Wt. (Lbs.)
867-573CSR	8x1/2	8-3/32	4-7/8	8-1/2	10-1/8	5-1/4	3	4	10	10.07
867-574CSR ¹	8x3/4	8-3/32	4-7/8	8-1/2	10-1/8	5-1/4	3	4	10	10.25
867-575CSR	8x1	8-3/32	4-7/8	8-1/2	10-1/8	5-1/4	2-13/16	4	10	10.08
867-576CSR ¹	8x1-1/4	9-5/16	4-15/16	8-9/16	9-29/32	5-7/32	1-19/32	4	10	9.85
867-577CSR ¹	8x1-1/2	8-3/32	4-7/8	8-1/2	10-1/8	5-1/4	2-3/4	4	10	---
867-578CSR ¹	8x2	7-11/16	4-7/8	8-1/2	10-1/8	5-1/4	2-3/8	4	10	---
867-579CSR ¹	8x2-1/2	8-1/8	4-7/8	8-1/2	10-1/8	5-1/4	2-1/2	4	10	---
867-580CSR ¹	8x3	7-11/16	4-7/8	8-1/2	10-1/8	5-1/4	1-15/16	4	10	---
867-582CSR	8x4	7-5/16	4-7/8	8-1/2	10-1/8	5-1/4	1-1/2	4	10	8.09
867-585CSR	8x6	8-3/32	4-7/8	8-1/2	10-1/8	7-5/8	2-3/32	6	10	9.08
867-624CSR	10x4	8-15/32	6-1/32	8-1/2	12-5/16	5-1/4	2-3/16	4	10	---
867-626CSR	10x6	9-9/32	6-1/32	8-1/2	12-5/16	7-5/8	3-3/16	6	10	---
867-664CSR	12x4	9-9/16	7-5/32	8-1/2	14-5/16	5-1/4	1-5/8	4	10	---
867-666CSR	12x6	10-3/8	7-5/32	8-1/2	14-5/16	7-5/8	2-1/4	6	10	---

¹Outlet sized with bushing

- 1) Clamp On Saddle Standard Hardware: Zinc Bolts w/EPDM O-ring Seal
 e.g. Part Number 867-247SR = 2x1/2 PVC Clamp On Saddle, SR Threaded, EPDM O-ring, Zinc Bolts.
- 2) Clamp On Saddles w/Stainless Steel (SS) Bolts, Add The Letter "**S**" Before The Dash.
 e.g. Part Number 867**S**-247SR = 2x1/2 PVC Clamp On Saddle, SR Threaded, EPDM O-ring, Stainless Steel Bolts.
- 3) Clamp On Saddles w/FKM O-ring Seal, Add The Letter "**V**" Before The Dash.
 e.g. Part Number 867**V**-247SR = 2x1/2 PVC Clamp-On Saddle, SR Threaded, FKM O-ring, Zinc Bolts.
- 4) Clamp-On Saddles w/Stainless Steel Bolts & FKM O-ring Seal, Add The Letter "**SV**" Before The Dash.
 e.g. Part Number 867**SV**-247SR = 2x1/2 PVC Clamp On Saddle, SR Threaded FKM O-ring, Stainless Steel Bolts.





Schedule 80 CPVC Technical Information
Schedule 80 CPVC Saddles

**CLAMP ON SADDLE x SOCKET
 DOUBLE OUTLET**

Dimensions Also Applicable to
 868S-XXX, 868V-XXX & 868SV-XXX

2" - 4" 235 psi @ 73°F
 6" 200 psi @ 73°F
 8" - 12" 150 psi @ 73°F

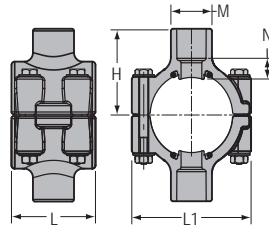

Part Number	Size	H	L	L1	M	N	Hole Size	Bolt Torque ft./lbs.	Approx. Wt. (Lbs.)
868-247C	2x1/2	2-3/8	2-7/16	3-7/16	1-3/16	5/16	3/4	8	.59
868-248C	2x3/4	2-1/2	2-7/16	3-7/16	1-3/8	5/16	7/8	8	.60
868-249C	2x1	2-5/8	2-7/16	3-7/16	1-11/16	5/16	1-1/8	8	.62
838-250C	2x1-1/4	2-3/4	2-7/16	3-7/16	2-1/16	5/16	1-1/2	8	.64
868-251C	2x1-1/2	2-15/16	2-7/16	3-7/16	2-3/8	5/16	1-1/2	8	.70
868-291C	2-1/2x1-1/2	3-3/16	4-1/16	4	2-3/8	3/8	1-3/4	8	1.09
868-333C ¹	3x1/2	3-5/16	3	4-5/8	1-3/8	13/16	7/8	8	.97
868-334C	3x3/4	3-1/16	3	4-5/8	1-3/8	9/32	7/8	8	.92
868-335C	3x1	3-3/16	3	4-5/8	1-11/16	5/16	1-1/8	8	.96
868-336C ¹	3x1-1/4	4-1/32	4-3/32	4-5/8	3	1-1/32	2-1/4	8	2.06
868-337C ¹	3x1-1/2	4-1/32	4-3/32	4-5/8	3	29/32	2-1/4	8	1.97
868-338C	3x2	3-5/8	4-3/32	4-5/8	3	3/8	2-1/4	8	1.57
868-415C ¹	4x1/2	4-3/32	3	5-9/16	2-3/8	31/32	1-1/8	8	1.51
868-416C ¹	4x3/4	4-3/32	3	5-9/16	2-3/8	27/32	1-1/8	8	1.46
868-417C	4x1	3-13/16	3	5-5/8	1-11/16	7/16	1-1/8	8	1.37
868-418C ¹	4x1-1/4	4-13/32	4-3/32	5-5/8	2-3/8	29/32	1-3/4	8	2.04
868-419C	4x1-1/2	4-1/8	4-3/32	5-9/16	2-3/8	1/2	1-3/4	8	1.87
868-420C	4x2	4-3/16	4-1/8	5-5/8	3	7/16	2-1/4	8	2.01
868-421C ¹	4x2-1/2	5	5-7/16	5-23/32	4-9/32	3/4	3	8	3.98
868-422C	4x3	4-5/8	5-7/16	5-11/16	4-1/4	1/2	3	8	3.16
868-523C ¹	6x1/2	5-13/32	3	7-3/4	1-11/16	1-7/32	1-1/8	10	2.63
868-524C ¹	6x3/4	5-7/16	3	7-3/4	1-11/16	1-1/8	1-1/8	10	2.58
868-525C	6x1	5-1/8	3	7-15/16	1-11/16	11/16	1-1/8	10	2.49
868-526C ¹	6x1-1/4	5-15/16	4-1/8	7-3/4	3	1-3/8	2-1/4	10	3.93
868-527C ¹	6x1-1/2	5-15/16	4-1/8	7-3/4	3	1-1/4	2-1/4	10	3.84
868-528C	6x2	5-1/2	4-1/8	7-3/4	3	11/16	2-1/4	10	3.44
868-529C ¹	6x2-1/2	6-7/16	6	7-15/16	4-1/4	1-1/8	3	10	5.93
868-530C	6x3	5-15/16	6	7-15/16	4-1/4	25/32	3	10	5.11
868-532C	6x4	6	6	7-15/16	5-3/16	5/8	4	10	6.10
868-573C ¹	8x1/2	8-3/32	8-1/2	10-1/8	5-1/4	2-3/16	4	10	12.06

¹Outlet sized with bushing

Schedule 80 CPVC Technical Information
Schedule 80 CPVC Saddles



CLAMP ON SADDLE x SOCKET (continued)
DOUBLE OUTLET

Dimensions Also Applicable to
 868**S**-XXX, 868**V**-XXX & 868**SV**-XXX

2" - 4" 235 psi @ 73°F
 6" 200 psi @ 73°F
 8" - 12" 150 psi @ 73°F

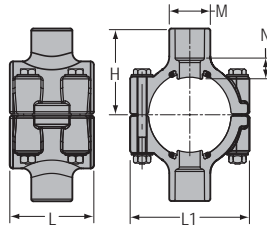

Part Number	Size	H	L	L1	M	N	Hole Size	Bolt Torque ft./lbs.	Approx. Wt. (Lbs.)
868-574C ¹	8x3/4	8-3/32	8-1/2	10-1/8	5-1/4	2-3/4	4	10	12.01
868-575C ¹	8x1	8-3/32	8-1/2	10-1/8	5-1/4	2-5/8	4	10	12.02
868-576C ¹	8x1-1/4	8-3/32	8-1/2	10-1/8	5-1/4	2-1/2	4	10	11.88
868-577C ¹	8x1-1/2	8-3/32	8-1/2	10-1/8	5-1/4	2-3/8	4	10	11.78
868-578C ¹	8x2	7-11/16	8-1/2	10-1/8	5-1/4	1-7/8	4	10	11.47
868-579C ¹	8x2-1/2	8-1/8	8-1/2	10-1/8	5-1/4	1-11/16	4	10	9.21
868-580C ¹	8x3	7-11/16	8-1/2	9-7/8	5-7/32	2-1/16	4	10	10.92
868-582C	8x4	7-5/16	8-1/2	10-1/8	5-1/4	11/16	4	10	8.62
868-585C	8x6	8-3/32	8-1/2	10-1/8	7-5/8	11/16	6	10	10.81
868-624C	10x4	8-15/32	8-1/2	12-5/16	5-1/4	13/16	4	10	12.99
868-626C	10x6	9-9/32	8-1/2	12-5/16	7-5/8	13/16	6	10	15.15
868-664C	12x4	9-9/16	8-1/2	14-5/16	5-1/4	7/8	4	10	17.06
868-666C	12x6	10-3/8	8-1/2	14-5/16	7-5/8	7/8	6	10	18.64

¹ Outlet sized with bushing

- 1) Clamp On Saddle Standard Hardware: Zinc Bolts w/EPDM O-ring Seal
 e.g. Part Number 868-247 = 2x1/2 PVC Clamp On Saddle, Socket, EPDM O-ring, Zinc Bolts.
- 2) Clamp On Saddles w/Stainless Steel (SS) Bolts, Add The Letter **"S"** Before The Dash.
 e.g. Part Number 868**S**-247 = 2x1/2 PVC Clamp On Saddle, Socket, EPDM O-ring, Stainless Steel Bolts.
- 3) Clamp On Saddles w/FKM O-ring Seal, Add The Letter **"V"** Before The Dash.
 e.g. Part Number 868**V**-247 = 2x1/2 PVC Clamp-On Saddle, Socket, FKM O-ring, Zinc Bolts.
- 4) Clamp-On Saddles w/Stainless Steel Bolts & FKM O-ring Seal, Add The Letter **"SV"** Before The Dash.
 e.g. Part Number 868**SV**-247 = 2x1/2 PVC Clamp On Saddle, Socket FKM O-ring, Stainless Steel Bolts.





Schedule 80 CPVC Technical Information
Schedule 80 CPVC Saddles

**CLAMP ON SADDLE x SR FIPT
 DOUBLE OUTLET**

Dimensions Also Applicable to
 869S-XXXSR, 869V-XXXSR & 869SV-XXXSR

2" - 4" 235 psi @ 73°F
 6" 200 psi @ 73°F
 8" - 12" 150 psi @ 73°F

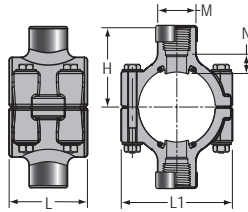

Part Number	Size	H	L	L1	M	N	Hole Size	Bolt Torque ft./lbs.	Approx. Wt. (Lbs.)
869-247CSR	2x1/2	2-3/8	2-7/16	3-7/16	1-3/16	5/16	3/4	8	.59
869-248CSR	2x3/4	2-1/2	2-7/16	3-7/16	1-3/8	5/8	7/8	8	.60
869-249CSR	2x1	2-5/8	2-7/16	3-7/16	1-11/16	9/16	1-1/8	8	.62
869-250CSR	2x1-1/4	2-3/4	2-7/16	3-7/16	2-1/16	11/16	1-1/2	8	.64
869-251CSR	2x1-1/2	2-15/16	2-7/16	3-7/16	2-3/8	3/4	1-1/2	8	.70
869-291CSR	2-1/2x1-1/2	3-3/16	4-1/16	4	2-3/8	13/16	1-3/4	8	1.09
869-333CSR ¹	3x1/2	3-5/16	3	4-5/8	1-3/8	15/16	7/8	8	1.00
869-334CSR	3x3/4	3-1/16	3	4-5/8	1-3/8	9/16	7/8	8	.96
869-335CSR	3x1	3-3/16	3	4-5/8	1-11/16	9/16	1-1/8	8	1.00
869-336CSR ¹	3x1-1/4	4-1/32	4-3/32	4-5/8	3	1-5/16	2-1/4	8	2.15
869-337CSR ¹	3x1-1/2	4-1/32	4-3/32	4-5/8	3	2-11/16	2-1/4	8	2.06
869-338CSR	3x2	3-5/8	4-3/32	4-5/8	3	7/8	2-1/4	8	1.74
869-415CSR ¹	4x1/2	4-3/32	3	5-9/16	2-3/8	1-1/8	1-1/8	8	1.53
869-416CSR ¹	4x3/4	4-3/32	3	5-9/16	2-3/8	1-1/8	1-1/8	8	1.52
869-417CSR	4x1	3-13/16	3	5-5/8	1-11/16	11/16	1-1/8	8	1.41
869-418CSR ¹	4x1-1/4	4-13/32	4-3/32	5-5/8	2-3/8	1-7/32	1-3/4	8	2.13
869-419CSR	4x1-1/2	4-1/8	4-3/32	5-9/16	2-3/8	15/16	1-3/4	8	1.99
869-420CSR	4x2	4-3/16	4-1/8	5-5/8	3	15/16	2-1/4	8	2.18
869-421CSR ¹	4x2-1/2	5	5-7/16	5-23/32	4-9/32	1-7/32	3	8	4.29
869-422CSR	4x3	4-5/8	5-7/16	5-11/16	4-1/4	31/32	3	8	3.39
869-523CSR ¹	6x1/2	5-13/32	3	7-3/4	1-11/16	1-3/8	1-1/8	10	2.64
869-524CSR ¹	6x3/4	5-7/16	3	7-3/4	1-11/16	1-3/8	1-1/8	10	2.63
869-525CSR	6x1	5-1/8	3	7-15/16	1-11/16	15/16	1-1/8	10	2.53
869-526CSR ¹	6x1-1/4	5-15/16	4-1/8	7-3/4	3	1-11/16	2-1/4	10	4.03
869-527CSR ¹	6x1-1/2	5-15/16	4-1/8	7-3/4	3	1-3/4	2-1/4	10	3.93
869-528CSR	6x2	5-1/2	4-1/8	7-3/4	3	1-7/32	2-1/4	10	3.62
869-529CSR ¹	6x2-1/2	6-7/16	6	7-15/16	4-1/4	1-9/16	3	10	6.23
869-530CSR	6x3	5-15/16	6	7-15/16	4-1/4	1-1/4	3	10	5.45
869-532CSR	6x4	6	6	7-15/16	5-3/16	1-3/8	4	10	6.67
869-573CSR ¹	8x1/2	8-3/32	8-1/2	10-1/8	5-1/4	3	4	10	12.02

¹Outlet sized with bushing

Schedule 80 CPVC Technical Information
Schedule 80 CPVC Saddles



**CLAMP ON SADDLE x SR FIPT
 DOUBLE OUTLET** (continued)

Dimensions Also Applicable to
 869**S**-XXXSR, 869**V**-XXXSR & 869**SV**-XXXSR

2" - 4" 235 psi @ 73°F
 6" 200 psi @ 73°F
 8" - 12" 150 psi @ 73°F

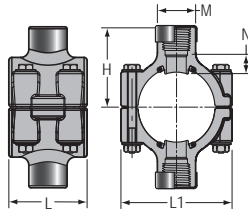

Part Number	Size	H	L	L1	M	N	Hole Size	Bolt Torque ft./lbs.	Approx. Wt. (Lbs.)
869-574CSR ¹	8x3/4	8-3/32	8-1/2	10-1/8	5-1/4	3	4	10	---
869-575CSR ¹	8x1	8-3/32	8-1/2	10-1/8	5-1/4	2-13/16	4	10	---
869-576CSR ¹	8x1-1/4	8-3/32	8-1/2	10-1/8	5-1/4	2-3/4	4	10	---
869-577CSR ¹	8x1-1/2	8-3/32	8-1/2	10-1/8	5-1/4	2-3/4	4	10	---
869-578CSR ¹	8x2	7-11/16	8-1/2	10-1/8	5-1/4	2-3/8	4	10	---
869-579CSR ¹	8x2-1/2	8-1/8	8-1/2	10-1/8	5-1/4	2-1/2	4	10	---
869-580CSR ¹	8x3	7-11/16	8-1/2	10-1/8	5-1/4	1-15/16	4	10	---
869-582CSR	8x4	7-5/16	8-1/2	10-1/8	5-1/4	1-1/2	4	10	9.29
869-585CSR	8x6	8-3/32	8-1/2	10-1/8	7-5/8	2-3/32	6	10	10.81
869-624CSR	10x4	8-15/32	8-1/2	12-5/16	5-1/4	2-3/16	4	10	---
869-626CSR	10x6	9-9/32	8-1/2	12-5/16	7-5/8	3-3/16	6	10	---
869-664CSR	12x4	9-9/16	8-1/2	14-5/16	5-1/4	1-5/8	4	10	---
869-666CSR	12x6	10-3/8	8-1/2	14-5/16	7-5/8	2-1/4	6	10	---

¹Outlet sized with bushing

- 1) Clamp On Saddle Standard Hardware: Zinc Bolts w/EPDM O-ring Seal
 e.g. Part Number 869-247SR = 2x1/2 PVC Clamp On Saddle, SR Threaded, EPDM O-ring, Zinc Bolts.
- 2) Clamp On Saddles w/Stainless Steel (SS) Bolts, Add The Letter "S" Before The Dash.
 e.g. Part Number 869**S**-247SR = 2x1/2 PVC Clamp On Saddle, SR Threaded, EPDM O-ring, Stainless Steel Bolts.
- 3) Clamp On Saddles w/FKM O-ring Seal, Add The Letter "V" Before The Dash.
 e.g. Part Number 869**V**-247SR = 2x1/2 PVC Clamp-On Saddle, SR Threaded, FKM O-ring, Zinc Bolts.
- 4) Clamp-On Saddles w/Stainless Steel Bolts & FKM O-ring Seal, Add The Letter "SV" Before The Dash.
 e.g. Part Number 869**SV**-247SR = 2x1/2 PVC Clamp On Saddle, SR Threaded FKM O-ring, Stainless Steel Bolts.





Schedule 80 CPVC Technical Information
Schedule 80 CPVC Tank Adapters

NEW STYLE - TANK ADAPTER

Socket x Socket

Dimensions Also Applicable to 8170E-XXX & 8170V-XXX

150 psi @ 73°F

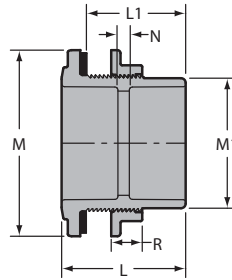

Part Number	Size	L	L1	M	M1	N	R	Approx. Wt. (Lbs.)
8170-002C	1/4	2-1/2	1-13/16	1-1/2	1-1/16	1-3/16	1/2	.11
8170-003C	3/8	2-1/2	1-27/32	1-5/8	31/32	7/8	1/2	.12
8170-005C	1/2	2-15/16	2-3/16	2-1/16	1-3/16	1-1/8	5/8	.23
8170-007C	3/4	2-15/16	2-3/16	2-1/4	1-5/8	15/16	5/8	.27
8170-010C	1	3-5/16	2-9/16	2-5/8	2	1-1/16	5/8	.41
8170-012C	1-1/4	3-7/16	2-5/8	3-1/8	2-5/16	15/16	5/8	.45
8170-015C	1-1/2	3-5/8	2-13/16	3-5/8	2-11/16	13/16	5/8	1.04
8170-020C	2	4-1/8	3-1/4	4-7/8	3-1/4	1-1/16	3/4	1.33
8170-025C	2-1/2	4-27/32	3-7/8	5-1/4	3-9/16	29/32	1	2.60
8170-030C	3	5-1/2	4-1/2	6	4-9/16	1-11/16	1	2.69
8170-040C	4	5	4	7-1/2	5-1/2	7/16	1-1/4	3.40
8170-080C	8	8-5/8	7	12-15/16	10-1/4	1/2	1-1/2	17.30

Tank Adapter Referenced Dimension Tolerance = ± 1/16"

NEW STYLE - TANK ADAPTER

Socket x Fipt

Dimensions Also Applicable to 8171E-XXX & 8171V-XXX

150 psi @ 73°F

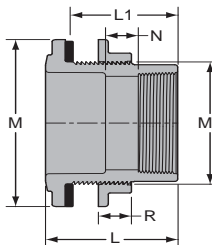

Part Number	Size	L	L1	M	M1	N	R	Approx. Wt. (Lbs.)
8171-002C	1/4	2-1/2	1-13/16	1-1/2	1-1/16	1-1/4	1/2	.11
8171-003C	3/8	2-1/2	1-13/16	1-5/8	1-3/16	1-3/16	1/2	.12
8171-005C	1/2	2-15/16	2-3/16	2-1/16	1-3/16	1-1/4	5/8	.23
8171-007C	3/4	2-15/16	2-15/32	2-1/4	1-5/8	1-3/16	5/8	.26
8171-010C	1	3-5/16	2-13/16	2-5/8	1-31/32	1-1/4	5/8	.38
8171-012C	1-1/4	3-13/32	2-27/32	3-3/32	2-5/16	1-17/32	5/8	.53
8171-015C	1-1/2	3-5/8	2-13/16	3-5/8	2-11/16	1-1/4	5/8	.71
8171-020C	2	4-1/8	3-1/4	4-7/8	3-1/4	1-5/8	3/4	1.34

Schedule 80 CPVC Technical Information
Schedule 80 CPVC Tank Adapters



NEW STYLE - TANK ADAPTER (continued)

Socket x Fipt

Dimensions Also Applicable to 8171E-XXX & 8171V-XXX

150 psi @ 73°F

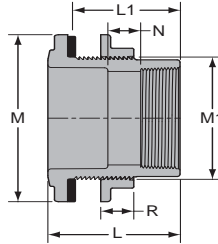

Part Number	Size	L	L1	M	M1	N	R	Approx. Wt. (Lbs.)
8171-025C	2-1/2	4-7/8	7/8	5-1/4	3-13/16	1-13/16	1	1.92
8171-030C	3	5-1/2	4-1/2	6	4-9/16	2-3/16	1	2.80
8171-040C	4	5	4	7-1/2	5-1/2	1-1/4	1-1/4	3.36
8171-060C	6	4-31/32	4-1/16	10-1/16	7-11/16	1/16	1-1/4	5.92

NEW STYLE - TANK ADAPTER

Socket x SR Fipt

Dimensions Also Applicable to 8171E-XXXSR & 8171V-XXXSR

150 psi @ 73°F

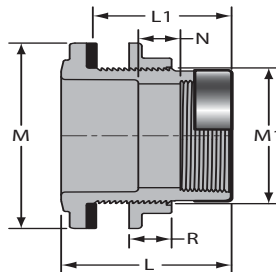

Part Number	Size	L	L1	M	M1	N	R	Approx. Wt. (Lbs.)
8171-002CSR	1/4	2-1/2	1-13/16	1-1/2	1-1/16	1-1/4	1/2	.11
8171-003CSR	3/8	2-1/2	1-13/16	1-5/8	1-3/16	1-3/16	1/2	.13
8171-005CSR	1/2	2-15/16	2-1/4	2-1/16	1-7/32	1-9/32	5/8	.24
8171-007CSR	3/4	2-15/16	2-3/16	2-1/4	1-5/8	1-1/4	5/8	.28
8171-010CSR	1	3-5/16	2-13/16	2-5/8	1-31/32	1-1/4	5/8	.38
8171-012CSR	1-1/4	3-13/32	2-5/8	3-3/32	2-5/16	1-17/32	5/8	.53
8171-015CSR	1-1/2	3-5/8	2-13/16	3-5/8	2-11/16	1-1/4	5/8	.74
8171-020CSR	2	4-1/8	3-1/4	4-7/8	3-1/4	1-5/8	3/4	1.70
8171-025CSR	2-1/2	4-7/8	3-7/8	5-1/4	3-13/16	1-11/16	1	1.99
8171-030CSR	3	5-1/2	4-1/2	6	4-9/16	2-3/16	1	2.82
8171-040CSR	4	5	4	7-1/2	5-1/2	1-1/4	1-1/4	4.45
8171-060CSR	6	4-31/32	4-1/16	10-1/16	7-11/16	1/16	1-1/4	6.02





Schedule 80 CPVC Technical Information
Schedule 80 CPVC Tank Adapters

NEW STYLE - TANK ADAPTER

Fipt x Fipt

Dimensions Also Applicable to 8172E-XXX & 8172V-XXX

150 psi @ 73°F

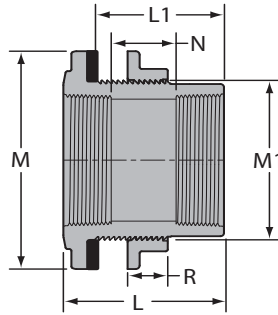

Part Number	Size	L	L1	M	M1	N	R	Approx. Wt. (Lbs.)
8172-002C	1/4	2-1/2	1-13/16	1-1/2	1-1/16	1-5/16	1/2	.11
8172-003C	3/8	2-1/2	1-13/16	1-5/8	1-3/16	1-3/8	1/2	.14
8172-005C	1/2	2-15/16	2-3/16	2-1/16	1-3/16	1-13/32	5/8	.24
8172-007C	3/4	2-15/16	2-15/32	2-1/4	1-5/8	1-1/2	5/8	.26
8172-010C	1	3-5/16	2-13/16	2-5/8	1-31/32	1-1/4	5/8	.38
8172-012C	1-1/4	3-13/32	2-27/32	3-3/32	2-5/16	1-17/32	5/8	.53
8172-015C	1-1/2	3-19/32	3-1/16	3-19/32	2-21/32	1-11/16	5/8	.72
8172-020C	2	4-1/8	3-1/4	4-7/8	3-1/4	2-3/16	3/4	1.42
8172-025C	2-1/2	4-7/8	3-7/8	5-1/4	3-13/16	2-1/4	1	2.06
8172-030C	3	5-1/2	4-1/2	6	4-9/16	2-11/16	1	2.95
8172-040C	4	5	4	7-1/2	5-1/2	2	1-1/4	3.70
8172-060C	6	5	4-3/16	9-7/8	7-31/32	1-5/32	1-1/4	6.21



Schedule 80 CPVC Technical Information
Schedule 80 CPVC Tank Adapters



NEW STYLE - TANK ADAPTER

Fipt x SR Fipt

Dimensions Also Applicable to 8172E-XXXSR & 8172V-XXXSR

150 psi @ 73°F

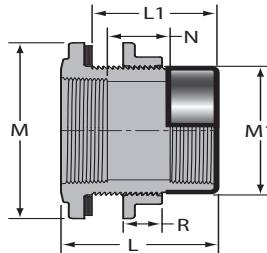

Part Number	Size	L	L1	M	M1	N	R	Approx. Wt. (Lbs.)
8172-002CSR	1/4	2-1/2	1-7/8	1-9/16	1-1/16	1-5/16	1/2	.13
8172-003CSR	3/8	2-1/2	1-13/16	1-5/8	1-3/16	1-3/8	1/2	.15
8172-005CSR	1/2	2-15/16	2-3/16	2-1/16	1-7/32	1-13/32	5/8	.25
8172-007CSR	3/4	2-15/16	2-15/32	2-1/4	1-5/8	1-3/16	5/8	.25
8172-010CSR	1	3-15/16	2-19/32	2-5/8	1-31/32	1-1/4	5/8	.36
8172-012CSR	1-1/4	3-13/32	2-27/32	3-3/32	2-5/16	1-17/32	5/8	.53
8172-015CSR	1-1/2	3-5/8	2-13/16	3-5/8	2-11/16	1-3/4	5/8	.77
8172-020CSR	2	4-1/8	3-1/4	4-27/32	3-1/32	2-1/8	3/4	1.41
8172-025CSR	2-1/2	4-7/8	3-7/8	5-1/4	3-13/16	2-1/4	1	2.11
8172-030CSR	3	5-15/32	4-17/32	5-31/32	4-17/32	2-21/32	1	3.02
8172-040CSR	4	5	4	7-1/2	5-1/2	2	1-1/4	3.80



TANK ADAPTER GASKET SECTION	SIZE	O.D.*	I.D.*	T
	1/4	1.49	0.99	1/4
	3/8	1.62	1.12	1/4
	1/2	1.98	1.41	1/4
	3/4	2.20	1.57	1/4
	1	2.60	1.90	1/4
	1-1/4	3.04	2.23	1/4
	1-1/2	3.54	2.57	1/4
	2	4.76	3.15	1/4
	2-1/2	5.13	3.70	1/4
	3	5.86	4.39	1/4
	4	7.34	5.31	1/4
	6	9.85	7.95	3/16
8	12.70	9.94	3/8	

New Style Tank Adapter Gasket & Hole Size Requirements			
Tank Adapter Size	Recommended Minimum Hole Size	Minimum Inside Curvature Radius (inches)	Maximum Tank Wall Thickness (inches)
1/4	1-1/16	2.50	.50
3/8	1-3/16	3.00	.50
1/2	1-1/2	4.00	.75
3/4	1-3/4	5.00	.75
1	2	7.00	.86
1-1/4	2-3/8	9.50	.86
1-1/2	2-3/4	12.00	.86
2	3-3/8	18.50	1.19
2-1/2	3-7/8	23.50	1.50
3	4-5/8	32.50	2.00
4	5-1/2	43.50	1.25
6	8	79.50	2.06
8	10-3/8	98.00	4.25

* Both outside and inside dimensions are +/- .01 to .03 shore hardness 50-60



Schedule 80 CPVC Technical Information
Schedule 80 CPVC Tank Adapters

OLD STYLE - TANK ADAPTER

Socket x Fipt

Dimensions Also Applicable to 871E-XXX

150 psi @ 73°F

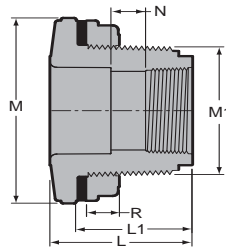

Part Number	Size	L	L1	M	M1	N	R	Approx. Wt.(Lbs.)
871-005C	1/2	2-27/32	2-11/32	2-9/32	1-9/32	1-3/8	5/8	.26
871-007C	3/4	2-23/32	2-7/32	2-1/2	1-5/8	29/32	5/8	.32
871-010C	1	2-25/32	2-1/8	2-13/16	1-7/8	25/32	21/32	.34
871-012C	1-1/4	3-1/8	2-7/16	3-29/32	2-11/32	27/32	5/8	.63
871-015C	1-1/2	3-5/32	2-21/32	3-29/32	2-11/32	3/4	5/8	.59
871-020C	2	3-3/16	2-17/32	4-31/32	3-15/32	13/16	3/4	1.43
871-030C	3	4-19/32	3-13/16	6-7/16	4-15/32	31/32	1-3/16	2.63
871-040C	4	4-7/16	3-23/32	7-7/16	5-1/2	1/2	1-1/4	3.37

OLD STYLE - TANK ADAPTER

Fipt x Fipt

Dimensions Also Applicable to 872E-XXX

150 psi @ 73°F

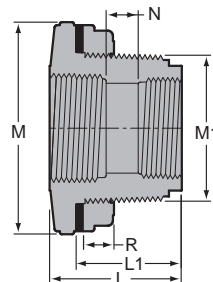

Part Number	Size	L	L1	M	M1	N	R	Approx. Wt. (Lbs.)
872-005C	1/2	2-27/32	2-11/32	2-9/32	1-9/32	1-13/32	5/8	.26
872-007C	3/4	2-23/32	2-1/4	2-1/2	1-5/8	1-5/32	5/8	.32
872-010C	1	2-25/32	2-5/16	2-13/16	1-7/8	25/32	5/8	.38
872-012C	1-1/4	3-1/8	2-5/8	3-27/32	2-11/32	1-1/8	5/8	.65
872-015C	1-1/2	3-1/8	2-5/8	3-29/32	2-11/32	1-1/16	5/8	.61
872-020C	2	3-5/32	2-3/8	5-1/16	3-7/16	1-5/32	3/4	1.42
872-030C	3	4-19/32	3-13/16	6-7/16	4-15/32	1-11/32	1-3/16	2.61
872-040C	4	4-7/16	3-1/2	7-1/2	5-1/2	15/16	1-1/4	3.47

Schedule 80 CPVC Technical Information
Schedule 80 CPVC Tank Adapters



TANK ADAPTER GASKET SECTION					Old Style Tank Adapter Gasket & Hole Size Requirements			
	SIZE	O.D.*	I.D.*	T	Tank Adapter Size	Recommended Minimum Hole Size	Minimum Inside Curvature Radius (inches)	Maximum Tank Wall Thickness (inches)
	1/2	2.25	1.33	3/16	1/2	1-3/8	3.88	1.06
	3/4	2.49	1.69	3/16	3/4	1-3/4	5.00	1.06
	1	2.79	1.94	3/16	1	2	6.12	1.06
	1-1/4	3.81	2.39	3/16	1-1/4	2-7/16	10.75	1.34
	1-1/2	3.81	2.39	3/16	1-1/2	2-7/16	10.75	1.34
	2	4.89	3.51	3/16	2	3-9/16	18.50	1.16
	3	6.30	4.49	3/16	3	4-9/16	31.00	1.75
	4	7.33	5.50	3/16	4	5-9/16	42.75	1.81

* Both outside and inside dimensions are +/- .03 shore hardness 65-70

SELF ALIGNING TANK ADAPTER

Fipt

Dimensions Also Applicable to 8172ESA-XXX & 8172VSA-XXX

75 psi @ 73°F

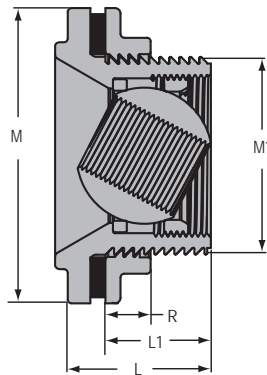

Part Number	Size	L	L1	M	M1	R	Approx. Wt. (Lbs.)
8172SA-010C	1	2-9/16	1-3/4	4-7/8	3-1/4	3/4	1.23
8172SA-020C	2	2-11/16	1-3/4	6	4-9/16	1	2.09
8172SA-030C	3	3-1/4	2-1/4	7-1/2	5-1/2	1-1/4	2.97



THERMOPLASTIC FLANGES

MOLDED & FABRICATED



TECHNICAL INFORMATION

WEIGHTS & DIMENSIONS

Contact Spears® for any information not found.



Schedule 80 CPVC Technical Information CPVC Pipe Flange Dimensions & Information

The information contained in this publication is based on current information and Product design at the time of publication and is subject to change without notification. Our ongoing commitment to product improvement may result in some variation. No representations, guarantees or warranties of any kind are made as to its accuracy, suitability for particular applications or results to be obtained therefrom. For verification of technical data or additional information not contained herein, please contact Spears® Technical Services Department [West Coast: (818) 364-1611 — East Coast: (678) 985-1263].

GENERAL INFORMATION

Recommendations For Installers And Users

Plastic piping systems should be **ENGINEERED, INSTALLED, and OPERATED** in accordance with **ESTABLISHED DESIGN AND ENGINEERING STANDARDS AND PROCEDURES** for plastic piping systems. Suitability for the intended service application should be determined by the installer and /or user prior to installation of a plastic piping system. **PRIOR TO ASSEMBLY, all piping system components should be inspected for damage or irregularities. Mating components should be checked to assure that tolerances and engagements are compatible. Do not use any components that appear irregular or do not fit properly. Contact the appropriate manufacturer of the component product in question to determine usability.**



Solvent Weld Connections — Use quality solvent cements and primers formulated for the intended service application, pipe size and type of joint. While the pipe and fitting materials may be compatible with the intended medium, the solvent cement may not be. Consult the manufacturer for suitability of use. Read and follow the cement and primer manufacturers' applications and cure time instructions thoroughly. Be sure to use the correct size applicator.

Threaded Connections — Use a quality grade thread sealant. **WARNING: SOME PIPE JOINT COMPOUNDS OR PTFE PASTES MAY CONTAIN SUBSTANCES THAT COULD CAUSE STRESS CRACKING TO PLASTIC.** Spears® Manufacturing Company recommends the use of Spears® **Blue 75™** thread sealant which has been tested for compatibility with Spears® products. Please follow the sealant manufacturer's application/installation instructions. Choice of an appropriate thread sealant other than those listed above is at the discretion of the installer. 1 to 2 turns beyond **FINGER TIGHT** is generally all that is required to make a sound plastic thread connection. Unnecessary **OVERTIGHTENING** will cause **DAMAGE TO BOTH PIPE AND FITTING.**

"Lead Free" low lead certification – unless otherwise specified, all Spears® Thermoplastic Flanges specified here-in are certified by NSF International to ANSI/NSF® Standard 61, Annex G and is in compliance with California's Health & Safety Code Section 116825 (commonly known as AB1953) and Vermont Act 193. Weighted average lead content $\leq 0.25\%$.



Schedule 80 CPVC Technical Information CPVC Pipe Flange Dimensions & Information



Bolt Kit Selection Guide

**Bolt Hardware Kits Available
For Connection of 2-Spears® Flanges
Includes Bolts, Nuts & Flat Washers for Specified Flange Size**

Order Gaskets & Bolt Kits Separately

- Pre-coated, Anti-seize Lubricated Bolts
- Available in Zinc Coated Steel, Type 316 Stainless Steel or Type 304 Stainless Steel

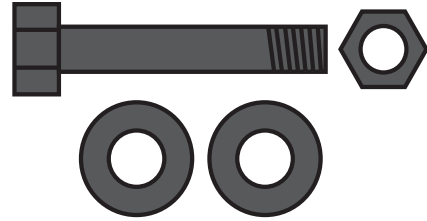

Flange Size	Bolts* Per Kit	Diameter (in.-TPI)	Length (in.)	Kit Part Number		
				Zinc	316 SS	304 SS
1/2 & 3/4	4	1/2 - 13	2	HK-005	HK1-005	HK2-005
1 & 1-1/4	4	1/2 - 13	2-1/4	HK-010	HK1-010	HK2-010
1-1/2	4	1/2 - 13	2-1/2	HK-015	HK1-015	HK2-015
2	4	5/8 - 11	3	HK-020	HK1-020	HK2-020
2-1/2	4	5/8 - 11	3-1/4	HK-025	HK1-025	HK2-025
3	4	5/8 - 11	3-1/2	HK-030	HK1-030	HK2-030
4	8	5/8 - 11	3-1/2	HK-040	HK1-040	HK2-040
5 & 6	8	3/4 - 10	4	HK-060	HK1-060	HK2-060
8	8	3/4 - 10	4-1/2	HK-080	HK1-080	HK2-080
10 & 12	12	7/8 - 9	5	HK-120	HK1-120	HK2-120

* Each Bolt Includes Nut & Two (2) Flat Washers

Bolt Torque

Recommended Bolt Torque is shown in **Table 1**. Threads should be clean and well lubricated. Actual field conditions may require variations in these recommendations. **CAUTION: UNNECESSARY OVER TORQUING WILL DAMAGE THE FLANGE.**



Table 1

Flange Size (in.)	Recommended Torque (ft. lbs.)
1/2 - 1-1/2	12
2 - 4	25
5	30
6 - 8	40
10	64
12	95
14 - 24	110

Torque Sequence

Bolt Torque sequence is shown Below in **Table 2**.

Table 2

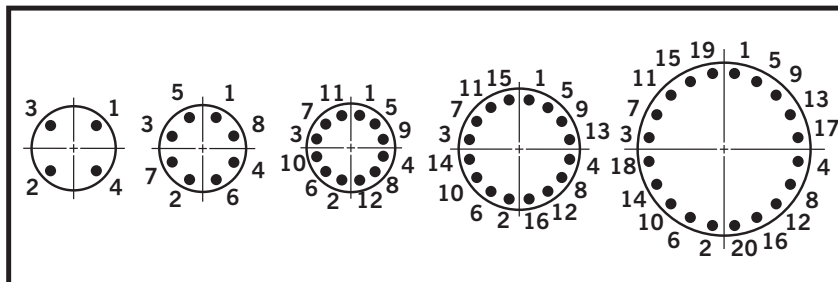



Schedule 80 CPVC Technical Information CPVC Pipe Flange Dimensions & Information

Gaskets

Full faced, 1/8" thick elastomer gaskets with a Shore "A" Durometer of approximately 70 is recommended.

Gasket Selection Guide

Following Gasket Numbers Available from Spears®

Order Gaskets & Bolt Kits Separately

- 1/8" Full-Face design with ANSI Class 150 Bolt Patterns
- Pressure rated to 150 psi @ 73°F
- Available in Buna-N, EPDM, or FKM

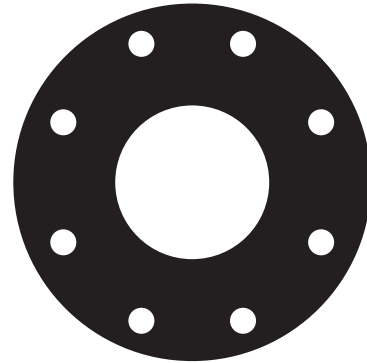

Flange Size	Bolts Per Kit	Gasket Part Number		
		Buna-N	EPDM	FKM
1/2	4	GK1-005	GK2-005	GK3-005
3/4	4	GK1-007	GK2-007	GK3-007
1	4	GK1-010	GK2-010	GK3-010
1-1/4	4	GK1-012	GK2-012	GK3-012
1-1/2	4	GK1-015	GK2-015	GK3-015
2	4	GK1-020	GK2-020	GK3-020
2-1/2	4	GK1-025	GK2-025	GK3-025
3	4	GK1-030	GK2-030	GK3-030
4	8	GK1-040	GK2-040	GK3-040
5	8	GK1-050	GK2-050	GK3-050
6	8	GK1-060	GK2-060	GK3-060
8	8	GK1-080	GK2-080	GK3-080
10	12	GK1-100	GK2-100	GK3-100
12	12	GK1-120	GK2-120	GK3-120

Flange Make-up

Once a flange is joined to pipe, the method for joining two flanges is as follows:

1. Piping runs joined to the flanges must be installed in a straight line position to the flange to avoid stress at the flange due to misalignment. Piping must also be secured and supported to prevent lateral movement which can create stress and damage the flange.
2. With gasket in place, align the bolt holes of the mating flanges by rotating the ring into position.
3. Insert all bolts, washers (two standard flat washers per bolt), and nuts.
4. Make sure the faces of the mating surfaces are flush against gasket prior to bolting down the flanges.
5. Tighten the nuts by hand until they are snug. Establish uniform pressure over the flange face by tightening the bolts in 5 ft.-lbs. increments according to the sequence shown in **Table 2** following a 180° opposing sequence.
6. Care must be taken to avoid "bending" the flange when joining a Spears® flange to a "raised face" flange, or a wafer-style valve. Do not use bolts to bring together improperly mated flanges.

Configuration Terminology

- Multi-Bolt Pattern Ring** — Bolt hole drilling accepts ANSI and Metric Flanges
- Socket** — Slip socket connection for solvent cement welding
- Spigot** — Pipe O.D. connection for solvent welding
- Fipt** — Female Iron Pipe Thread
- SR Fipt** — Spears® patented Special Reinforced (SR) plastic thread
- IPS** — Iron Pipe Size
- PIP** — Plastic Irrigation Pipe



Technical Information

Application

Molded CLASS 150 Flange fittings are coupling devices designed for joining IPS (Iron Pipe Size) plastic piping systems, where frequent disassembly may be required, and can be used as a transitional fitting for joining plastic to metal piping systems. Suitability of application is at the discretion of the user.

Pressure Rating

150 psi, water at 73°F.

Flange Types

One Piece — Available in socket configuration, sizes 1/2" through 8"; threaded and SR threaded (Special Reinforced) configuration sizes 1/2" through 4".

Van Stone Style — Two-piece design with rotating flange ring, available in socket configurations, sizes 1/2" through 16"; threaded configurations, sizes 1/2" through 4" and spigot configurations, sizes 1/2" through 12".

Blind — Closed ring design for capping off a mating flange, flanged fitting or flanged valve, available in sizes 1/2" through 12".

Materials

All injection molded flanges are produced from CPVC materials approved for potable water use by the National Sanitation Foundation (NSF®).

Glass-filled CPVC materials may be used in certain Van Stone Style flange rings and large diameter Blind flanges where additional reinforcement is deemed necessary.



Conformance Standards

Socket & Spigot — ASTM F 439 (CPVC).

Threads — ASTM F 1498.

Bolt Hole Pattern — ANSI B16.5; ASTM D 4024.

Material — ASTM D 1784 (CPVC Cell Classification 23447-B).

Weights & Dimensions

Specified minimum bolt lengths are based on the use of two Spears® Flanges, two standard flat washers, standard nut and 1/8" thick elastomer full face gasket. Mating with other brands or accessories may require variation. Bolts and gaskets are not supplied with flanges.

Dimension references:

- L** = Overall length of hub, $\pm 1/16$ inch.
- M** = Outside diameter of socket hub, $\pm 1/16$ inch.
- N** = (Laying Length) socket/spigot bottom to seal-ring face of flange, $\pm 1/16$ inch.
- R** = Height (thickness) of flange ring, $\pm 1/16$ inch.
- Max O.D.** = Outside diameter of ring, $\pm 1/16$ inch.
- Bolt Circle Diameter** = ANSI B 16.5 Standard; ASTM D 4024, $\pm 1/16$ inch.



Schedule 80 CPVC Technical Information
CPVC Pipe Flange Dimensions & Information

Flange One Piece

Socket

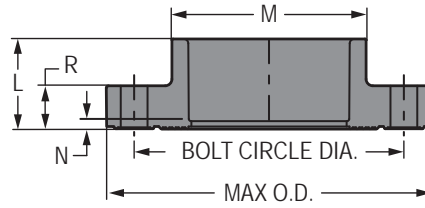

Part Number	Size	L	M	N	R	Bolt Circle Dia.	No. of Bolt Holes	Bolt Size	Min. Bolt Length	Max O.D.	Approx. Wt. (Lbs.)
851-005C	1/2	1-1/16	1-9/32	1/8	9/16	2-3/8	4	1/2	2	3-1/2	.24
851-007C	3/4	1-3/16	1-1/2	1/8	5/8	2-3/4	4	1/2	2	3-7/8	.31
851-010C	1	1-5/16	1-13/16	3/16	3/4	3-1/8	4	1/2	2-1/4	4-1/4	.47
851-012C	1-1/4	1-3/8	2-3/16	3/32	21/32	3-1/2	4	1/2	2-1/4	4-5/8	.45
851-015C	1-1/2	1-19/32	2-1/2	3/16	23/32	3-7/8	4	1/2	2-1/2	5-1/16	.61
851-020C	2	1-27/32	3	5/16	27/32	4-3/4	4	5/8	3	6	.95
851-025C	2-1/2	2-1/4	3-1/2	1/2	1	5-1/2	4	5/8	3-1/4	7	1.67
851-030C	3	2-5/16	4-9/32	3/8	1-1/16	6	4	5/8	3-1/4	7-1/2	1.81
851-040C	4	2-7/16	5-7/32	3/16	1-5/32	7-1/2	8	5/8	3-1/2	9-1/16	2.78
851-050C	5	3-1/4	6-3/8	1/4	1	8-1/2	8	3/4	3-3/4	10-1/8	3.17
851-060C	6	3-1/4	7-9/16	1/4	1-3/8	9-1/2	8	3/4	4	11	4.34
851-080C	8	4-17/32	9-3/4	1/2	1-7/16	11-11/16	8	3/4	4-1/2	13-5/8	8.02
851-100CF	10	9-7/8	11-15/16	4-5/8	1-3/8	14-1/4	12	7/8	4	16	19.27
851-120CF	12	10-11/16	14-1/8	4-7/16	1-3/8	17	12	7/8	5	19	30.67

Flange One Piece

Fipt

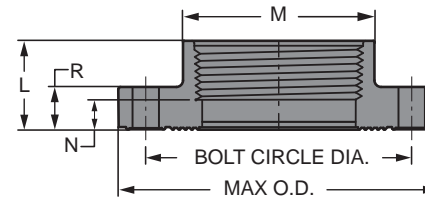

Part Number	Size	L	M	N	R	Bolt Circle Dia.	No. of Bolt Holes	Bolt Size	Min. Bolt Length	Max O.D.	Approx. Wt. (Lbs.)
852-005C	1/2	1-1/16	1-5/16	9/32	9/16	2-3/8	4	1/2	2	3-1/2	.22
852-007C	3/4	1-3/16	1-17/32	15/32	5/8	2-3/4	4	1/2	2	3-7/8	.32
852-010C	1	1-5/16	1-13/16	7/16	3/4	3-1/8	4	1/2	2-1/4	4-1/4	.48
852-012C	1-1/4	1-3/8	2-7/32	17/32	23/32	3-1/2	4	1/2	2-1/4	4-5/8	.46
852-015C	1-1/2	1-11/16	2-1/2	19/32	23/32	3-27/32	4	1/2	2-1/2	5-1/16	.64
852-020C	2	1-27/32	3	7/8	7/8	4-3/4	4	5/8	3	6	1.00
852-025C	2-1/2	2-1/4	3-1/2	15/16	1	5-1/2	4	5/8	3-1/4	7	1.41
852-030C	3	2-5/16	4-9/32	29/32	1-1/16	6	4	5/8	3-1/4	7-1/2	1.91
852-040C	4	2-1/16	5-7/16	5/16	1-1/4	7-1/2	8	5/8	3-1/2	9	2.86
852-050CF	5	6-5/8	6-1/8	5-1/4	1-5/16	8-1/2	8	3/4	3-3/4	10-1/8	5.51
852-060CF	6	6-15/16	7-1/4	5-1/2	1-5/16	9-1/2	8	3/4	4	11	7.69
852-080CF	8	8-9/16	9-7/16	6-15/16	1-7/16	11-3/4	8	3/4	4-1/2	13-1/2	13.92
852-100CF	10	7-3/8	11-3/4	5-1/2	1-3/8	14-1/4	12	7/8	5	16	20.72
852-120CF	12	7	13-15/16	5	1-3/8	17	12	7/8	4	19	22.59

Schedule 80 CPVC Technical Information
CPVC Pipe Flange Dimensions & Information



**Special Reinforced
 Flange One Piece**

SR Fipt

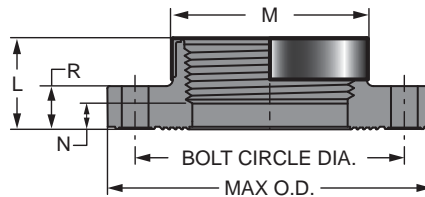

Part Number	Size	L	M	N	R	Bolt Circle Dia.	No. of Bolt Holes	Bolt Size	Min. Bolt Length	Max O.D.	Approx. Wt. (Lbs.)
852-005CSR	1/2	1-3/32	1-7/32	11/32	9/16	2-3/8	4	1/2	2	3-1/2	.22
852-007CSR	3/4	1-3/16	1-3/8	7/16	5/8	2-3/4	4	1/2	2	3-7/8	.30
852-010CSR	1	1-7/16	1-23/32	17/32	21/32	3-1/8	4	1/2	2-1/4	4-1/4	.39
852-012CSR	1-1/4	1-9/16	2-1/16	19/32	21/32	3-1/2	4	1/2	2-1/4	4-5/8	.52
852-015CSR	1-1/2	1-3/4	2-7/16	3/4	3/4	3-7/8	4	1/2	2-1/2	5	.67
852-020CSR	2	1-13/16	3-1/32	13/16	13/16	4-3/4	4	5/8	3	5-31/32	1.04
852-025CSR	2-1/2	2-1/8	3-19/32	3/8	1	5-1/2	4	5/8	3-1/4	7	1.69
852-030CSR	3	2-5/16	4-9/32	27/32	1-1/16	6	4	5/8	3-1/4	7-1/2	1.97
852-040CSR	4	2-1/2	5-1/4	1	1-5/32	7-1/2	8	5/8	3-1/2	9	2.89



BLIND FLANGE

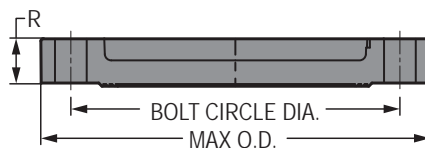

Part Number	Size	R	Bolt Circle Dia.	No. of Bolt Holes	Bolt Size	Min. Bolt Length	Max. O.D.	Approx. Wt. (Lbs.)
853-005C	1/2	17/32	2-3/8	4	1/2	2	3-17/32	.21
853-007C	3/4	5/8	2-3/4	4	1/2	2	3-7/8	.27
853-010C	1	3/4	3-1/8	4	1/2	2-1/4	4-1/4	.47
853-012C	1-1/4	23/32	3-1/2	4	1/2	2-1/4	4-5/8	.40
853-015C	1-1/2	23/32	3-27/32	4	1/2	2-1/2	5-1/16	.52
853-020C	2	27/32	4-3/4	4	5/8	3	5-31/32	.88
853-025C	2-1/2	1	5-1/2	4	5/8	3-1/4	7	1.63
853-030C	3	1-1/16	6	4	5/8	3-1/4	7-1/2	1.69
853-040C	4	1-5/32	7-1/2	8	5/8	3-1/2	9-1/16	2.98
853-060C	6	1-3/8	9-1/2	8	3/4	4	11	4.45
853-080C	8	1-7/16	11-3/4	8	3/4	4-1/2	13-1/2	7.20
853-100C	10	1-11/16	14-1/4	12	7/8	5	16	11.80
853-120C	12	1-11/16	17	12	7/8	5	19	17.20



Schedule 80 CPVC Technical Information
CPVC Pipe Flange Dimensions & Information

Flange Van Stone Style

(Two Piece)

Socket

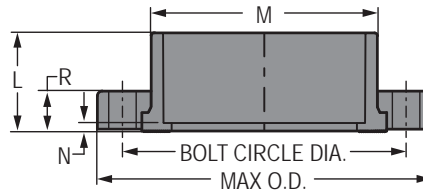

Part Number	Size	L	M	N	R	Bolt Circle Dia.	No. of Bolt Holes	Bolt Size	Min. Bolt Length	Max O.D.	Approx. Wt. (Lbs.)
854-005C	1/2	1-1/32	1-7/32	5/32	17/32	2-3/8	4	1/2	2	3-1/2	.20
854-007C	3/4	1-1/8	1-7/16	5/32	9/16	2-3/4	4	1/2	2	3-7/8	.27
854-010C	1	1-9/32	1-3/4	5/32	5/8	3-1/8	4	1/2	2-1/4	4-1/4	.37
854-012C	1-1/4	1-13/32	2-5/32	5/32	11/16	3-1/2	4	1/2	2-1/4	4-5/8	.45
854-015C	1-1/2	1-17/32	2-7/16	3/16	3/4	3-7/8	4	1/2	2-1/2	5	.60
854-020C	2	1-11/16	2-15/16	3/16	13/16	4-3/4	4	5/8	3	6	.91
854-025C	2-1/2	2	3-1/2	3/16	31/32	5-1/2	4	5/8	3-1/4	7	1.40
854-030C	3	2-1/8	4-1/4	1/4	1-1/16	6	4	5/8	3-1/4	7-1/2	1.70
854-040C	4	2-1/2	5-1/4	1/4	1-1/8	7-1/2	8	5/8	3-1/2	9	2.84
854-050C	5	3	6-1/4	3/8	1-1/8	8-1/2	8	3/4	3-3/4	10-1/8	3.60
854-060C	6	3-3/8	7-9/16	7/16	1-9/32	9-1/2	8	3/4	4	11	4.67
854-080C	8	4-3/8	9-5/16	9/32	1-3/8	11-3/4	8	3/4	4-1/2	13-1/2	7.06
854-100C	10	5-11/16	11-3/4	21/32	1-5/8	14-1/4	12	7/8	5	16	11.76
854-120C	12	7-1/4	13-3/4	5/8	1-1/2	17	12	7/8	5	19	18.50
854-140C	14	7-1/2	15-1/2	1/2	2	18-3/4	12	1	5-1/2	21	28.42
854-160C	16	8-3/4	17-3/4	3/4	2-3/8	21-1/4	16	1	6-1/2	23-1/2	24.81
854-180C	18	9	20	1/4	2-3/8	22-3/4	16	1-1/8	6-1/2	25	46.48

Flange Van Stone Style

with Plastic Solid Ring

(Two Piece)

Socket

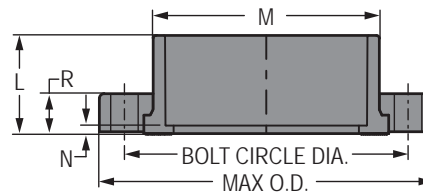

Part Number	Size	L	M	N	R	Bolt Circle Dia.	No. of Bolt Holes	Bolt Size	Min. Bolt Length	Max O.D.	Approx. Wt. (Lbs.)
S854-030C	3	2-1/8	4-1/4	1/4	1-1/16	6	4	5/8	3-1/4	7-1/2	1.70
S854-040C	4	2-1/2	5-1/4	1/4	1-1/8	7-1/2	8	5/8	1/2	9	2.84
S854-060C	6	3-3/8	7-9/16	7/16	1-9/32	9-1/2	8	3/4	4	11	4.67
S854-080C	8	4-3/8	9-5/16	3/8	1-3/8	11-3/4	8	3/4	4-1/2	13-1/2	7.06
S854-100C	10	5-11/16	11-3/4	11/16	1-5/8	14-1/4	12	7/8	5	16	11.76
S854-120C	12	7-1/4	13-3/4	5/8	1-3/4	17	12	7/8	5	19	19.13

Schedule 80 CPVC Technical Information
CPVC Pipe Flange Dimensions & Information



Flange Van Stone Style

with Multi-Bolt Pattern Ring

(Two Piece)

Socket

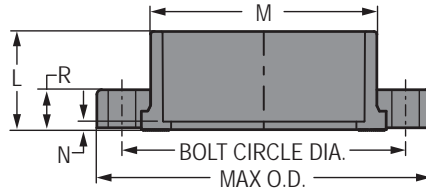

Part Number	Size	L	M	N	R	Bolt Circle Dia.		No. of Bolt Holes	Bolt Size	Max O.D.	Approx. Wt. (Lbs.)
						Min	Max				
M854-020C	2	1-11/16	2-15/16	3/16	13/16	4-1/2	4-15/16	4	5/8	6	.93
M854-060C	6	3-3/8	7-9/16	7/16	1-9/32	9-7/32	9-1/2	8	3/4	11	5.09
M854-080C	8	4-3/8	9-5/16	3/8	1-3/8	11-1/2	11-3/4	8	3/4	13-1/2	7.21

Flange Van Stone Style

(Two Piece)

Flt

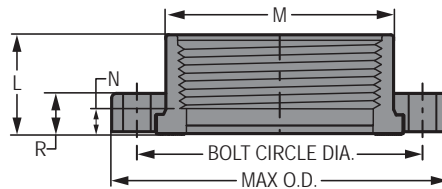

Part Number	Size	L	M	N	R	Bolt Circle Dia.	No. of Bolt Holes	Bolt Size	Min. Bolt Length	Max. O.D.	Approx. Wt. (Lbs.)
855-007C	3/4	1-5/32	1-3/8	13/32	9/16	2-3/4	4	1/2	2	3-7/8	.28
855-010C	1	1-1/4	1-3/4	5/16	5/8	3-1/8	4	1/2	2-1/4	4-1/4	.39
855-012C	1-1/4	1-3/8	2-1/8	13/32	11/16	3-1/2	4	1/2	2-1/4	4-5/8	.47
855-015C	1-1/2	1-15/32	2-7/16	13/32	3/4	3-7/8	4	1/2	2-1/2	5	.61
855-020C	2	1-9/16	2-31/32	1/2	13/16	4-3/4	4	5/8	3	6	.94
855-025C	2-1/2	2	3-9/16	7/16	1	5-1/2	4	5/8	3-1/4	7	1.50
855-030C	3	2-1/8	4-1/4	1/2	1-1/16	6	4	5/8	3-1/4	7-1/2	1.79
855-040C	4	2-1/16	5-1/4	3/8	1-1/4	7-1/2	8	5/8	3-1/2	9	2.78
855-060CF	6	6-3/8	7-3/16	4-15/16	1-1/4	9-1/2	8	3/4	4	11	7.69
855-080CF	8	8-1/8	9-5/16	6-7/16	1-1/2	11-3/4	8	3/4	4-1/2	13-1/2	13.92
855-100CF	10	10-3/8	11-9/16	8-9/16	1-11/16	14-1/4	12	7/8	5	16	20.72
855-120CF	12	11-13/16	13-3/4	9-3/4	1-5/8	17	12	7/8	5	19	34.00



Schedule 80 CPVC Technical Information
CPVC Pipe Flange Dimensions & Information

Flange Van Stone Style

(Two Piece)

Spigot

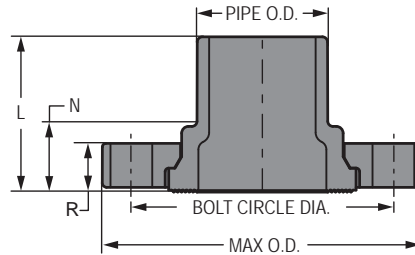

Part Number	Size	L	N	R	Bolt Circle Dia.	No. of Bolt Holes	Bolt Size	Min. Bolt Length	Max. O.D.	Approx. Wt. (Lbs.)
856-005C	1/2	1-3/4	29/32	17/32	2-3/8	4	1/2	2	3-1/2	.21
856-007C	3/4	1-15/16	31/32	9/16	2-3/4	4	1/2	2	3-7/8	.30
856-010C	1	2-3/16	1-1/32	5/8	3-1/8	4	1/2	2-1/4	4-1/4	.41
856-012C	1-1/4	2-11/32	1-3/32	11/16	3-1/2	4	1/2	2-1/4	4-5/8	.50
856-015C	1-1/2	2-5/8	1-9/32	3/4	3-7/8	4	1/2	2-1/2	5	.65
856-020C	2	2-7/8	1-11/32	13/16	4-3/4	4	5/8	3	6	1.00
856-025C	2-1/2	3-1/16	1-9/32	1	5-1/2	4	5/8	3-1/4	7	1.54
856-030C	3	3-3/8	1-7/16	1-1/16	6	4	5/8	3-1/4	7-1/2	1.88
856-040C	4	3-7/8	1-5/8	1-1/4	7-1/2	8	5/8	3-1/2	9	3.12
856-060C	6	4-3/4	1-25/32	1-9/32	9-1/2	8	3/4	4	11	4.79
856-080C	8	5-7/8	1-15/16	1-3/8	11-3/4	8	3/4	4-1/2	13-1/2	8.17
856-100C	10	8	2-1/4	1-5/8	14-1/4	12	7/8	5	16	16.09
856-120C	12	8-1/2	2-3/16	1-5/8	17	12	7/8	5	19	22.70

Flange Van Stone Style

with Multi-Bolt Pattern Ring

(Two Piece)

Spigot

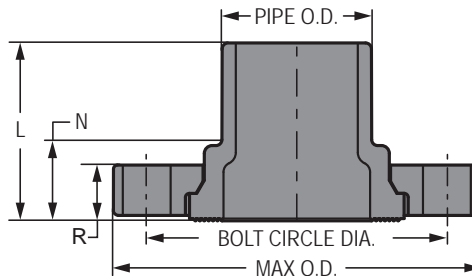

Part Number	Size	L	N	R	Bolt Circle Dia.		No. of Bolt Holes	Bolt Size	Max. O.D.	Approx. Wt. (Lbs.)
					Min.	Max.				
M856-020C	2	2-7/8	1-11/32	13/16	4-1/2	4-15/16	4	5/8	6	1.00
M856-060C	6	4-3/4	1-25/32	1-9/32	9-7/32	9-1/2	8	3/4	11	5.21
M856-080C	8	5-7/8	1-15/16	1-3/8	11-1/2	11-3/4	8	3/4	13-1/2	8.32



Technical Information

Application

Fabricated IPS and PIP Flange fittings are coupling devices designed for joining IPS (Iron Pipe Size) or PIP (Plastic Irrigation Pipe) plastic piping systems, where frequent disassembly may be required. These flanges can be used as transitional fittings for joining IPS-to-IPS, PIP-to-PIP, IPS-to-PIP, or plastic to metal piping systems. Suitability of application is at the discretion of the user.

Pressure Rating

All standard fabricated flanges are Van Stone Style (except blind flange) — two piece design with rotating flange ring.

Class 150 IPS Flanges (with steel ring): 150 psi, water at 73°F.

IPS Flanges 18" - 24" (with plastic ring): 50 psi, water at 73°F.

IPS Flanges, Class 300 Bolt Pattern (with plastic ring): 1/2" - 16" 150 psi, 18" - 24" 50 psi, water at 73°F.

Blind Flanges, 14" - 24": 50 psi, water at 73°F.

PIP Flanges, 6" - 16" (with plastic ring & molded IPS flanges w/PIP Adapters): 125 psi, water at 73°F

PIP Flanges, 18" - 24" (with steel ring): 125 psi, water at 73°F

Flange Types

Van Stone Style Class 150 IPS (with steel ring) — Fabricated PVC body with steel flange ring, available in sizes 18" through 24", slip socket and 14" through 24", spigot.

Van Stone Style IPS (with plastic ring) — Fabricated PVC body with PVC flange ring, available in sizes 18" through 24", slip socket and 14" through 24", spigot.

Van Stone Style PIP (with plastic ring) — PIP adapter fabricated to injection molded PVC Van Stone Style IPS flange, available in sizes 6" through 16", slip socket.

Van Stone Style PIP (with steel ring) — Fabricated PVC body with steel flange ring, available in sizes 14" through 24", slip socket.

Blind — Closed ring design for capping off a mating flange; fabricated PVC available in sizes 5" and 14" through 24".



Special Note On PIP Flange Sizes

In order to facilitate connections between IPS and PIP systems, all Plastic Irrigation Pipe flanges are fabricated with PIP sockets using standard IPS Flange Rings. These are indicated in dimension tables under "Size" as (nominal IPS flange size) x (actual PIP O.D.), such as: 6" x 6.140".

To better meet user needs, Spears® offers flanges for 15.300" O.D. PIP with either 14" or 16" IPS Flange Rings. In addition, both 18.360" and 18.701" O.D. PIP are offered with 18" IPS Flange Rings.

Materials

All fabricated flanges are produced from CPVC materials approved for potable water use by the National Sanitation Foundation (NSF®). Steel flange rings are carbon steel.

Conformance Standards

Materials — ASTM D 1784 (CPVC Cell Classification 23447-B).

Weights & Dimensions

Specified minimum bolt lengths are based on the use of two Spears® Flanges, two standard flat washers, standard nut and 1/8" thick elastomer full face gasket. Mating with other brands or accessories may require variations.

Note: Bolts and gaskets are not supplied with flanges.

Dimension references:

L = Overall length of hub, ± 1/2 inch.

M = Outside diameter of socket hub, ± 1/4 inch.

N = (Laying Length) socket bottom to seal-ring face of flange, ± 1/2 inch.

R = Height (thickness) of flange ring, ± 1/16 inch.

Max O.D = Outside diameter of ring, ± 1/16 inch.

Bolt Circle Diameter = ANSI B16.5 Standard; ASTM D 4024, ± 1/16 inch.



Schedule 80 CPVC Technical Information
CPVC Pipe Flange Dimensions & Information

Blind Flange

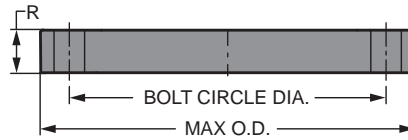

Part Number	Size	R	Bolt Circle Dia.	No. of Bolt Holes	Bolt Size	Min. Bolt Length	Max. O.D.	Approx. Wt. (Lbs.)
853-050CF	5	1	8-1/2	8	3/4	4-1/8	10-1/16	3.90
853-140CF	14	1-1/2	18-3/4	12	1	4-1/8	21	28.39
853-160CF	16	1-1/2	21-1/4	16	1	4-1/8	23-1/2	37.21
853-180CF	18	1-1/2	22-3/4	16	1-1/8	4-1/8	25	43.47
853-200CF	20	1-1/2	25	20	1-1/8	4-1/8	27-1/2	52.43
853-240CF	24	1-1/2	29-1/2	20	1-1/4	5-1/2	32	68.15

Flange Van Stone Style Class 300

(with Plastic Ring)

Socket

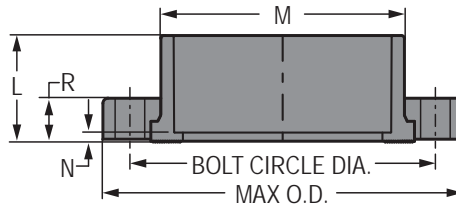

Part Number	Size	L	M	N	R	Bolt Circle Dia.	No. of Bolt Holes	Bolt Size	Min. Bolt Length	Max O.D.
854-005CL300C	1/2	1	1-3/16	3/16	1/2	2-5/8	4	1/2	2	3-3/4
854-007CL300C	3/4	1-1/8	1-3/8	3/16	1	3-1/4	4	5/8	3-1/2	4-5/8
854-010CL300C	1	1-1/4	1-3/4	3/16	1	3-1/2	4	5/8	3-1/2	4-7/8
854-012CL300C	1-1/4	1-3/8	2-1/8	1/8	1	3-7/8	4	5/8	3-1/2	5-1/4
854-015CL300C	1-1/2	1-1/2	2-7/16	3/16	1	4-1/2	4	5/8	3-1/2	6-1/8
854-020CL300C	2	1-11/16	2-15/16	3/16	1	5	8	5/8	3-1/2	6-1/2
854-025CL300C	2-1/2	2	3-9/16	1/4	1	5-7/8	8	3/4	3-1/2	7-1/2
854-030CL300C	3	2-1/8	4-1/4	1/4	1	6-5/8	8	3/4	3-1/2	8-1/4
854-040CL300C	4	2-1/2	5-1/4	1/4	1-1/2	7-7/8	8	3/4	4-1/2	10
854-060CL300C	6	3-7/16	7-9/16	3/8	1-1/2	10-5/8	12	3/4	4-1/2	12-1/2
854-080CL300C	8	4-3/8	9-3/8	5/16	1-1/2	13	12	7/8	4-1/2	15
854-100CL300C	10	5-11/16	11-3/4	5/8	1-1/2	15-1/4	16	1	4-1/2	17-1/2
854-120CL300C	12	7-5/16	13-13/16	9/16	1-1/2	17-3/4	16	1-1/8	4-1/2	20-1/2
854-140CL300C	14	7-9/16	15-9/16	9/16	2	20-1/4	20	1-1/8	5-1/2	23
854-160CL300C	16	8-9/16	17-3/4	9/16	2	22-1/2	20	1-1/4	6	25-1/2

Schedule 80 CPVC Technical Information
CPVC Pipe Flange Dimensions & Information



Flange Van Stone Style IPS

(with Plastic Ring)

Socket

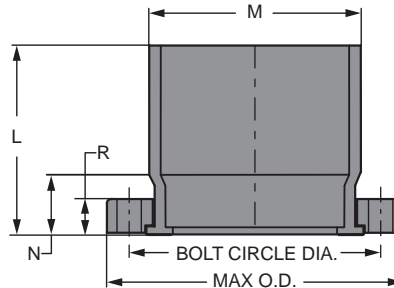

Part Number	Size	L	M	N	R	Bolt Circle Dia.	No. of Bolt Holes	Bolt Size	Min. Bolt Length	Max O.D.	Approx. Wt. (Lbs.)
854-180CFP	18	15	19-1/8	6	1-1/2	22-3/4	16	1-1/8	4-1/8	25	39.00
854-200CFP	20	16	21-3/16	6	1-1/2	25	20	1-1/8	5-1/2	27-1/2	60.20
854-240CFP	24	19	25-3/8	7	1-1/2	29-1/2	20	1-1/4	5-1/2	32	91.30

Flange Van Stone Style IPS

(with Steel Ring)

Socket

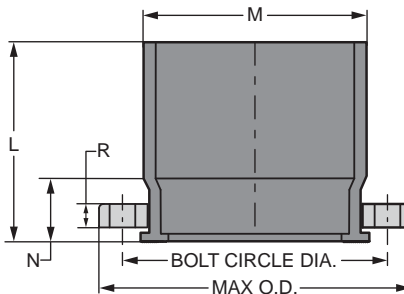

Part Number	Size	L	M	N	R	Bolt Circle Dia.	No. of Bolt Holes	Bolt Size	Min. Bolt Length	Max O.D.	Approx. Wt. (Lbs.)
854-180CFS	18	14	19-1/8	5	1/2	22-3/4	16	1-1/8	3	25	58.88
854-200CFS	20	15	21-3/16	5	1/2	25	20	1-1/8	3	27-9/16	69.46
854-240CFS	24	18	25-3/8	6	1/2	29-1/2	20	1-1/4	3	32	96.59

