

Schedule 80 PVC Technical Information
Schedule 80 PVC Pipe Dimensions & Pressure Ratings



Schedule 80 Pipe Dimensions & Pressure Ratings

Nom. Pipe Size (in)	O.D.	Average I.D.	Min. Wall	Nominal Wt./Ft.	Maximum W.P. PSI*
1/4	.540	.282	0.119	0.117	1130
3/8	.675	.403	0.126	0.162	920
1/2	.840	.526	0.147	0.231	850
3/4	1.050	.722	0.154	0.314	690
1	1.315	.936	0.179	0.462	630
1-1/4	1.660	1.255	0.191	0.654	520
1-1/2	1.900	1.476	0.200	0.793	470
2	2.375	1.913	0.218	1.097	400
2-1/2	2.875	2.290	0.276	1.674	420
3	3.500	2.864	0.300	2.242	370
3-1/2	4.000	3.326	0.318	2.735	350
4	4.500	3.786	0.337	3.277	320
5	5.563	4.768	0.375	4.078	290
6	6.625	5.709	0.432	6.258	280
8	8.625	7.565	0.500	9.506	250
10	10.750	9.493	0.593	14.095	230
12	12.750	11.294	0.687	19.392	230
14	14.000	12.410	0.750	23.261	220
16	16.000	14.213	0.843	29.891	220
18	18.000	16.014	0.937	35.419	220
20	20.000	17.814	1.031	45.879	220
24	24.000	21.418	1.218	64.959	210



Maximum PVC Service Temperature 140°F

Pressure De-rating at Elevated Temperatures

The pressure ratings given above are for water, non-shock, @ 73°F. The specified derating factors for PVC are suitable for pipe conveying water at elevated temperatures. To determine elevated temperature rating, multiply 73°F [23°C] pressure rating by appropriate factor shown in the table for desired operating temperature. When working near maximum specified temperature, solvent cement joints are recommended in place of threaded connections. Where disassembly is required at elevated temperatures use Spears® Special reinforced (SR) adapters, flanges, unions or grooved coupling connections. Spears® recommends that only Schedule 80 or heavier wall thickness pipe should be threaded.

PVC Pipe

Operating Temp (°F)	De-Rating Factor
73	1.00
80	0.88
90	0.75
100	0.62
110	0.51
120	0.40
130	0.31
140	0.22

EX: 2" PVC SCHEDULE 80 @ 120°F = 400 psi x 0.40 = 160 psi max. @ 120°F.

See Plastic Pipe Engineering Guide for additional information



Schedule 80 PVC Fittings



TECHNICAL INFORMATION WEIGHTS & DIMENSIONS

Contact Spears® for any information not found.



PVC Performance Engineered & Tested



SPEARS® Schedule 80 PVC product designs combine years of proven experience with computer generated stress analysis to yield the optimum physical structure and performance for each fitting. Material reinforcement is uniformly placed in stress concentration areas for substantially improved pressure handling capability. Resulting products are subjected to numerous verification tests to assure obtaining the very best PVC fittings available.

1/4" Through 14" Availability

Spears® comprehensive line of PVC injection molded fittings and extruded pipe offers a variety of configurations in sizes 1/4" through 14". Schedule 80 fittings are manufactured to ASTM D 2467 and pipe is produced to ASTM D 1785. Spears® exclusive CL150 Flanges are produced in sizes 1/2" - 18" with ANSI B16.5 bolt patterns, plus numerous Unions, Saddles, Transition and Specialty fittings in a variety of sizes.

Exceptional Chemical & Corrosion Resistance

Unlike metal, PVC fittings and pipe never rust, scale, or pit, and will provide many years of maintenance-free service and extended system life.

High Temperature Ratings

PVC thermoplastic can handle fluids at service temperatures up to 140°F (60°C), allowing a wide range of process applications, including corrosive fluids.

Lower Installation Costs

Substantially lower material costs than steel alloys or lined steel, combined with lighter weight and ease of installation, can reduce installation costs by as much as 60% over conventional metal systems.

Higher Flow Capacity

Smooth interior walls result in lower pressure loss and higher volume than conventional metal fittings.

Additional Fabricated Configurations through 36"

Extra large, hard-to-find, and custom configurations are fabricated from NSF® Certified pipe. Fittings are engineered and tested to provide full pressure handling capabilities according to Spears® specifications.

Advanced Design Specialty Fittings

Spears® wide range of innovative, improved products include numerous metal-to-plastic transition fittings and unions with Spears® patented special reinforced (SR) plastic threads.

PVC Valves

SPEARS® PVC Valve products are available for total system compatibility and uniformity.



PVC Sample Engineering Specifications

All PVC Schedule 80 pipe and fittings shall be produced by Spears® Manufacturing Company from PVC Type I, cell classification 12454, conforming to ASTM Standard D 1784. All PVC injection molded Schedule 80 fittings and extruded pipe shall be Certified for potable water service by NSF International. All Schedule 80 fittings shall be manufactured in strict compliance to ASTM D 2467 and Schedule 80 pipe shall be manufactured in strict compliance to ASTM D 1785. All fabricated fittings shall be produced in accordance with Spears® General Specifications for Fabricated Fittings. All PVC flanges shall be designed and manufactured to meet CL150 bolt pattern per ANSI Standard B16.5 and rated for a maximum internal pressure of 150 psi, non-shock at 73°F.



Schedule 80 PVC Technical Information Schedule 80 Product Overview

The information contained in this publication is based on current information and Product design at the time of publication and is subject to change without notification. Our ongoing commitment to product improvement may result in some variation. No representations, guarantees or warranties of any kind are made as to its accuracy, suitability for particular applications or results to be obtained therefrom. For verification of technical data or additional information not contained herein, please contact Spears® Technical Services Department [West Coast: (818) 364-1611 — East Coast: (678) 985-1263].

General Information

Recommendations For Installers And Users



Plastic piping systems should be **ENGINEERED, INSTALLED** and **OPERATED** in accordance with **ESTABLISHED DESIGN AND ENGINEERING STANDARDS AND PROCEDURES** for plastic piping systems. Suitability for the intended service application should be determined by the installer and/or user prior to installation of a plastic piping system. **PRIOR TO ASSEMBLY, all piping system components should be inspected for damage or irregularities. Mating components should be checked to assure that tolerances and engagements are compatible. Do not use any components that appear irregular or do not fit properly. Contact the appropriate manufacturer of the component product in question to determine usability. Consult all applicable codes and regulations for compliance prior to installation.**

Solvent Weld Connections — Use quality solvent cements and primers formulated for the intended service application, pipe size and type of joint. While the pipe and fitting materials may be compatible with the intended medium, the solvent cement may not be. Consult the manufacturers for suitability of use. Read and follow the cement and primer manufacturers' applications and cure time instructions thoroughly. Be sure to use the correct size applicator.

Threaded Connections — Use a quality grade thread sealant. **WARNING: SOME PIPE JOINT COMPOUNDS OR PTFE PASTES MAY CONTAIN SUBSTANCES THAT COULD CAUSE STRESS CRACKING TO PLASTIC.** Spears® Manufacturing company recommends the use of Spears® **BLUE 75™** Thread Sealant which has been tested for compatibility with Spears® products. Please follow the sealant manufacturers' application/installation instructions. Choice of an appropriate thread sealant other than those listed above is at the discretion of the installer. 1 to 2 turns beyond **FINGER TIGHT** is generally all that is required to make a sound plastic threaded connection. Unnecessary **OVERTIGHTENING** will cause **DAMAGE TO BOTH PIPE AND FITTING.**

Standards and Specifications

Molded Schedule 80 PVC products are manufactured to ASTM D 2467 for use with pipe manufactured to ASTM D 1785. Certain products carry reduced pressure handling capability and have maximum internal pressure ratings at 73°F noted.

Fabricated Schedule 80 PVC pressure fittings (part numbers ending with "F") are manufactured to Spears® specifications for use with pipe manufactured to ASTM D 1785. General Specifications for Standard Fabricated Fittings for additional information.

All specified Schedule 80 PVC products are manufactured from materials certified by NSF® for use in potable water service.

"Lead Free" low lead certification – unless otherwise specified, all Spears® Schedule 80 fittings specified here-in are certified by NSF International to ANSI/NSF® Standard 61, Annex G and is in compliance with California's Health & Safety Code Section 116825 (commonly known as AB1953) and Vermont Act 193. Weighted average lead content $\leq 0.25\%$. Spears® PVC Pipe, Fittings and Valves have always been lead-free and Certified by NSF International for use in potable water systems. Spears® offers a wide range of lead-free specialty fittings and transition adapters for plumbing applications. However, certain brass threaded adapter fittings for applications that are not intended to convey water for human consumption through drinking or cooking are still produced and available.

Schedule 80 PVC Technical Information
Schedule 80 Fittings



ASTM STANDARD DIMENSIONS

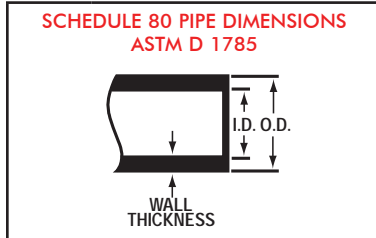

Nominal Pipe Size In.	Mean Outside Diameter In.	O. D. Tolerance In.	Minimum Wall Thickness In.
1/8	0.405	± 0.004	0.095
1/4	0.540	± 0.004	0.119
3/8	0.675	± 0.004	0.126
1/2	0.840	± 0.004	0.147
3/4	1.050	± 0.004	0.154
1	1.315	± 0.005	0.179
1-1/4	1.660	± 0.005	0.191
1-1/2	1.900	± 0.006	0.200
2	2.375	± 0.006	0.218
2-1/2	2.875	± 0.007	0.276
3	3.500	± 0.008	0.300
4	4.500	± 0.009	0.337
5	5.563	± 0.010	0.375
6	6.625	± 0.011	0.432
8	8.625	± 0.015	0.500
10	10.750	± 0.015	0.593
12	12.750	± 0.015	0.687

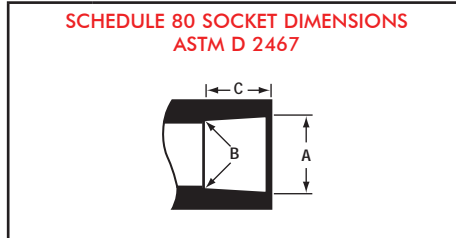

Nominal Size In.	Diameter			Socket Length Minimum C
	Entrance A	Bottom B	Tolerance A	
1/8	0.417	0.401	± 0.004	0.500
1/4	0.552	0.536	± 0.004	0.625
3/8	0.687	0.671	± 0.004	0.750
1/2	0.848	0.836	± 0.004	0.875
3/4	1.058	1.046	± 0.004	1.000
1	1.325	1.310	± 0.005	1.125
1-1/4	1.670	1.655	± 0.005	1.250
1-1/2	1.912	1.894	± 0.006	1.375
2	2.387	2.369	± 0.006	1.500
2-1/2	2.889	2.868	± 0.007	1.750
3	3.516	3.492	± 0.008	1.875
4	4.518	4.491	± 0.009	2.250
5	5.583	5.553	± 0.010	2.625
6	6.647	6.614	± 0.011	3.000
8	8.655	8.610	± 0.015	4.000
10	10.780	10.735	± 0.015	5.000
12	12.780	12.735	± 0.015	6.000
14	14.030	13.985	± 0.015	7.000

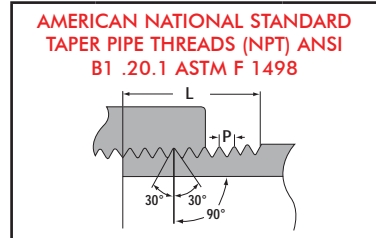

Nominal Size In.	Threads Per Inch	Effective Thread Length L	Pitch Of Thread P
1/8	27	0.2639	0.03704
1/4	18	0.4018	0.05556
3/8	18	0.4078	0.05556
1/2	14	0.5337	0.07143
3/4	14	0.5457	0.07143
1	11-1/2	0.6828	0.08696
1-1/4	11-1/2	0.7068	0.08696
1-1/2	11-1/2	0.7235	0.08696
2	11-1/2	0.7565	0.08696
2-1/2	8	1.1375	0.12500
3	8	1.2000	0.12500
4	8	1.3000	0.12500
5	8	1.4063	0.12500
6	8	1.5125	0.12500
8	8	1.7125	0.12500



STANDARD COMPARISONS

SPEARS® IPS-to-Metric transition unions are listed by nominal size. The chart below compares nominal and actual* pipe O.D. for each size according to the designated standard.

JIS K6741 (mm)		DIN 8062 (mm)		ASTM D1785 (in.)		NPT—ANSI B1.20.1** Tapered Thread		BSP—BS21, DIN 2999, ISO 7/1 Thread	
Nominal	Actual*	O.D.	Actual*	Nominal	Actual*	Designation	Threads/in.	Designation	Threads/25.4mm
16	22	15	20	1/2	.840	1/2	14	1/2	14
20	26	20	25	3/4	1.050	3/4	14	3/4	14
25	32	25	32	1	1.315	1	11.5	1	11
30	38	38	40	1-1/4	1.660	1-1/4	11.5	1-1/4	11
40	48	40	50	1-1/2	1.900	1-1/2	11.5	1-1/2	11
50	60	50	63	2	2.375	2	11.5	2	11
75	89	80	90	3	3.500	3	8	3	11
100	114	100	110	4	4.500	4	8	4	11

*Specified dimension, certain tolerances apply

**NPT and BSP have different thread angles and not compatible.



Schedule 80 PVC Technical Information

Schedule 80 Fittings

Injection Molded Dimensions References:

- G** = (LAYING LENGTH) intersection of center lines to bottom of socket/thread; 90° elbows, tees, crosses; ± 1/32 inch.
- H** = Intersection of center lines to face of fitting; 90° elbow tees, crosses; ± 1/32 inch.
- J** = Intersection of center lines to bottom of socket/thread; 45° elbows; ± 1/32 inch

- L** = Overall length of fittings; ± 1/16 inch.
- H** = Outside diameter of socket/thread hub; ± 1/16 inch.
- N** = Socket bottom to socket bottom; couplings; ± 1/16 inch
- W** = Height of cap; ± 1/16 inch.

Fabricated Dimension References:

- G** = (LAYING LENGTH) intersection of center lines to bottom of socket/thread; 90° elbows, tees, crosses ± 1/4 inch; 14" & larger ± 1/2 inch.
- H** = Intersection of center lines to face of fitting; 90° elbows ± 1/4 inch, 14" & larger ± 3/4 inch; wyes ± 1/2 inch; tees, crosses ± 1/4 inch; 14" & larger ± 1/2 inch.
- J** = Intersection of center lines to bottom of socket/thread; 45° elbows; ± 1/4 inch; 14" & larger ± 1/2 inch.

- L** = Overall length of fittings; ± 1/2 inch; 14" & larger ± 1 inch; wyes ± 1 inch.
- M** = Outside diameter of socket/thread hub; ± 1/4 inch.
- N** = Socket bottom to socket bottom; couplings; ± 1/2
- W** = Height of cap; ± 1/4 inch.

Typical Fabricated Dimension References

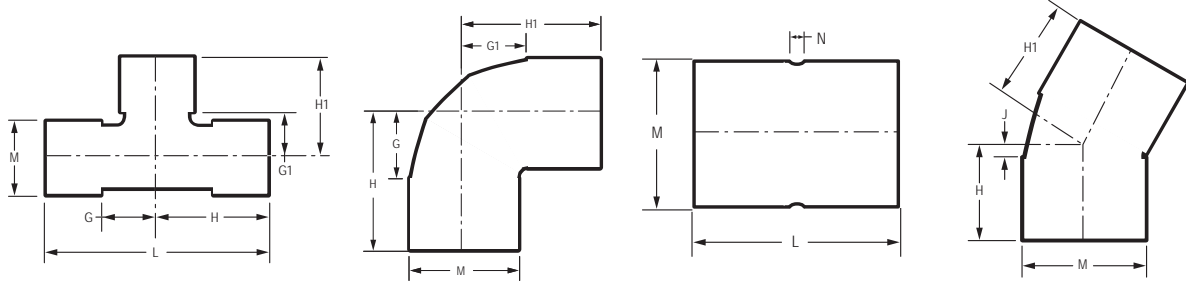

TEE

Socket x Socket x Socket

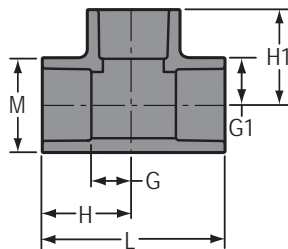

Part Number	Size	G	G1	H	H1	L	M	Approx. Wt. (Lbs.)
801-002	1/4	5/16	5/16	31/32	31/32	1-15/16	27/32	.04
801-003	3/8	15/32	15/32	1-1/4	1-1/4	2-1/2	31/32	.06
801-005	1/2	17/32	17/32	1-15/32	1-15/32	2-15/16	1-3/16	.11
801-007	3/4	21/32	21/32	1-11/16	1-11/16	3-13/32	1-13/32	.16
801-010	1	7/8	7/8	2	2	4	1-3/4	.27
801-012	1-1/4	1-1/32	1-1/32	2-9/32	2-9/32	4-19/32	2-3/32	.39
801-015	1-1/2	1-3/16	1-3/16	2-9/32	2-9/32	5-1/8	2-3/8	.52
801-020	2	1-7/16	1-7/16	2-15/16	2-15/16	5-7/8	2-7/8	.80
801-025	2-1/2	1-3/4	1-3/4	3-1/2	3-1/2	7-1/32	3-15/32	1.46
801-030	3	2-1/16	2-1/16	3-31/32	3-31/32	7-15/16	4-5/32	2.16
801-040	4	2-1/2	2-1/2	4-3/4	4-3/4	9-1/2	5-1/4	3.52

Schedule 80 PVC Technical Information
Schedule 80 Fittings



TEE (continued)

Socket x Socket x Socket

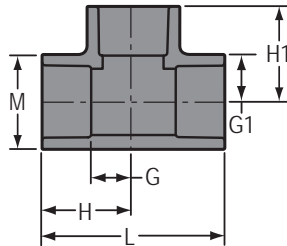

Part Number	Size	G	G1	H	H1	L	M	Approx. Wt. (Lbs.)
801-050	5	3-1/8	3-1/8	5-25/32	5-25/32	11-5/8	6-13/32	6.03
801-050F	5	5-1/2	5-1/2	8-1/2	8-1/2	17	6-5/16	13.26
801-060	6	3-25/32	3-25/32	6-13/16	6-13/16	13-5/8	7-5/8	10.78
801-080	8	4-13/16	4-13/16	8-7/8	8-7/8	17-3/4	9-23/32	21.21
801-080F	8	7-5/8	7-5/8	11-7/8	11-7/8	23-3/4	9-5/8	22.84
801-100	10	5-3/4	5-3/4	10-13/16	10-13/16	21-5/8	11-19/32	37.89
801-100F	10	9	9	14-1/4	14-1/4	28-1/2	11-15/16	39.82
801-120	12	6-15/16	6-15/16	12-15/16	12-15/16	25-7/8	14-1/4	54.45
801-120F	12	11-1/4	11-1/4	17-1/2	17-1/2	35	14-1/8	67.13
801-140	14	7-1/32	7-1/32	14-7/32	14-1/32	28-7/16	15-21/32	63.61
801-140F	14	12-1/4	12-1/4	19-1/4	19-1/4	38-1/2	15-1/2	103.37
801-160F	16	13	13	21	21	42	17-11/16	144.87
801-180F	18	13-3/4	13-3/4	22-3/4	22-3/4	45-1/2	19-7/8	182.75
801-200F	20	16-3/8	16-3/8	26-3/8	26-3/8	52-3/4	22-1/16	284.24
801-240F	24	20-1/4	20-1/4	32-1/4	32-1/4	64-1/2	26-7/16	335.00



REDUCING TEE

Socket x Socket x Socket

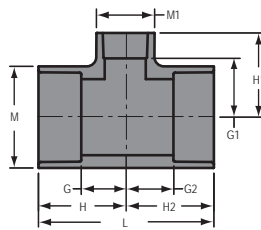

Part Number	Size	G	G1	G2	H	H1	H2	L	M	M1	Approx. Wt. (Lbs.)
801-101	3/4x3/4x1/2	19/32	23/32	19/32	1-19/32	1-19/32	1-19/32	3-3/16	1-13/32	1-3/16	.14
801-130	1x1x1/2	19/32	7/8	19/32	1-23/32	1-3/4	1-23/32	3-7/16	1-3/4	1-3/16	.20
801-131	1x1x3/4	11/16	27/32	11/16	1-27/32	1-27/32	1-27/32	3-21/32	1-3/4	1-13/32	.23
801-157	1-1/4x1x3/4	11/16	1-1/16	5/8	1-15/16	2-1/16	1-7/8	3-13/16	2-1/8	1-7/16	.30
801-158	1-1/4x1x1	13/32	15/16	13/32	2-1/8	1-31/32	1-15/16	4	2-1/16	1-11/16	.33
801-159	1-1/4x1x1-1/4	15/16	1-1/32	7/8	2-3/16	2-5/32	2-1/8	4-5/16	2-1/16	2-1/16	.39
801-166 ¹	1-1/4x1-1/4x1/2	7/8	1-13/32	7/8	2-3/32	2-3/8	2-3/32	4-7/32	2-1/8	1-3/4	.42
801-167	1-1/4x1-1/4x3/4	5/8	31/32	5/8	1-15/16	1-31/32	1-15/16	3-7/8	2-1/8	1-13/32	.28
801-168	1-1/4x1-1/4x1	27/32	1-1/32	27/32	2-3/32	2-5/32	2-3/32	4-7/32	2-3/32	1-3/4	.34

¹ Outlet sized with bushing



Schedule 80 PVC Technical Information
Schedule 80 Fittings

REDUCING TEE (continued)
Socket x Socket x Socket

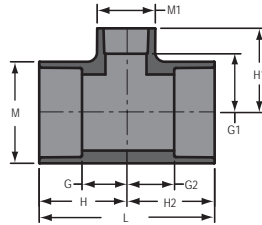

Part Number	Size	G	G1	G2	H	H1	H2	L	M	M1	Approx. Wt. (Lbs.)
801-202	1-1/2x1-1/4x1	7/8	1-7/32	7/8	2-1/4	2-11/32	2-1/4	4-1/2	2-7/16	1-13/16	.40
801-209	1-1/2x1-1/2x1/2	9/16	1-1/16	9/16	1-31/32	1-15/16	1-31/32	3-15/16	2-3/8	1-3/16	.32
801-210	1-1/2x1-1/2x3/4	11/16	1-1/32	11/16	2-1/16	2-1/32	2-1/16	4-5/32	2-11/32	1-13/32	.37
801-211	1-1/2x1-1/2x1	27/32	1-5/32	27/32	2-15/32	2-5/16	2-15/32	4-15/16	2-11/32	1-3/4	.42
801-212	1-1/2x1-1/2x1-1/4	1-3/16	1-3/16	1-3/16	2-9/16	2-7/16	2-9/16	5-1/8	2-3/8	2-1/8	.54
801-247	2x2x1/2	9/16	1-13/32	9/16	2-3/32	2-9/32	2-3/32	4-3/16	2-7/8	1-5/32	.44
801-248	2x2x3/4	11/16	1-13/32	11/16	2-3/16	2-13/32	2-3/16	4-3/8	2-27/32	1-13/32	.52
801-249	2x2x1	27/32	1-7/16	27/32	2-3/8	2-9/16	2-3/8	4-3/4	2-7/8	1-3/4	.58
801-250	2x2x1-1/4	31/32	1-11/32	31/32	2-17/32	2-19/32	2-17/32	5-3/32	2-7/8	2-1/8	.60
801-251	2x2x1-1/2	1-5/32	1-13/32	1-5/32	2-11/16	2-13/16	2-11/16	5-3/8	2-15/16	2-15/32	.77
801-254 ¹	2x2x4	3-11/16	2-15/32	3-11/16	5-3/16	4-23/32	5-3/16	10-11/32	5-1/4	5-1/4	5.61
801-287	2-1/2x2-1/2x1/2	19/32	1-19/32	19/32	2-3/8	2-15/32	2-3/8	4-23/32	3-1/2	1-3/16	.78
801-288	2-1/2x2-1/2x3/4	21/32	1-1/2	21/32	2-7/16	2-17/32	2-7/16	4-27/32	3-17/32	1-13/32	.83
801-289	2-1/2x2-1/2x1	27/32	1-23/32	27/32	2-5/8	2-27/32	2-5/8	5-1/4	3-17/32	1-23/32	.99
801-290	2-1/2x2-1/2x1-1/4	1-1/32	1-3/4	1-1/32	2-27/32	3	2-27/32	5-11/16	3-9/16	2-3/32	1.11
801-291	2-1/2x2-1/2x1-1/2	1-5/32	1-23/32	1-5/32	2-31/32	3-1/8	2-31/32	5-29/32	3-9/16	2-3/8	1.21
801-292	2-1/2x2-1/2x2	1-13/32	1-5/8	1-13/32	3-3/16	3-1/8	3-3/16	6-3/8	3-1/2	2-7/8	1.32
801-333 ¹	3x3x1/2	1-7/16	2-7/8	1-7/16	3-5/16	3-3/4	3-5/16	6-5/8	4-3/16	2-7/8	1.94
801-334 ¹	3x3x3/4	1-7/16	2-11/16	1-7/16	3-5/16	3-11/16	3-5/16	6-5/8	4-3/16	2-7/8	1.92
801-335	3x3x1	7/8	2	7/8	2-3/4	3-1/8	2-3/4	5-1/2	4-7/32	1-3/4	1.24
801-336 ¹	3x3x1-1/4	1-5/8	1-15/16	1-5/8	3-5/16	3-5/8	3-5/16	6-5/8	4-3/16	2-7/8	1.89
801-337	3x3x1-1/2	1-5/32	2-1/16	1-5/32	3-1/16	3-7/16	3-1/16	6-1/8	4-3/16	2-3/8	1.44
801-338	3x3x2	1-7/16	1-13/16	1-7/16	3-5/16	3-5/16	3-5/16	6-5/8	4-7/32	2-7/8	1.65
801-339	3x3x2-1/2	1-3/4	1-31/32	1-3/4	3-5/8	3-11/16	3-5/8	7-1/4	4-3/16	3-17/32	1.88
801-415 ¹	4x4x1/2	1-7/16	3-17/32	1-7/16	3-11/16	4-13/32	3-11/16	7-11/32	5-1/4	2-7/8	2.62
801-417 ¹	4x4x1	1-15/32	3-9/32	1-15/32	3-11/16	4-3/8	3-11/16	7-3/8	5-7/32	2-7/8	2.55
801-418 ¹	4x4x1-1/4	1-1/8	2-31/32	1-1/8	3-13/32	4-7/32	3-13/32	6-25/32	5-1/4	2-3/8	2.18
801-419	4x4x1-1/2	1-1/8	2-9/16	1-1/8	3-3/8	3-15/16	3-3/8	6-3/4	5-1/4	2-3/8	2.09
801-420	4x4x2	1-7/16	2-1/2	1-7/16	3-11/16	4	3-11/16	7-3/8	5-1/4	2-7/8	2.35
801-421 ¹	4x4x2-1/2	2-1/16	2-11/16	2-1/16	4-5/16	4-3/4	4-5/16	8-5/8	5-1/4	4-1/8	3.48
801-422	4x4x3	2-1/8	2-23/32	2-1/8	4-3/8	4-19/32	4-3/8	8-25/32	5-1/4	4-3/16	3.11
801-482F	5x5x1-1/4	4	4-11/16	4	7	6-3/16	7	14	6-5/16	2-1/16	5.99
801-484 ¹	5x5x1-1/2	3-5/32	5-17/32	3-5/32	5-13/16	6-29/32	5-13/16	11-5/8	6-13/32	6-13/32	8.86
801-484F	5x5x1-1/2	4-1/8	5	4-1/8	7-1/8	6-1/2	7-1/8	14-1/4	6-5/16	2-5/16	9.10
801-486 ¹	5x5x2	3-5/32	5-3/32	3-5/32	5-13/16	6-19/32	5-13/16	11-19/32	6-13/32	6-13/32	8.39
801-486F	5x5x2	4-5/16	4-3/4	4-5/16	7-5/16	6-1/2	7-5/16	14-5/8	6-5/16	2-13/16	6.87
801-487 ¹	5x5x2-1/2	3-5/32	4-23/32	3-5/32	5-13/16	6-15/32	5-13/16	11-5/8	6-13/32	6-13/32	8.28
801-488 ¹	5x5x3	3-5/32	4-5/8	3-5/32	5-13/16	6-1/2	5-13/16	11-19/32	6-13/32	6-13/32	8.21
801-490 ¹	5x5x4	3-5/32	3-29/32	3-5/32	5-13/16	6-5/32	5-13/16	11-5/8	6-13/32	6-13/32	7.40

¹ Outlet sized with bushing

Schedule 80 PVC Technical Information
Schedule 80 Fittings



REDUCING TEE (continued)

Socket x Socket x Socket

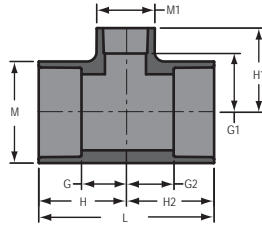

Part Number	Size	G	G1	G2	H	H1	H2	L	M	M1	Approx. Wt. (Lbs.)
801-523 ¹	6x6x1/2	1-7/16	4-13/16	1-7/16	4-7/16	5-11/16	4-7/16	8-7/8	7-19/32	2-7/8	.54
801-524 ¹	6x6x3/4	1	4	1	3-7/8	5	3-7/8	7-3/4	7-9/16	1-3/4	4.39
801-525	6x6x1	27/32	3-23/32	27/32	3-7/8	4-27/32	3-7/8	7-3/4	7-9/16	1-3/4	4.34
801-526 ¹	6x6x1-1/4	1-7/16	4-3/16	1-7/16	4-7/16	5-15/32	4-7/16	8-7/8	7-19/32	2-7/8	5.23
801-527 ¹	6x6x1-1/2	1-7/16	4-3/32	1-7/16	4-7/16	5-1/2	4-7/16	8-7/8	7-19/32	2-7/8	5.25
801-528	6x6x2	1-7/16	3-23/32	1-7/16	4-7/16	5-1/4	4-7/16	8-7/8	7-19/32	2-7/8	5.11
801-529 ¹	6x6x2-1/2	2-1/16	3-13/16	2-1/16	5-1/16	5-7/8	5-1/16	10-1/8	7-9/16	4-1/4	6.80
801-530	6x6x3	2-1/16	3-3/4	2-1/16	5-3/32	5-5/8	5-3/32	10-3/16	7-19/32	4-1/4	6.48
801-530F	6x6x3	4-3/4	5-3/4	4-3/4	8	8	8	16	7-1/2	4-1/8	12.33
801-532	6x6x4	2-11/16	3-23/32	2-11/16	5-11/16	5-31/32	5-11/16	11-13/32	7-19/32	5-1/4	7.69
801-533F	6x6x5	5-3/4	6-1/2	5-3/4	9	9-1/2	9	18	7-1/2	6-5/16	10.35
801-575 ¹	8x8x1	3-25/32	7-25/32	3-25/32	7-25/32	8-13/16	7-25/32	15-9/16	9-5/8	7-1/2	17.85
801-578 ¹	8x8x2	3-13/16	6-5/8	3-13/16	7-13/16	8-1/8	7-13/16	15-5/8	9-11/16	7-9/16	17.56
801-578F	8x8x2	4-11/16	6-1/8	4-11/16	8-15/16	7-7/8	8-15/16	17-7/8	9-5/8	2-13/16	12.89
801-579F	8x8x2-1/2	4-7/8	6-15/16	4-7/8	9-1/8	8-5/16	9-1/8	18-1/4	9-5/8	3-7/16	17.97
801-580 ¹	8x8x3	3-23/32	6-1/2	3-23/32	7-3/4	8-3/8	7-3/4	15-1/2	9-11/16	7-1/2	17.03
801-580F	8x8x3	5-3/16	6-11/16	5-3/16	9-7/16	8-15/16	9-7/16	18-7/8	9-5/8	4-1/8	17.42
801-582	8x8x4	2-5/8	4-27/32	2-5/8	6-5/8	7-3/32	6-5/8	13-1/4	9-3/4	5-9/32	11.56
801-582F	8x8x4	5-3/4	7-11/16	5-3/4	10	9-15/16	10	20	9-5/8	5-3/16	15.77
801-585	8x8x6	3-27/32	4-13/16	3-27/32	7-29/32	7-27/32	7-29/32	15-27/32	9-23/32	7-9/16	15.52
801-621F	10x10x2	4-3/8	7-1/8	4-3/8	9-5/8	8-7/8	9-5/8	19-1/4	11-15/16	2-13/16	21.56
801-622F	10x10x2-1/2	5-1/4	7-5/16	5-1/4	10-1/2	9-5/16	10-1/2	21	11-15/16	3-7/16	20.44
801-623 ¹	10x10x3	3-25/32	7-17/32	3-25/32	9-3/8	9-3/8	9-3/8	18-25/32	12-1/16	7-9/16	26.67
801-623F	10x10x3	4-7/8	7-11/16	4-7/8	10-1/8	9-15/16	10-1/8	20-1/4	11-15/16	4-1/8	20.67
801-624	10x10x4	3-7/8	7-3/16	3-7/8	9-3/8	9-1/2	9-3/8	18-3/4	12-1/16	7-9/16	26.36
801-624F	10x10x4	5-3/8	8-11/16	5-3/8	10-5/8	10-15/16	10-5/8	21-1/4	11-15/16	5-3/16	23.04
801-626	10x10x6	3-7/8	5-27/32	3-7/8	9-3/8	8-27/32	9-3/8	18-3/4	12-1/16	7-9/16	23.50
801-626F	10x10x6	5-7/8	9-1/16	5-7/8	11-1/8	12-5/16	11-1/8	22-1/4	11-15/16	7-1/2	34.74
801-628 ¹	10x10x8	5-15/16	7-3/4	5-15/16	11-7/16	11-3/4	11-7/16	22-7/8	12-1/16	12-1/16	43.06
801-628F	10x10x8	8-1/4	9-15/16	8-1/4	13-1/2	14-3/16	13-1/2	27	11-15/16	9-5/8	34.59
801-661F	12x12x2	4-3/4	8	4-3/4	11	9-3/4	11	22	14-1/8	2-13/16	29.04
801-662F	12x12x2-1/2	5-7/16	8-3/16	5-7/16	11-11/16	10-3/16	11-11/16	23-3/8	14-1/8	3-7/16	37.84
801-663F	12x12x3	5-1/4	8-9/16	5-1/4	11-1/2	10-13/16	11-1/2	23	14-1/8	4-1/8	32.26
801-664 ¹	12x12x4	4-11/32	10-1/8	4-11/32	10-15/16	12-3/8	10-15/16	21-7/8	14-1/4	9-23/32	32.86
801-664F	12x12x4	5-3/4	9-9/16	5-3/4	12	11-13/16	12	24	14-1/8	5-3/16	32.86
801-665F	12x12x5	7-1/8	9-5/16	7-1/8	13-3/8	12-5/16	13-3/8	26-3/4	14-1/8	6-5/16	47.29
801-666F	12x12x6	7-1/4	9-15/16	7-1/4	13-1/4	13-3/16	13-1/4	26-1/2	14-1/8	7-1/2	45.37
801-668	12x12x8	4-27/32	7-1/2	4-27/32	11-13/32	11-1/8	11-13/32	22-13/16	14-1/4	9-23/32	40.00
801-668F	12x12x8	8	10-13/16	8	14-1/4	15-1/16	14-1/4	28-1/2	14-1/8	9-5/8	57.91
801-670F	12x12x10	10-1/4	10-13/16	10-1/4	16-1/2	16-1/16	16-1/2	33	14-1/8	11-15/16	67.18
801-691F	14x14x2	5-3/16	8-9/16	5-3/16	12-3/16	10-5/16	12-3/16	24-3/8	15-1/2	2-13/16	38.66

¹ Outlet sized with bushing





Schedule 80 PVC Technical Information
Schedule 80 Fittings

REDUCING TEE (continued)

Socket x Socket x Socket

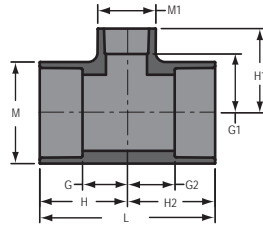

Part Number	Size	G	G1	G2	H	H1	H2	L	M	M1	Approx. Wt. (Lbs.)
801-692F	14x14x2-1/2	5-7/16	8-3/4	5-7/16	12-7/16	10-3/4	12-7/16	24-7/8	15-1/2	3-7/16	44.34
801-693F	14x14x3	5-3/4	9-1/8	5-3/4	12-3/4	11-3/8	12-3/4	25-1/2	15-1/2	4-1/8	40.35
801-694F	14x14x4	6-1/2	10-1/8	6-1/2	13-1/2	12-3/8	13-1/2	27	15-1/2	5-3/16	41.85
801-696F	14x14x6	8-1/4	10-1/2	8-1/4	15-1/4	13-3/4	15-1/4	30-1/2	15-1/2	7-1/2	63.15
801-698F	14x14x8	9-1/4	11-3/8	9-1/4	16-1/4	15-5/8	16-1/4	32-1/2	15-1/2	9-5/8	74.74
801-700F	14x14x10	10-1/8	11-3/8	10-1/8	17-1/8	16-5/8	17-1/8	34-1/4	15-1/2	11-15/16	79.05
801-702	14x14x12	7-1/32	7-13/32	7-1/32	14-1/32	13-13/32	14-1/32	28-1/16	15-21/32	14-11/32	61.20
801-702F	14x14x12	11	11-3/8	11	18	17-5/8	18	36	15-1/2	14-1/8	93.81
801-751F	16x16x2	5-7/8	9-1/2	5-7/8	13-7/8	11-1/4	13-7/8	27-3/4	17-11/16	2-13/16	62.38
801-752F	16x16x2-1/2	6	9-11/16	6	14	11-11/16	14	28	17-11/16	3-7/16	55.65
801-753F	16x16x3	6-5/16	10-1/16	6-5/16	14-5/16	12-5/16	14-5/16	28-5/8	17-11/16	4-1/8	56.70
801-754F	16x16x4	6-1/8	11-1/16	6-1/8	14-1/8	13-5/16	14-1/8	28-1/4	17-11/16	5-3/16	60.66
801-756F	16x16x6	8-5/8	11-7/16	8-5/8	16-5/8	14-11/16	16-5/8	33-1/4	17-11/16	7-1/2	85.07
801-758F	16x16x8	9-5/8	12-5/16	9-5/8	17-5/8	16-9/16	17-5/8	35-1/4	17-11/16	9-5/8	94.91
801-760F	16x16x10	10-5/8	12-5/16	10-5/8	18-5/8	17-9/16	18-5/8	37-1/4	17-11/16	11-15/16	103.85
801-762F	16x16x12	11-5/8	12-5/16	11-5/8	19-5/8	18-9/16	19-5/8	39-1/4	17-11/16	14-1/8	116.70
801-764F	16x16x14	12-3/4	12-11/16	12-3/4	20-3/4	19-11/16	20-3/4	41-1/2	17-11/16	15-1/2	129.51
801-784F	18x18x4	6-7/8	11-15/16	6-7/8	15-7/8	14-3/16	15-7/8	31-3/4	19-7/8	5-3/16	91.52
801-786F	18x18x6	8-1/2	12-5/16	8-1/2	17-1/2	15-9/16	17-1/2	35	19-7/8	7-1/2	115.09
801-788F	18x18x8	9-1/2	13-3/16	9-1/2	18-1/2	17-7/16	18-1/2	37	19-7/8	9-5/8	118.85
801-790F	18x18x10	10-1/2	13-3/16	10-1/2	19-1/2	18-7/16	19-1/2	39	19-7/8	11-15/16	128.48
801-792F	18x18x12	11-1/2	13-3/16	11-1/2	20-1/2	19-7/16	20-1/2	41	19-7/8	14-1/8	151.17
801-794F	18x18x14	12-3/4	13-9/16	12-3/4	21-3/4	20-9/16	21-3/4	43-1/2	19-11/16	15-1/2	151.23
801-796F	18x18x16	13-1/2	14-3/16	13-1/2	22-1/2	22-3/16	22-1/2	45	19-11/16	17-11/16	140.86
801-814F	20x20x4	7-11/16	12-7/8	7-11/16	17-11/16	15-1/8	17-11/16	35-3/8	22-1/16	5-3/16	114.37
801-816F	20x20x6	8-7/8	13-1/4	8-7/8	18-7/8	16-1/2	18-7/8	37-3/4	22-1/16	7-1/2	130.08
801-818F	20x20x8	9-7/8	14-1/8	9-7/8	19-7/8	18-3/8	19-7/8	39-3/4	22-1/16	9-5/8	137.63
801-820F	20x20x10	10-7/8	14-1/8	10-7/8	20-7/8	19-3/8	20-7/8	41-3/4	22-1/16	11-15/16	123.96
801-822F	20x20x12	11-7/8	14-1/8	11-7/8	21-7/8	20-3/8	21-7/8	43-3/4	22-1/16	14-1/8	164.33
801-824F	20x20x14	12-7/8	14-1/2	12-7/8	22-7/8	21-1/2	22-7/8	45-3/4	22-1/16	15-1/2	176.28
801-826F	20x20x16	14	15-1/8	14	24	23-1/8	24	48	22-1/16	17-11/16	191.64
801-828F	20x20x18	15	15	15	25	24	25	50	22-1/16	19-7/8	215.72
801-904F	24x24x4	9	14-11/16	9	21	16-15/16	21	42	26-7/16	5-3/16	191.09
801-906F	24x24x6	9-1/4	15-1/16	9-1/4	21-1/4	18-5/16	21-1/4	42-1/2	26-7/16	7-1/2	207.79
801-908F	24x24x8	10-1/4	15-15/16	10-1/4	22-1/4	20-3/16	22-1/4	44-1/2	26-7/16	9-5/8	215.05
801-910F	24x24x10	11-1/4	15-15/16	11-1/4	23-1/4	21-3/16	23-1/4	46-1/2	26-7/16	11-15/16	248.46
801-912F	24x24x12	12-1/4	15-15/16	12-1/4	24-1/4	22-3/16	24-1/4	48-1/2	26-7/16	14-1/8	290.75
801-914F	24x24x14	13-1/4	16-5/16	13-1/4	25-1/4	23-5/16	25-1/4	50-1/2	26-1/16	15-1/2	279.60
801-916F	24x24x16	14-3/4	16-15/16	14-3/4	26-3/4	24-15/16	26-3/4	53-1/2	26-7/16	17-11/16	297.80
801-918F	24x24x18	15-3/4	16-13/16	15-3/4	27-3/4	25-13/16	27-3/4	55-1/2	26-7/16	19-7/8	303.81
801-920F	24x24x20	16-3/4	18-3/16	16-3/4	28-3/4	28-3/16	28-3/4	57-1/2	26-7/16	22-1/16	341.61

Schedule 80 PVC Technical Information
Schedule 80 Fittings



TEE

Socket x Socket x Fipt

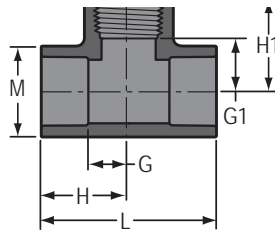

Part Number	Size	G	G1	H	H1	L	M	Approx. Wt. (Lbs.)
802-002	1/4	5/16	3/8	15/16	15/16	1-29/32	7/8	.05
802-005	1/2	19/32	21/32	1-15/32	1-11/32	2-15/16	1-3/16	.14
802-007	3/4	5/8	5/8	1-19/32	1-13/32	3-3/16	1-13/32	.14
802-010	1	11/16	3/4	1-13/16	1-5/8	3-13/16	1-13/16	.23
802-012	1-1/4	13/16	1-1/16	2-3/32	1-15/16	4-5/32	2-3/32	.34
802-015	1-1/2	29/32	1-1/4	2-11/32	2-5/32	4-11/16	2-3/8	.49
802-020	2	1-9/32	1-15/32	2-13/16	2-13/32	5-21/32	2-7/8	.77
802-030	3	1-31/32	2-1/8	3-3/4	3-17/32	7-15/32	4-5/16	2.31
802-040	4	2-11/32	2-21/32	4-5/8	4-5/32	9-7/32	5-9/32	3.37
802-060F	6	3-13/16	8-1/4	6-13/16	9-3/4	13-5/8	7-9/16	14.19
802-080F	8	4-13/16	10-13/16	8-13/16	12-9/16	17-11/16	9-11/16	25.92



REDUCING TEE

Socket x Socket x Fipt

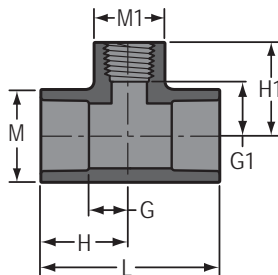

Part Number	Size	G	G1	H	H1	L	M	M1	Approx. Wt. (Lbs.)
802-101	3/4x3/4x1/2	19/32	25/32	1-19/32	1-7/16	3-7/32	1-13/32	1-3/16	.14
802-130	1x1x1/2	7/16	29/32	1-9/16	1-5/8	3-1/8	1-23/32	1-7/16	.18
802-131	1x1x3/4	21/32	13/16	1-13/16	1-17/32	3-5/8	1-23/32	1-3/8	.21
802-166	1-1/4x1-1/4x1/2	7/16	1-1/8	1-11/16	1-27/32	3-3/8	2-3/32	1-3/16	.26
802-167 ¹	1-1/4x1-1/4x3/4	7/8	1-23/32	2-1/8	2-7/16	4-7/32	2-3/32	1-3/4	.40
802-168	1-1/4x1-1/4x1	27/32	1-1/32	2-3/32	1-29/32	4-7/32	2-3/32	1-11/16	.33
802-209 ¹	1-1/2x1-1/2x1/2	11/16	1-9/16	2-3/32	2-9/32	4-5/32	2-11/32	1-13/32	.40
802-210 ¹	1-1/2x1-1/2x3/4	7/8	1-27/32	2-1/4	2-19/32	4-1/2	2-3/8	1-11/16	.51
802-211	1-1/2x1-1/2x1	27/32	1-9/32	2-1/4	2-3/32	4-15/32	2-3/8	1-11/16	.41
802-212	1-1/2x1-1/2x1-1/4	1-1/32	1-5/32	2-7/16	2-3/32	4-27/32	2-3/8	2-1/16	.47
802-247 ¹	2x2x1/2	1/2	1-1/2	2	2-7/32	4	2-7/8	1-3/16	.45
802-248	2x2x3/4	5/8	1-3/8	2-1/8	2-3/32	4-1/4	2-7/8	1-3/8	.47

¹ Outlet sized with bushing



Schedule 80 PVC Technical Information
Schedule 80 Fittings

REDUCING TEE (continued)

Socket x Socket x Fipt

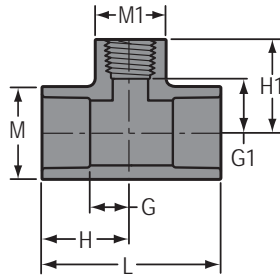

Part Number	Size	G	G1	H	H1	L	M	M1	Approx. Wt. (Lbs.)
802-249	2x2x1	27/32	1-1/2	2-11/32	3-11/32	4-11/16	2-7/8	1-11/16	.54
802-250 ¹	2x2x1-1/4	1-3/16	2-1/16	2-11/16	3	5-3/8	2-7/8	2-13/32	.86
802-251 ¹	2x2x1-1/2	1-7/16	2-5/16	2-15/16	3-11/32	5-7/8	2-7/8	2-7/8	1.20
802-287	2-1/2x2-1/2x1/2	9/16	1-25/32	2-5/16	2-15/32	4-19/32	3-1/2	1-3/16	.76
802-288 ¹	2-1/2x2-1/2x3/4	27/32	2-11/32	2-21/32	3-5/32	5-9/32	3-9/16	1-13/16	1.06
802-289 ¹	2-1/2x2-1/2x1	1-3/32	2-11/32	2-27/32	3-1/4	5-11/16	3-1/2	2-1/8	1.19
802-290 ¹	2-1/2x2-1/2x1-1/4	1-3/16	2-15/32	2-31/32	3-15/32	5-15/16	3-1/2	2-3/8	1.30
802-291 ¹	2-1/2x2-1/2x1-1/2	1-7/16	2-1/2	3-3/16	3-1/2	6-3/8	3-1/2	2-7/8	1.51
802-292 ¹	2-1/2x2-1/2x2	1-3/4	3-15/16	3-1/2	2-7/8	7	3-15/32	3-15/32	1.86
802-333 ¹	3x3x1/2	7/8	2-11/16	2-3/4	3-7/16	5-1/2	4-1/8	1-23/32	1.27
802-334 ¹	3x3x3/4	7/8	2-19/32	2-3/4	3-11/32	5-1/2	4-3/16	1-3/4	1.26
802-335 ¹	3x3x1	1-3/16	2-31/32	3-1/16	3-7/8	6-1/8	4-1/8	2-11/32	1.53
802-337 ¹	3x3x1-1/2	1-7/16	2-23/32	3-5/16	3-23/32	6-5/8	4-1/4	2-29/32	1.84
802-338 ¹	3x3x2	2-3/32	3-11/32	3-31/32	4-3/8	7-15/16	4-5/32	4-5/32	3.03
802-339 ¹	3x3x2-1/2	2-3/32	2-3/4	3-31/32	4-5/16	7-15/16	4-1/8	4-1/8	2.90
802-415 ¹	4x4x1/2	1-7/16	3-5/8	3-11/16	4-3/8	7-3/8	5-1/4	2-7/8	2.61
802-416 ¹	4x4x3/4	1-15/32	3-27/32	3-23/32	4-17/32	7-7/16	5-1/4	2-7/8	2.72
802-417 ¹	4x4x1	1-7/16	3-17/32	3-23/32	4-13/32	7-13/32	5-1/4	2-7/8	2.73
802-419 ¹	4x4x1-1/2	3-11/16	3-1/2	3-11/16	3-31/32	7-3/8	5-1/4	2-7/8	2.63
802-420 ¹	4x4x2	2-1/8	4-1/32	4-3/8	5-1/32	8-25/32	5-1/4	4-3/16	3.77
802-421 ¹	4x4x2-1/2	2-1/8	3-15/32	4-3/8	5	8-25/32	5-1/4	4-3/16	3.62
802-422 ¹	4x4x3	2-5/8	3-5/8	4-7/8	5-1/4	9-3/4	5-1/4	5-1/4	5.13
802-525 ¹	6x6x1	2-1/16	5-3/16	5-3/32	6-1/16	10-5/32	7-19/32	4-1/4	7.11
802-528F	6x6x2	4-5/8	5-1/8	7-7/8	6-9/16	15-3/4	7-1/2	3	11.01
802-529 ¹	6x6x2-1/2	2-1/16	4-21/32	5-3/32	6-3/16	10-5/32	7-19/32	4-1/4	6.97
802-530 ¹	6x6x3	2-11/16	4-3/4	5-9/16	6-3/8	11-1/8	7-1/2	5-1/4	13.79
802-532F	6x6x4	5-1/4	6-3/4	8-1/2	8-1/4	17	7-1/2	5-3/16	13.77
802-578F	8x8x2	4-11/16	6-1/16	8-15/16	7-1/2	17-7/8	9-5/8	3	15.46
802-580F	8x8x3	5-3/16	7	9-7/16	8-7/16	18-7/8	9-5/8	4-1/8	18.24
802-582F	8x8x4	5-3/4	7-11/16	10	9-1/8	20	9-5/8	5-3/16	17.71
802-621F	10x10x2	4-3/8	7-9/16	9-5/8	8-15/16	19-1/4	11-15/16	3	26.78
802-623F	10x10x3	4-7/8	8-3/16	10-1/8	9-5/8	20-1/4	11-15/16	4-1/8	31.67
802-624F	10x10x4	5-3/8	8-13/16	10-5/8	10-5/16	21-1/4	11-15/16	5-3/16	32.18
802-661F	12x12x2	4-3/4	8-7/16	11	9-13/16	22	14-1/8	3	37.80
802-663F	12x12x3	5-1/4	9-1/4	11-1/2	10-11/16	23	14-1/8	4-1/8	36.19
802-664F	12x12x4	5-3/4	9-15/16	12	11-7/16	24	14-1/8	5-3/16	47.80

¹ Outlet sized with bushing

Schedule 80 PVC Technical Information
Schedule 80 Fittings



REDUCING TEE

Socket x Fipt x Socket

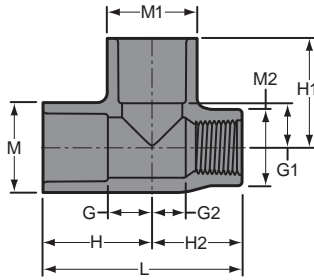

Part Number	Size	G	G1	G2	H	H1	H2	L	M	M1	M2	Approx. Wt. (Lbs.)
803-095	3/4x1/2x3/4	11/16	11/16	11/16	1-11/16	1-11/16	1-3/8	3-3/32	1-13/32	1-13/32	1-3/16	.15

SPECIAL REINFORCED REDUCING TEE

Socket x SR Fipt x Socket

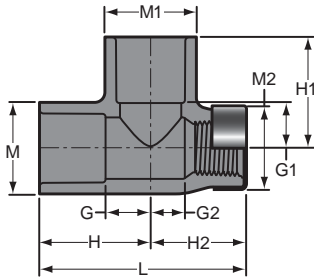

Part Number	Size	G	G1	G2	H	H1	H2	L	M	M1	M2	Approx. Wt. (Lbs.)
803-095SR	3/4x1/2x3/4	11/16	11/16	11/16	1-11/16	1-11/16	1-13/32	3-1/8	1-13/32	1-13/32	1-7/32	.15

TEE

Socket x Socket x Brass Fipt

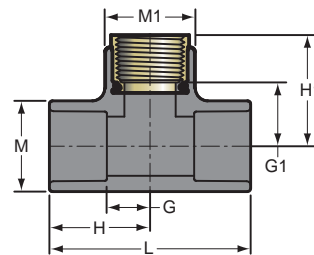

Part Number	Size	G	G1	H	H1	L	M	M1	Approx. Wt. (Lbs.)
802-005BR	1/2	7/8	31/32	1-7/16	1-17/32	2-5/8	1-5/32	1-7/32	.16
802-007BR	3/4	17/32	1-3/32	1-13/32	1-13/16	3-1/32	1-13/32	1-3/8	.25

Not intended to convey or dispense water for human consumption through drinking or cooking



Schedule 80 PVC Technical Information
Schedule 80 Fittings

REDUCING TEE

Socket x Socket x Brass Fipt

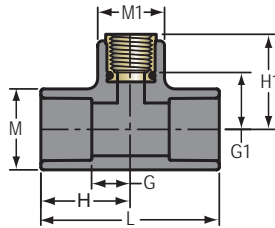

Part Number	Size	G	G1	H	H1	L	M	M1	Approx. Wt. (Lbs.)
802-072BR	1/2x1/2x1/4	7/16	7/8	1-5/16	1-17/32	2-5/8	1-3/16	1-3/16	.22
802-101BR	3/4x3/4x1/2	7/16	1-1/32	1-7/16	1-5/8	2-29/32	1-13/32	1-3/16	.19

Not intended to convey or dispense water for human consumption through drinking or cooking

SPECIAL REINFORCED TEE

Socket x Socket x SR Fipt

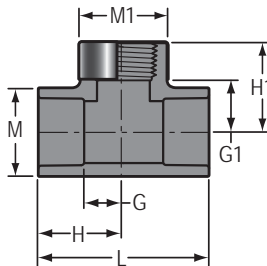

Part Number	Size	G	G1	H	H1	L	M	M1	Approx. Wt. (Lbs.)
802-005SR	1/2	5/8	5/8	1-15/32	1-3/8	2-15/16	1-7/32	1-13/32	.13
802-007SR	3/4	19/32	11/16	1-19/32	1-13/32	3-3/16	1-13/32	1-13/32	.15
802-010SR	1	21/32	11/16	1-13/16	1-5/8	3-5/8	1-23/32	1-11/16	.25
802-012SR	1-1/4	13/16	1-1/16	2-3/32	1-15/16	4-3/16	2-3/32	2-1/16	.37
802-015SR	1-1/2	15/16	1-7/32	2-11/32	2-5/32	4-11/16	2-11/32	2-7/16	.51
802-020SR	2	1-5/16	1-1/2	2-13/16	2-13/32	5-21/32	2-7/8	3-1/32	.80
802-030SR	3	1-27/32	2-3/32	3-23/32	3-17/32	7-7/16	4-9/32	4-9/32	2.33
802-040SR	4	2-11/32	2-21/32	4-5/8	4-5/32	9-7/32	5-1/4	5-1/4	3.40

Schedule 80 PVC Technical Information
Schedule 80 Fittings



SPECIAL REINFORCED REDUCING TEE

Socket x Socket x SR Fipt

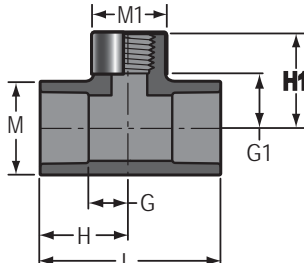

Part Number	Size	G	G1	H	H1	L	M	M1	Approx. Wt. (Lbs.)
802-072SR	1/2x1/2x1/4	7/16	11/16	1-5/16	1-7/32	2-5/8	1-5/32	27/32	.09
802-098SR	3/4x3/4x1/4	7/16	13/16	1-7/16	1-5/16	2-7/8	1-3/8	27/32	.12
802-101SR	3/4x3/4x1/2	19/32	25/32	1-19/32	1-7/16	3-7/32	1-13/32	1-3/16	.15
802-128SR ¹	1x1x1/4	7/8	2-5/8	2	2-11/16	4	2-3/32	27/32	.43
802-130SR	1x1x1/2	7/16	29/32	1-9/16	1-5/8	3-1/8	1-23/32	1-3/16	.19
802-131SR	1x1x3/4	21/32	7/8	1-13/16	1-19/32	3-19/32	1-23/32	1-3/8	.22
802-164SR ¹	1-1/4x1-1/4x1/4	27/32	2-13/16	2-1/8	3-13/32	4-7/32	2-3/32	27/32	.43
802-166SR	1-1/4x1-1/4x1/2	7/16	1-1/8	1-11/16	1-27/32	3-13/32	2-3/32	1-3/16	.26
802-168SR	1-1/4x1-1/4x1	27/32	1-1/32	2-3/32	1-29/32	4-7/32	2-3/32	1-11/16	.35
802-207SR ¹	1-1/2x1-1/2x1/4	27/32	1-31/32	2-1/4	2-19/32	4-15/32	2-11/32	1-3/4	.49
802-211SR	1-1/2x1-1/2x1	27/32	1-7/32	2-1/4	2-1/8	4-15/32	2-3/8	1-11/16	.42
802-212SR	1-1/2x1-1/2x1-1/4	1-1/32	1-5/32	2-7/16	2-3/32	4-27/32	2-3/8	2-1/16	.49
802-247SR	2x2x1/2	1/2	1-1/2	2	2-1/4	4	2-7/8	1-3/16	.45
802-248SR	2x2x3/4	19/32	1-13/32	2-1/8	2-1/8	4-1/4	2-7/8	1-3/8	.48
802-287SR	2-1/2x2-1/2x1/2	9/16	1-3/4	2-5/16	2-1/2	4-19/32	3-1/2	1-7/32	.75
802-331SR ¹	3x3x1/4	1-13/32	4-1/2	3-5/16	5-1/32	6-9/16	4-3/16	27/32	1.90
802-413SR ¹	4x4x1/4	1-7/16	5-3/16	3-11/16	5-25/32	7-3/8	5-1/4	27/32	2.63

¹Outlet sized with bushing

TEE

Fipt x Fipt x Fipt

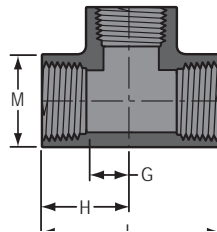

Part Number	Size	G	H	L	M	Approx. Wt. (Lbs.)
805-002	1/4	1/2	1-3/32	2-3/16	27/32	.06
805-003	3/8	9/16	1-5/32	2-5/16	15/16	.07
805-005	1/2	17/32	1-1/4	2-15/32	1-3/16	.11
805-007	3/4	21/32	1-15/32	2-15/16	1-1/2	.19
805-010	1	3/4	1-23/32	3-7/16	1-27/32	.34
805-012	1-1/4	15/16	1-31/32	3-29/32	2-1/4	.47
805-015	1-1/2	1-1/8	2-3/16	4-3/8	2-13/32	.60
805-020	2	1-5/8	2-5/8	5-1/4	3	1.08
805-025	2-1/2	1-9/16	3-1/8	6-1/4	3-19/32	1.65
805-030	3	1-15/16	3-9/16	7-3/32	4-11/32	2.82
805-040	4	2-1/2	4-7/32	8-7/16	5-7/16	4.37
805-060F	6	8-1/4	9-3/4	19-1/2	7-3/16	20.11



Schedule 80 Fittings

SPECIAL REINFORCED TEE

SR Fipt x SR Fipt x SR Fipt

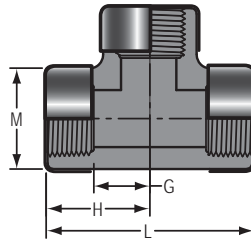

Part Number	Size	G	H	L	M	Approx. Wt. (Lbs.)
805-002SR	1/4	17/32	1-1/8	2-1/4	27/32	.08
805-003SR	3/8	19/32	1-3/16	2-11/32	31/32	.09
805-005SR	1/2	1/2	1-1/4	2-1/2	1-3/16	.14
805-007SR	3/4	19/32	1-11/32	2-11/16	1-3/8	.16
805-010SR	1	7/8	1-25/32	3-9/16	1-11/16	.32
805-015SR	1-1/2	1-1/4	2-3/16	4-13/32	2-13/32	.66
805-020SR	2	1-5/8	2-5/8	5-1/4	3	1.17

STREET TEE

Spigot x Socket x Socket

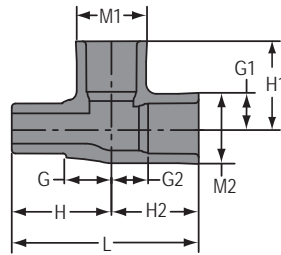

Part Number	Size	G	G1	G2	H	H1	H2	L	M1	M2	Approx. Wt. (Lbs.)
844-005	1/2	23/32	23/32	1/2	1-19/32	1-21/32	1-19/32	3-5/32	1-3/16	1-3/16	.10
844-007	3/4	13/16	27/32	7/8	1-13/16	1-7/8	1-13/16	3-5/8	1-13/32	1-13/32	.15
844-010	1	1-3/32	13/16	13/16	2-7/32	2	2	4-7/32	1-3/4	1-3/4	.26
844-012	1-1/4	1-1/4	1-5/32	1-1/8	2-7/16	2-5/16	2-7/16	4-7/8	2-3/32	2-3/32	.39
844-015	1-1/2	1-13/16	1-1/8	1-1/8	2-7/8	2-9/16	2-9/16	5-11/32	2-11/32	2-11/32	.51
844-020	2	1-23/32	1-7/16	1-13/32	3-1/4	2-15/16	2-15/16	6-5/32	2-7/8	2-7/8	.80

Schedule 80 PVC Technical Information
Schedule 80 Fittings



90° ELBOW

Socket x Socket

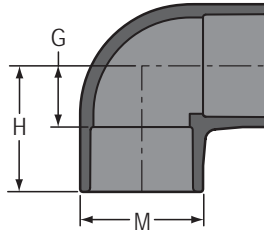

Part Number	Size	G	H	M	Approx. Wt. (Lbs.)
806-002	1/4	11/32	1	13/16	.03
806-003	3/8	15/32	1-1/4	31/32	.05
806-005	1/2	9/16	1-15/32	1-3/16	.08
806-007	3/4	5/8	1-11/16	1-7/16	.12
806-010	1	7/8	2	1-3/4	.20
806-012	1-1/4	1-1/32	2-9/32	2-1/8	.30
806-015	1-1/2	1-5/32	1-9/16	2-3/8	.39
806-020	2	1-13/32	2-15/16	2-7/8	.60
806-025	2-1/2	1-9/16	3-11/32	3-15/32	1.09
806-030	3	2-1/16	3-31/32	4-3/16	1.60
806-040	4	2-5/8	4-7/8	5-7/32	2.78
806-045F	4-1/2	6-1/2	9	5-5/8	4.58
806-050	5	3	5-3/4	6-3/8	4.42
806-050F	5	5-1/2	8-1/2	6-5/16	6.23
806-060	6	3-3/4	6-3/4	7-19/32	7.47
806-080	8	4-25/32	8-25/32	9-3/4	14.30
806-080F	8	7-7/8	12-1/8	9-5/8	17.47
806-100	10	5-25/32	10-13/16	12-5/32	26.34
806-100F	10	10	15-1/4	11-15/16	31.86
806-120	12	6-7/8	13-7/16	14-5/16	43.94
806-120F	12	11-1/2	17-3/4	14-1/8	60.28
806-140	14	7-1/2	14-1/2	15-11/16	53.05
806-140F	14	13-1/2	20-1/2	15-1/2	82.49
806-160F	16	15-9/16	23-9/16	17-11/16	101.71
806-180F	18	17-11/16	26-11/16	19-7/8	167.49
806-200F	20	19-13/16	29-13/16	22-1/16	193.41
806-240F	24	24	36	26-7/16	403.66





Schedule 80 PVC Technical Information
Schedule 80 Fittings

90° SWEEP ELBOW

Socket x Socket

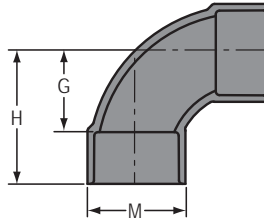

Part Number	Size	G	H	M	Approx. Wt. (Lbs.)
806-005S	1/2	27/32	1-23/32	1-3/16	.08
806-007S	3/4	1-1/32	2-1/32	1-13/32	.12
806-010S	1	1-5/16	2-7/16	1-23/32	.20
806-012S	1-1/4	1-9/16	2-13/16	2-3/32	.30
806-015S	1-1/2	1-3/4	3-1/8	2-11/32	.39
806-020S	2	2-5/16	3-13/16	2-7/8	.64

90° LONG SWEEP ELBOW

Socket x Socket

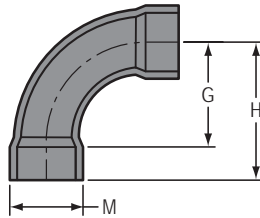

Part Number	Size	G	H	M	Approx. Wt. (Lbs.)
806-005LSF	1/2	1-7/8	2-3/4	1-1/8	.13
806-007LSF	3/4	2-7/16	3-7/16	1-7/16	.22
806-010LSF	1	2-7/8	4	1-11/16	.33
806-012LSF	1-1/4	3-5/8	4-7/8	2-1/16	.50
806-015LSF	1-1/2	4-1/8	5-1/2	2-5/16	.60
806-020LSF	2	4-3/4	6-5/16	2-13/16	.90
806-025LSF	2-1/2	5-3/4	7-3/4	3-7/16	1.65
806-030LSF	3	7	9	4-1/8	2.36
806-040LSF	4	9	11-1/4	5-3/16	4.76
806-060LSF	6	13	16-1/4	7-1/2	12.84
806-080LSF	8	23-1/2	27-3/4	9-5/8	31.58

Schedule 80 PVC Technical Information
Schedule 80 Fittings



90° ELBOW

Socket x Fipt

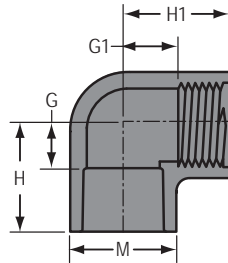

Part Number	Size	G	G1	H	H1	M	Approx. Wt. (Lbs.)
807-002	1/4	5/16	5/16	15/16	15/16	7/8	.03
807-003	3/8	1/4	3/8	1-1/32	1-1/32	1-1/32	.05
807-005	1/2	15/32	9/16	1-11/32	1-9/32	1-3/16	.08
807-007	3/4	5/8	5/8	1-9/16	1-9/16	1-3/8	.09
807-010	1	11/16	25/32	1-13/16	1-11/16	1-23/32	.19
807-012	1-1/4	23/32	1-1/32	1-31/32	1-31/32	2-1/16	.28
807-015	1-1/2	15/16	1-7/32	2-11/32	2-5/32	2-11/32	.39
807-020	2	15/16	1-1/32	2-7/16	2	3	.80
807-030	3	1-27/32	2-7/32	3-23/32	3-9/16	4-9/32	1.72
807-040	4	2-5/16	2-7/8	4-9/16	4-9/32	5-1/4	2.87
807-060 ¹	6	3-3/4	7-1/8	6-3/4	8-7/8	7-9/16	11.48

¹ Outlet sized with Female Adapter



90° REDUCING ELBOW

Socket x Fipt

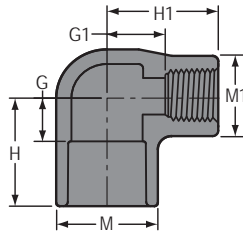

Part Number	Size	G	G1	H	H1	M	M1	Approx. Wt. (Lbs.)
807-101	3/4x1/2	1/2	25/32	1-17/32	1-17/32	1-13/32	1-3/16	.11
807-130 ¹	1x1/2	27/32	1-17/32	1-31/32	2-1/4	1-23/32	1-23/32	.26
807-131 ¹	1x3/4	7/8	1-17/32	2	2-1/4	1-3/4	1-3/4	.25

¹ Outlet sized with Female Adapter



Schedule 80 PVC Technical Information
Schedule 80 Fittings

SPECIAL REINFORCED 90° ELBOW

Socket x SR Fipt

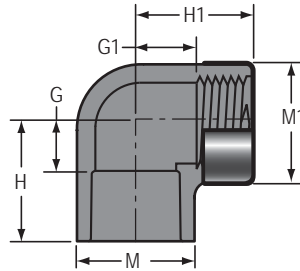

Part Number	Size	G	G1	H	H1	M	M1	Approx. Wt. (Lbs.)
807-005SR	1/2	15/32	23/32	1-11/32	1-9/32	1-3/16	1-7/32	.08
807-007SR	3/4	9/16	21/32	1-9/16	1-13/32	1-3/8	1-3/8	.11
807-010SR	1	19/32	13/16	1-23/32	1-23/32	1-11/16	1-23/32	.20
807-012SR	1-1/4	23/32	1-1/32	1-31/32	1-31/32	2-1/16	2-1/16	.30
807-015SR	1-1/2	31/32	1-5/32	2-3/8	2-1/8	2-11/32	2-7/16	.41
807-020SR	2	1-7/32	1-1/2	2-15/32	2-7/16	2-31/32	2-31/32	.83
807-030SR	3	1-13/16	2-7/32	3-23/32	3-9/16	4-9/32	4-9/32	1.98
807-040SR	4	2-9/32	2-25/32	4-9/16	4-7/32	5-1/4	5-1/4	2.94

SPECIAL REINFORCED REDUCING 90° ELBOW

Socket x SR Fipt

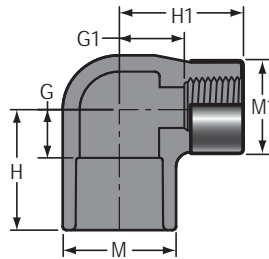

Part Number	Size	G	G1	H	H1	M	M1	Approx. Wt. (Lbs.)
807-101SR	3/4x1/2	1/2	13/16	1-17/32	1-17/32	1-13/32	1-3/16	.12
807-130SR	1x1/2	9/16	1	1-23/32	1-5/8	1-23/32	1-3/16	.13

TRANSITION 90° ELBOW

Socket x Brass Fipt

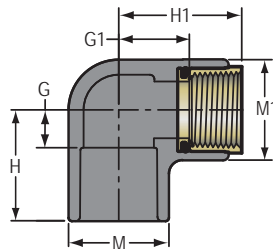

Part Number	Size	G	G1	H	H1	M	M1	Approx. Wt. (Lbs.)
807-005BR	1/2	13/32	31/32	1-9/32	1-17/32	1-3/16	1-7/32	.15
807-007BR	3/4	1/2	1-5/32	1-1/2	1-25/32	1-3/8	1-13/32	.20

Not intended to convey or dispense water for human consumption through drinking or cooking

Schedule 80 PVC Technical Information
Schedule 80 Fittings



TRANSITION REDUCING

90° ELBOW

Socket x Brass Fipt

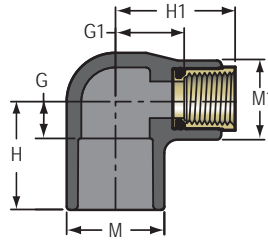

Part Number	Size	G	G1	H	H1	M	M1	Approx. Wt. (Lbs.)
807-101BR	3/4x1/2	15/32	1-3/32	1-15/32	1-21/32	1-13/32	1-3/16	.17

Not intended to convey or dispense water for human consumption through drinking or cooking

90° ELBOW

Fipt x Fipt

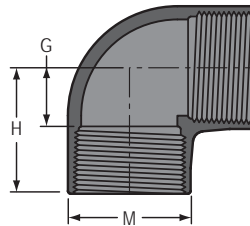

Part Number	Size	G	H	M	Approx. Wt. (Lbs.)
808-002	1/4	11/32	15/16	7/8	.04
808-003	3/8	9/16	1-5/32	15/16	.05
808-005	1/2	1/2	1-7/32	1-9/32	.09
808-007	3/4	5/8	1-3/8	1-3/8	.11
808-010	1	25/32	1-5/8	1-23/32	.20
808-012	1-1/4	15/16	1-7/8	2-1/16	.30
808-015	1-1/2	1-5/32	2-3/32	2-7/16	.46
808-020	2	1-9/16	2-17/32	3	.86
808-025	2-1/2	1-5/8	3-3/16	3-9/16	1.20
808-030	3	1-29/32	3-17/32	4-13/32	2.30
808-040	4	2-15/32	4-3/16	5-15/32	3.35

SPECIAL REINFORCED

90° ELBOW

SR Fipt x SR Fipt

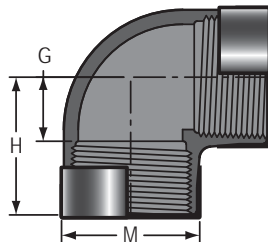

Part Number	Size	G	H	M	Approx. Wt. (Lbs.)
808-003SR	3/8	9/16	1-5/32	15/16	.07
808-005SR	1/2	1/2	1-7/32	1-3/16	.10
808-007SR	3/4	5/8	1-3/8	1-3/8	.13
808-010SR	1	25/32	1-11/16	1-23/32	.23
808-012SR	1-1/4	15/16	1-7/8	2-1/16	.35
808-015SR	1-1/2	1-1/32	2-1/8	2-7/16	.50
808-020SR	2	1-19/32	2-1/2	3	.92



Schedule 80 PVC Technical Information
Schedule 80 Fittings

90° STREET ELBOW

Spigot x Socket

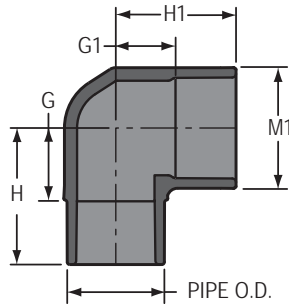

Part Number	Size	G	G1	H	H1	M1	Approx. Wt. (Lbs.)
809-005	1/2	13/16	7/16	1-21/32	1-7/16	1-5/32	.07
809-007	3/4	29/32	11/16	1-27/32	1-11/16	1-3/8	.11
809-010	1	1-1/16	3/4	2-7/32	2	1-23/32	.19
809-012	1-1/4	1-9/32	13/16	2-19/32	2-1/4	2-3/32	.29
809-015	1-1/2	1-7/16	1-3/16	2-13/16	2-9/16	2-3/8	.40
809-020	2	1-3/4	1-7/16	3-1/4	2-31/32	2-7/8	.60
809-025	2-1/2	2-1/2	1-5/8	4-1/2	3-3/8	3-7/16	1.31
809-030	3	2-3/8	1-13/16	4-1/4	3-11/16	4-3/16	1.65
809-040	4	3-1/32	2-1/4	5-9/32	4-17/32	5-1/4	2.82
809-060	6	5-1/4	3-7/8	8-1/2	6-7/8	7-9/16	12.00
809-080	8	7-1/8	4-25/32	11-1/8	8-25/32	9-3/4	17.21
809-100	10	8-5/8	5-13/16	14-5/16	11-3/8	12-1/16	37.73
809-120	12	10-1/8	6-7/8	16-7/8	13-3/8	14-1/8	61.75
809-140	14	11-1/16	7-9/16	18-5/16	14-5/8	15-11/16	73.23
809-140F	14	13-1/2	13-1/2	20-1/2	20-1/2	15-1/2	82.49
809-160F	16	19-9/16	15-9/16	28-9/16	23-9/16	17-11/16	120.78
809-180F	18	22-3/16	17-11/16	32-3/16	26-11/16	19-7/8	140.91
809-200F	20	24-13/16	19-13/16	35-13/16	29-13/16	22-1/16	256.44
809-240F	24	30	24	43	36	26-7/16	395.00

90° STREET ELBOW

Mipt x Fipt

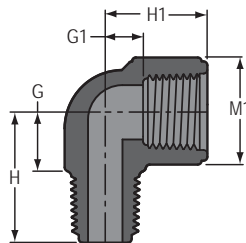

Part Number	Size	G	G1	H	H1	M1	Approx. Wt. (Lbs.)
812-002	1/4	17/32	5/16	1-1/32	29/32	13/16	.02
812-005	1/2	11/16	13/32	1-11/32	1-5/32	1-3/16	.06
812-007	3/4	7/8	17/32	1-1/2	1-9/32	1-7/16	.09
812-010	1	1-1/32	21/32	1-13/16	1-9/16	1-3/4	.15
812-012	1-1/4	2-9/16	1	3-9/32	1-31/32	2-7/32	.49
812-015 ¹	1-1/2	2-11/16	1-1/4	3-7/16	2-1/8	2-13/32	.54

¹ Outlet sized with Female Adapter

Schedule 80 PVC Technical Information
Schedule 80 Fittings



11-1/4° ELBOW

Socket x Socket

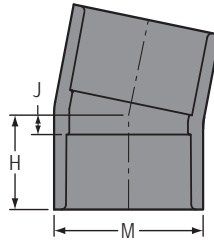

Part Number	Size	H	J	M	Approx. Wt. (Lbs.)
811-015	1-1/2	1-19/32	7/32	2-3/8	.24
811-020	2	1-23/32	7/32	2-27/32	.33
811-025F	2-1/2	2-11/16	11/16	3-7/16	.81
811-030	3	2-3/16	5/16	4-1/8	.88
811-040	4	2-21/32	13/32	5-1/4	1.53
811-045F	4-1/2	3-1/2	1	5-5/8	1.94
811-050F	5	3-13/16	13/16	6-5/16	2.88
811-060F	6	4-1/4	1	7-1/2	4.43
811-080F	8	5-3/8	1-1/8	9-5/8	8.73
811-100F	10	6-11/16	1-7/16	11-15/16	15.93
811-120F	12	7-13/16	1-9/16	14-1/8	24.66
811-140F	14	9	2	15-1/2	33.00
811-160F	16	10-3/8	2-3/8	17-11/16	48.74
811-180F	18	11-3/4	2-3/4	19-7/8	69.12
811-200F	20	13-1/8	3-1/8	22-1/16	96.58
811-240F	24	15-13/16	3-13/16	26-7/16	152.00



30° ELBOW

Socket x Socket

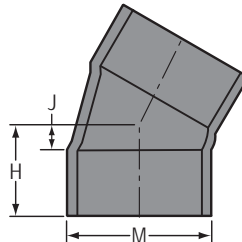

Part Number	Size	H	J	M	Approx. Wt. (Lbs.)
815-005F	1/2	1-7/16	7/16	1-1/8	.07
815-007F	3/4	1-7/16	7/16	1-3/8	.09
815-010F	1	1-3/4	1/2	1-11/16	.14
815-012F	1-1/4	2-3/16	11/16	2-1/16	.22
815-015F	1-1/2	2-3/16	11/16	2-5/16	.30
815-020F	2	2-1/2	3/4	2-13/16	.46
815-025F	2-1/2	2-1/2	3/4	3-7/16	.81
815-030F	3	3-5/16	1-1/16	4-1/8	1.21
815-040F	4	3-7/16	1-3/16	5-3/16	2.14
815-045F	4-1/2	4	1-1/2	5-5/8	2.18
815-050F	5	4-3/8	1-3/8	6-5/16	3.10
815-060	6	4-13/16	1-7/8	7-9/16	5.59



Schedule 80 PVC Technical Information
Schedule 80 Fittings

30° ELBOW (continued)
Socket x Socket

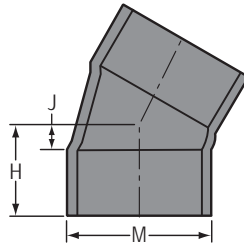

Part Number	Size	H	J	M	Approx. Wt. (Lbs.)
815-080F	8	6-3/16	1-15/16	9-5/8	10.08
815-100F	10	7-3/4	2-1/2	11-15/16	17.92
815-120F	12	9-1/16	2-13/16	14-1/8	27.40
815-140F	14	10-7/16	3-7/16	15-1/2	37.94
815-160F	16	11-15/16	3-15/16	17-11/16	55.09
815-180F	18	13-7/16	4-7/16	19-7/8	77.09
815-200F	20	15	5	22-1/16	119.89
815-240F	24	18-1/8	6-1/8	26-7/16	166.30

22-1/2° ELBOW
Socket x Socket

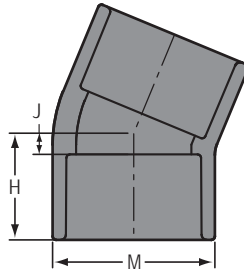

Part Number	Size	H	J	M	Approx. Wt. (Lbs.)
816-005	1/2	1-1/16	3/16	1-5/32	.06
816-007	3/4	1-3/16	3/16	1-7/16	.09
816-010	1	1-3/8	9/32	1-23/32	.13
816-012	1-1/4	1-1/2	5/16	2-3/32	.19
816-015	1-1/2	1-21/32	1/4	2-3/8	.26
816-015F	1-1/2	2-1/8	5/8	2-5/16	.26
816-020	2	1-7/8	7/16	2-7/8	.38
816-025	2-1/2	2-7/32	15/32	3-1/2	.68
816-025F	2-1/2	2-7/8	7/8	3-7/16	.75
816-030	3	2-13/32	9/16	4-5/32	.95
816-040	4	2-7/8	5/8	5-1/4	1.64
816-045F	4-1/2	3-13/16	1-5/16	5-5/8	2.09
816-050F	5	4-1/8	1-1/8	6-5/16	3.15

Schedule 80 PVC Technical Information
Schedule 80 Fittings



22-1/2° ELBOW (continued)

Socket x Socket

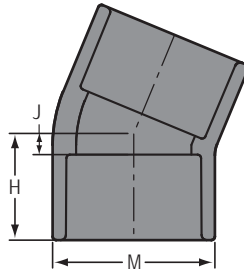

Part Number	Size	H	J	M	Approx. Wt. (Lbs.)
816-060	6	4-9/16	1-3/8	7-7/16	4.33
816-060F	6	4-5/8	1-3/8	7-1/2	5.02
816-080	8	5-1/16	1-1/32	9-3/4	8.19
816-080F	8	5-7/8	1-5/8	9-5/8	9.41
816-100F	10	7-5/16	2-1/16	11-15/16	17.25
816-120F	12	8-9/16	2-5/16	14-1/8	26.03
816-140F	14	9-13/16	2-13/16	15-1/2	34.65
816-160F	16	11-5/16	3-5/16	17-11/16	52.97
816-180F	18	12-3/4	3-3/4	19-7/8	74.44
816-200F	20	14-1/4	4-1/4	22-1/16	119.89
816-240F	24	17-3/16	5-3/16	26-7/16	189.96



22-1/2° STREET ELBOW

Spigot x Socket

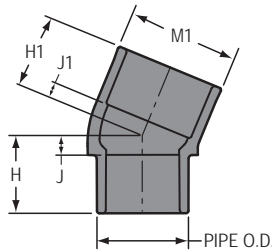

Part Number	Size	H	H1	J	J1	M1	Approx. Wt. (Lbs.)
842-005	1/2	7/8	1	1/8	1/8	1-3/16	.05
842-007	3/4	1-1/4	1-5/32	3/16	3/16	1-3/8	.08
842-010	1	1-7/16	1-11/32	5/16	7/32	1-23/32	.13
842-012	1-1/4	1-9/16	1-9/16	5/16	3/8	2-3/32	.20
842-015	1-1/2	1-21/32	1-7/8	9/32	1/2	2-3/8	.26
842-020	2	2	1-29/32	15/32	13/32	2-7/8	.40
842-025	2-1/2	2-7/32	2-7/32	15/32	15/32	3-1/2	.66
842-030	3	2-1/2	2-5/16	21/32	7/16	4-5/32	1.44
842-040	4	2-27/32	3-1/32	9/16	25/32	5-1/4	1.67
842-060	6	5-11/16	3-15/16	2-3/8	7/8	7-5/8	9.46
842-080	8	7-3/8	5-1/8	3-1/8	1-1/8	9-3/4	5.61



Schedule 80 PVC Technical Information
Schedule 80 Fittings

45° ELBOW

Socket x Socket

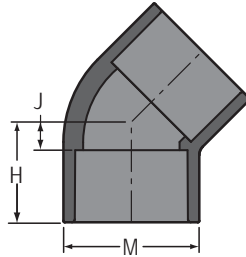

Part Number	Size	H	J	M	Approx. Wt. (Lbs.)
817-002	1/4	13/16	5/32	27/32	.03
817-003	3/8	31/32	7/32	1	.04
817-005	1/2	1-1/8	1/4	1-3/16	.06
817-007	3/4	1-5/16	5/16	1-7/16	.09
817-010	1	1-7/16	5/16	1-23/32	.15
817-012	1-1/4	1-5/8	3/8	2-1/8	.23
817-015	1-1/2	1-13/16	7/16	2-3/8	.30
817-020	2	2-1/8	5/8	2-7/8	.46
817-025	2-1/2	2-13/32	21/32	3-1/2	.77
817-030	3	2-29/32	29/32	4-5/32	1.12
817-040	4	3-5/16	1-1/16	5-1/4	2.00
817-045F	4-1/2	4-1/2	2	5-5/8	2.32
817-050	5	4	1-11/32	6-13/32	3.23
817-050F	5	4-7/8	1-7/8	6-5/16	3.86
817-060	6	4-3/4	1-3/4	7-19/32	5.52
817-080	8	6	2	9-3/4	10.17
817-100	10	8-3/16	2-19/32	12-3/16	20.62
817-100F	10	8-11/16	3-7/16	11-15/16	19.91
817-120	12	9-11/16	3-3/32	14-13/32	34.04
817-120F	12	10-1/8	3-7/8	14-1/8	31.51
817-140	14	10-5/16	3-5/16	15-5/8	40.00
817-140F	14	11-9/16	4-9/16	15-1/2	42.89
817-160F	16	13-5/16	5-5/16	17-11/16	61.45
817-180F	18	15	6	19-7/8	87.73
817-200F	20	16-3/4	6-3/4	22-1/16	107.05
817-240F	24	20-3/16	8-3/16	26-7/16	204.20



Schedule 80 PVC Technical Information
Schedule 80 Fittings



15° ELBOW

Socket x Socket

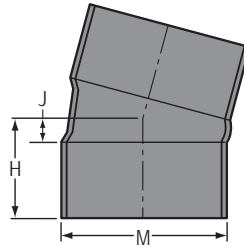

Part Number	Size	H	J	M	Approx. Wt. (Lbs.)
818-020F	2	2-5/16	9/16	2-13/16	.42
818-025F	2-1/2	2-3/4	3/4	3-7/16	.79
818-030F	3	3	3/4	4-1/8	1.10
818-040F	4	3-1/8	7/8	5-3/16	1.90
818-045F	4-1/2	3-5/8	1-1/2	5-5/8	2.00
818-050F	5	3-15/16	15/16	6-5/16	2.98
818-060F	6	4-3/8	1-1/8	7-1/2	4.43
818-080F	8	4-1/2	1-1/4	9-5/8	8.73
818-100F	10	6-15/16	1-11/16	11-15/16	15.93
818-120F	12	8-1/16	1-13/16	14-1/8	24.66
818-140F	14	9-5/16	2-5/16	15-1/2	34.65
818-160F	16	10-11/16	2-11/16	17-11/16	50.85
818-180F	18	12-1/16	3-1/16	19-7/8	71.78
818-200F	20	13-1/2	3-1/2	22-1/16	119.89
818-240F	24	16-1/4	4-1/4	26-7/16	170.96





Schedule 80 PVC Technical Information
Schedule 80 Fittings

45° ELBOW

Fipt x Fipt

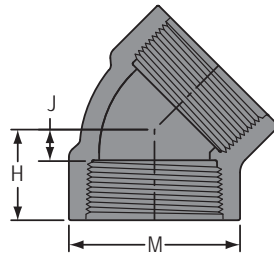

Part Number	Size	H	J	M	Approx. Wt. (Lbs.)
819-002	1/4	25/32	3/16	27/32	.03
819-003	3/8	13/16	3/16	1	.04
819-005	1/2	31/32	5/16	1-3/16	.07
819-007	3/4	1-3/32	13/32	1-3/8	.11
819-010	1	1-7/32	7/32	1-11/16	.14
819-012	1-1/4	1-7/16	7/16	2-3/16	.24
819-015	1-1/2	1-1/2	15/32	2-1/2	.31
819-020	2	1-23/32	21/32	3	.46
819-025	2-1/2	2-17/32	31/32	3-1/2	1.14
819-030	3	2-23/32	1	4-9/32	1.78
819-040	4	3-1/4	1-7/32	5-1/4	2.71

SPECIAL REINFORCED 45° ELBOW

SR Fipt x SR Fipt

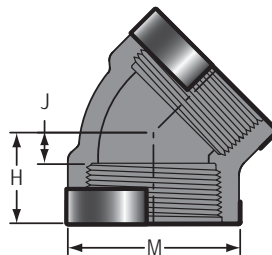

Part Number	Size	H	J	M	Approx. Wt. (Lbs.)
819-005SR	1/2	1	5/16	1-3/16	.09
819-007SR	3/4	1-1/8	13/32	1-3/8	.10
819-010SR	1	1-1/4	13/32	1-23/32	.17

Schedule 80 PVC Technical Information
Schedule 80 Fittings



60° ELBOW
 Socket x Socket

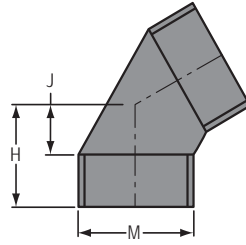

Part Number	Size	H	J	M	Approx. Wt. (Lbs.)
824-005F	1/2	1-5/8	5/8	1-1/8	.13
824-007F	3/4	1-11/16	11/16	1-3/8	.18
824-010F	1	2	3/4	1-11/16	.33
824-012F	1-1/4	2-1/2	1	2-1/16	.68
824-015F	1-1/2	2-5/8	1-1/8	1-3/8	.74
824-020F	2	3	1-1/4	2-13/16	.93
824-025F	2-1/2	3-9/16	1-9/16	3-7/16	.73
824-030F	3	4	1-3/4	4-1/8	2.53
824-040F	4	4-5/16	2-1/16	5-3/16	4.05
824-050F	5	5-3/8	2-3/8	6-5/16	7.08
824-060F	6	6-1/8	2-7/8	7-1/2	9.30
824-080F	8	7-3/4	3-1/2	9-5/8	18.81
824-100F	10	9-11/16	4-7/16	11-15/16	33.04
824-120F	12	11-5/16	5-1/16	14-1/8	31.51
824-140F	14	12-15/16	5-15/16	15-1/2	42.89
824-160F	16	14-13/16	6-13/16	17-11/16	108.07
824-180F	18	16-3/4	7-3/4	19-7/8	95.71
824-200F	20	23-11/16	13-11/16	22-1/16	239.76
824-240F	24	28-11/16	16-11/16	26-7/16	348.00

45° STREET ELBOW
 Spigot x Socket

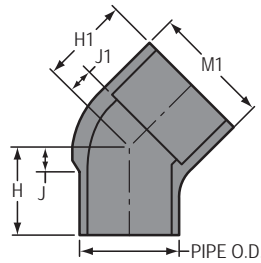

Part Number	Size	H	H1	J	J1	M1	Approx. Wt. (Lbs.)
827-005	1/2	1-9/32	1-5/16	11/32	7/16	1-3/16	.06
827-007	3/4	1-1/2	1-1/2	7/16	1/2	1-13/32	.10
827-010	1	1-25/32	1-1/2	19/32	3/8	1-3/4	.15
827-012	1-1/4	2	1-23/32	5/8	15/32	2-3/32	.22
827-015	1-1/2	2-1/32	2-1/8	19/32	25/32	2-11/32	.30
827-020	2	2-5/16	2-11/32	11/16	3/8	2-27/32	.44
827-025	2-1/2	3-11/16	2-9/16	1-11/16	13/16	3-1/2	1.09
827-030	3	3-1/4	2-13/16	1-3/16	29/32	4-5/32	1.22
827-040	4	3-13/16	3-13/16	1-9/32	1-9/16	5-1/4	2.15
827-060	6	5-3/32	4-25/32	2-1/16	2-1/16	7-19/32	5.70
827-080	8	6-5/8	5-31/32	2-19/32	1-3/4	9-3/4	10.53



Schedule 80 PVC Technical Information
Schedule 80 Fittings

45° STREET ELBOW (continued)

Spigot x Socket

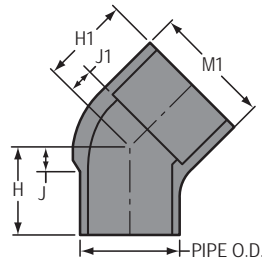

Part Number	Size	H	H1	J	J1	M1	Approx. Wt. (Lbs.)
827-100	10	10-21/32	8-3/16	2-19/32	5-5/16	12-3/16	25.62
827-120	12	13-1/4	9-11/16	6-3/8	3-3/32	14-13/32	45.44
827-140F	14	11-9/16	11-9/16	4-9/16	4-9/16	15-1/2	61.04
827-160F	16	18-5/16	13-5/16	9-5/16	5-5/16	17-11/16	78.40
827-180F	18	20-1/2	15	10-1/2	6	19-7/8	114.32
827-200F	20	22-3/4	16-3/4	11-3/4	6-3/4	22-1/16	156.53
827-240F	24	27-3/16	20-3/16	14-3/16	8-3/16	26-7/16	261.19

CROSS

Socket x Socket x Socket x Socket

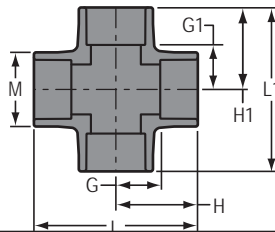

Part Number	Size	G	G1	H	H1	L	L1	M	Approx. Wt. (Lbs.)
820-002	1/4	13/32	13/32	1-1/32	1-1/32	2-1/16	2-1/16	27/32	.05
820-005	1/2	9/16	9/16	1-15/32	1-15/32	2-15/16	2-15/16	1-3/16	.13
820-007	3/4	5/8	5/8	1-5/8	1-5/8	3-9/32	3-9/32	1-13/32	.22
820-010	1	31/32	31/32	2-3/32	2-3/32	4-7/32	4-7/32	1-23/32	.39
820-012	1-1/4	1-3/32	1-3/32	2-3/8	2-3/8	4-3/4	4-3/4	2-1/8	.63
820-015	1-1/2	1-1/4	1-1/4	2-5/8	2-5/8	5-1/4	5-1/4	2-3/8	.80
820-020	2	1-1/2	1-1/2	3	3	6	6	3	1.34
820-025	2-1/2	1-11/16	1-11/16	3-15/32	3-15/32	6-29/32	6-29/32	3-17/32	2.02
820-030	3	2-3/32	2-3/32	3-31/32	3-31/32	7-15/16	7-15/16	4-11/32	3.30
820-040	4	2-5/8	2-5/8	4-7/8	4-7/8	9-3/4	9-3/4	5-11/32	5.31
820-050F	5	5-1/2	5-1/2	8-1/2	8-1/2	17	17	6-5/16	14.69
820-060F	6	6-1/4	6-1/4	9-1/2	9-1/2	19	19	7-1/2	16.19
820-080F	8	7-5/8	7-5/8	11-7/8	11-7/8	23-3/4	23-3/4	9-5/8	28.22
820-100F	10	9	9	14-1/4	14-1/4	28-1/2	28-1/2	11-15/16	49.78
820-120F	12	11-1/4	11-1/4	17-1/2	17-1/2	35	35	14-1/8	80.83
820-140F	14	12-1/4	12-1/4	19-1/4	19-1/4	38-1/2	38-1/2	15-1/2	108.89
820-160F	16	13	13	21	21	42	42	17-11/16	156.80
820-180F	18	13-3/4	13-3/4	22-3/4	22-3/4	45-1/2	45-1/2	19-7/8	215.35
820-200F	20	16-3/8	16-3/8	26-3/8	26-3/8	52-3/4	52-3/4	22-1/16	300.00
820-240F	24	20-1/4	20-1/4	32-1/4	32-1/4	64-1/2	64-1/2	26-7/16	527.13

Schedule 80 PVC Technical Information
Schedule 80 Fittings



REDUCING CROSS

Socket x Socket x Socket x Socket

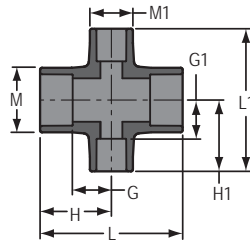

Part Number	Size	G	G1	H	H1	L	L1	M	M1	Approx. Wt. (Lbs.)
820-130 ¹	1x1x1/2x1/2	1	1-7/16	2-1/8	2-3/8	4-7/32	4-3/4	1-23/32	1-23/32	.56
820-131	1x1x1/2x3/4	23/32	5/8	1-5/8	1-5/8	3-1/4	3-1/4	1-7/8	1-1/2	.30
820-166 ¹	1-1/4x1-1/4x1/2x1/2	1-3/32	1-3/32	2-3/8	2-11/16	4-3/4	5-3/16	3-3/32	3-3/32	.82
820-167	1-1/4x1-1/4x3/4x3/4	1-1/16	23/32	2-1/16	1-31/32	4-3/32	3-31/32	2-1/16	1-13/32	.33
820-209 ¹	1-1/2x1-1/2x1/2x1/2	1-7/32	1-7/32	2-21/32	2-31/32	5-1/4	5-15/16	2-3/8	2-3/8	1.18
820-210	1-1/2x1-1/2x3/4x3/4	11/16	1-5/32	2-3/32	2-3/16	4-3/16	4-11/32	2-3/8	1-13/32	.40
820-211 ¹	1-1/2x1-1/2x1x1	1-3/4	1-3/4	2-5/8	3	5-5/16	5-7/8	1-3/8	1-3/8	1.12
820-248	2x2x3/4x3/4	11/16	1-7/16	2-7/32	2-7/16	4-13/32	4-7/8	2-29/32	1-13/32	.55
820-249 ¹	2x2x1x1	1-1/2	2-9/32	3	3-7/16	6	6-27/32	3	3	1.81
820-251	2x2x1-1/2x1-1/2	1-1/2	2	3	3-3/8	6	6-3/4	2-7/8	2-7/8	1.72
820-289	2-1/2x2-1/2x1x1	7/8	1-23/32	2-11/16	2-7/8	5-11/32	5-3/4	3-1/2	1-3/4	.97
820-291 ¹	2-1/2x2-1/2x1-1/2x1-1/2	1-11/16	2-15/32	3-7/16	3-27/32	6-7/8	7-23/32	3-9/16	3-9/16	2.83
820-336 ¹	3x3x1-1/4x1-1/4	2-3/32	3-1/8	3-31/32	4-3/8	7-29/32	8-3/4	4-3/16	4-3/16	4.23
820-338 ¹	3x3x2x2	2-3/32	2-27/32	3-31/32	4-5/16	7-29/32	8-5/8	4-13/32	4-5/16	4.23
820-420 ¹	4x4x2x2	2-5/8	3-13/16	4-7/8	5-11/32	9-3/4	10-21/32	5-11/32	5-7/32	7.33
820-420F	4x4x2x2	3-7/8	4-1/4	6-1/8	6	12-1/4	12	5-3/16	2-13/16	5.26
820-422 ¹	4x4x3x3	2-5/8	3-7/16	4-7/8	5-5/16	9-3/4	10-5/8	5-1/4	5-1/4	6.94
820-528F	6x6x2x2	4-5/8	5-3/16	7-7/8	6-15/16	15-3/4	13-7/8	7-1/2	2-13/16	7.19
820-530F	6x6x3x3	4-3/4	5-3/4	8	8	16	16	7-1/2	4-1/8	12.60
820-532F	6x6x4x4	5-1/4	6-3/4	8-1/2	9	17	18	7-1/2	5-3/16	14.54
820-533F	6x6x5x5	5-3/4	6-1/2	9	9-1/2	18	19	7-1/2	6-5/16	14.00
820-578F	8x8x2x2	4-11/16	6-1/8	8-15/16	7-7/8	17-7/8	15-3/4	9-5/8	2-13/16	11.30
820-580F	8x8x3x3	5-3/16	6-11/16	9-7/16	8-15/16	18-7/8	17-7/8	9-5/8	4-1/8	12.93
820-582F	8x8x4x4	5-3/4	7-11/16	10	9-15/16	20	19-7/8	9-5/8	5-3/16	21.87
820-585F	8x8x6x6	6-3/4	8-1/16	11	11-5/16	22	22-5/8	9-5/8	7-1/2	30.04
820-621F	10x10x2x2	4-3/8	7-1/8	9-5/8	8-7/8	19-1/4	17-11/16	11-15/16	2-13/16	19.45
820-622F	10x10x2-1/2x2-1/2	5-1/4	7-5/16	10-1/2	9-5/16	21	18-5/8	11-15/16	3-7/16	20.00
820-623F	10x10x3x3	4-7/8	7-11/16	10-1/8	9-15/16	20-1/4	19-13/16	11-15/16	4-1/8	21.42
820-624F	10x10x4x4	5-3/8	8-11/16	10-5/8	10-15/16	21-1/4	21-13/16	11-15/16	5-3/16	24.17
820-626F	10x10x6x6	5-7/8	9-1/16	11-1/8	12-5/16	22-1/4	24-5/8	11-15/16	7-1/2	40.79
820-628F	10x10x8x8	8-1/4	9-15/16	13-1/2	14-3/16	27	28-3/8	11-15/16	9-5/8	65.94
820-661F	12x12x2x2	4-3/4	8	11	9-3/4	22	19-1/2	14-1/8	2-13/16	29.32
820-663F	12x12x3x3	5-1/4	8-9/16	11-1/2	10-13/16	23	21-5/8	14-1/8	4-1/8	33.02
820-664F	12x12x4x4	5-3/4	9-9/16	12	11-13/16	24	23-5/8	14-1/8	5-3/16	33.78
820-666F	12x12x6x6	7-1/4	9-15/16	13-1/4	13-3/16	26-1/2	26-3/8	14-1/8	7-1/2	57.20
820-668F	12x12x8x8	8	10-13/16	14-1/4	15-1/16	28-1/2	30-1/8	14-1/8	9-5/8	66.12
820-670F	12x12x10x10	10-1/4	10-13/16	16-1/2	16-1/16	33	32-1/8	14-1/8	11-15/16	105.91
820-691F	14x14x2x2	5-3/16	8-9/16	12-3/16	10-5/16	24-3/8	20-5/8	15-1/2	2-13/16	38.49
820-693F	14x14x3x3	5-3/4	9-1/8	12-3/4	11-3/8	25-1/2	22-3/4	15-1/2	4-1/8	49.59

¹ Outlet sized with bushing





Schedule 80 PVC Technical Information
Schedule 80 Fittings

REDUCING CROSS (continued)

Socket x Socket x Socket x Socket

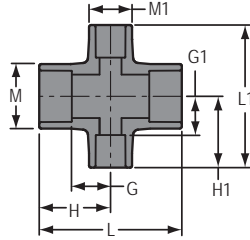

Part Number PVC	Size	G	G1	H	H1	L	L1	M	M1	Approx. Wt. (Lbs.)
										PVC
820-694F	14x14x4x4	6-1/2	10-1/8	13-1/2	12-3/8	27	24-3/4	15-1/2	5-3/16	43.51
820-696F	14x14x6x6	8-1/4	10-1/2	15-1/4	13-3/4	30-1/2	27-1/2	15-1/2	7-1/2	78.72
820-698F	14x14x8x8	9-1/4	11-3/8	16-1/4	15-5/8	32-1/2	31-1/4	15-1/2	9-5/8	75.53
820-700F	14x14x10x10	10-1/8	11-3/8	17-1/8	16-5/8	34-1/4	33-1/4	15-1/2	11-15/16	95.66
820-702F	14x14x12x12	11	11-3/8	18	17-5/8	36	35-1/4	15-1/2	14-1/8	98.88
820-751F	16x16x2x2	5-7/8	9-1/2	13-7/8	11-1/4	27-3/4	22-1/2	17-11/16	2-13/16	55.64
820-752F	16x16x2-1/2x2-1/2	6	9-11/16	14	11-11/16	28	23-3/8	17-11/16	3-7/16	56.18
820-753F	16x16x3x3	6-5/16	10-1/16	14-5/16	12-5/16	28-5/8	24-5/8	17-11/16	4-1/8	58.72
820-754F	16x16x4x4	6-1/8	11-1/16	14-1/8	13-5/16	28-1/4	26-5/8	17-11/16	5-3/16	61.59
820-756F	16x16x6x6	8-5/8	11-7/16	16-5/8	14-11/16	33-1/4	29-3/8	17-11/16	7-1/2	93.13
820-758F	16x16x8x8	9-5/8	12-5/16	17-5/8	16-9/16	35-1/4	33-1/8	17-11/16	9-5/8	91.88
820-760F	16x16x10x10	10-5/8	12-5/16	18-5/8	17-9/16	37-1/4	35-1/8	17-11/16	11-15/16	104.59
820-762F	16x16x12x12	11-5/8	12-5/16	19-5/8	18-9/16	39-1/4	37-1/8	17-11/16	14-1/8	141.98
820-764F	16x16x14x14	12-3/4	12-11/16	20-3/4	19-11/16	41-1/2	39-3/8	17-11/16	15-1/2	129.00
820-784F	18x18x4x4	6-7/8	11-15/16	15-7/8	14-3/16	31-3/4	28-3/8	19-7/8	5-3/16	92.66
820-786F	18x18x6x6	8-1/2	12-5/16	17-1/2	15-9/16	35	31-1/8	19-7/8	7-1/2	118.63
820-788F	18x18x8x8	9-1/2	13-3/16	18-1/2	17-7/16	37	34-7/8	19-7/8	9-5/8	128.81
820-790F	18x18x10x10	10-1/2	13-3/16	19-1/2	18-7/16	39	36-7/8	19-7/8	11-15/16	130.87
820-792F	18x18x12x12	11-1/2	13-3/16	20-1/2	19-7/16	41	38-7/8	19-7/8	14-1/8	147.26
820-794F	18x18x14x14	12-3/4	13-9/16	21-3/4	20-9/16	43-1/2	41-1/8	19-11/16	15-1/2	164.25
820-796F	18x18x16x16	13-1/2	14-3/16	22-1/2	22-3/16	45	44-3/8	19-11/16	17-11/16	189.00
820-814F	20x20x4x4	7-11/16	12-7/8	17-11/16	15-1/8	35-3/8	30-1/4	22-1/16	5-3/16	115.50
820-816F	20x20x6x6	8-7/8	13-1/4	18-7/8	16-1/2	37-3/4	33	22-1/16	7-1/2	133.63
820-818F	20x20x8x8	9-7/8	14-1/8	19-7/8	18-3/8	39-3/4	36-3/4	22-1/16	9-5/8	153.30
820-820F	20x20x10x10	10-7/8	14-1/8	20-7/8	19-3/8	41-3/4	38-3/4	22-1/16	11-15/16	168.43
820-822F	20x20x12x12	11-7/8	14-1/8	21-7/8	20-3/8	43-3/4	40-3/4	22-1/16	14-1/8	186.06
820-824F	20x20x14x14	12-7/8	14-1/2	22-7/8	21-1/2	45-3/4	43	22-1/16	15-1/2	204.39
820-826F	20x20x16x16	14	15-1/8	24	23-1/8	48	46-1/4	22-1/16	17-11/16	230.10
820-828F	20x20x18x18	15	15	25	24	50	48	22-1/16	19-7/8	258.28
820-904F	24x24x4x4	9	14-11/16	21	16-15/16	42	33-7/8	26-7/16	5-3/16	192.22
820-906F	24x24x6x6	9-1/4	15-1/16	21-1/4	18-5/16	42-1/2	36-5/8	26-7/16	7-1/2	211.33
820-908F	24x24x8x8	10-1/4	15-15/16	22-1/4	20-3/16	44-1/2	40-3/8	26-7/16	9-5/8	221.76
820-910F	24x24x10x10	11-1/4	15-15/16	23-1/4	21-3/16	46-1/2	42-3/8	26-7/16	11-15/16	249.91
820-912F	24x24x12x12	12-1/4	15-15/16	24-1/4	22-3/16	48-1/2	44-3/8	26-7/16	14-1/8	279.88

Schedule 80 PVC Technical Information
Schedule 80 Fittings



REDUCING CROSS (continued)

Socket x Socket x Socket x Socket

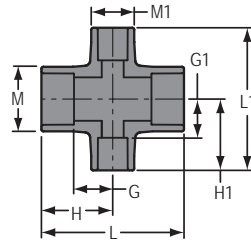

Part Number PVC	Size	G	G1	H	H1	L	L1	M	M1	Approx. Wt. (Lbs.)
										PVC
820-914F	24x24x14x14	13-1/4	16-5/16	25-1/4	23-5/16	50-1/2	46-5/8	26-1/16	15-1/2	301.05
820-916F	24x24x16x16	14-3/4	16-15/16	26-3/4	24-15/16	53-1/2	49-7/8	26-7/16	17-11/16	329.60
820-918F	24x24x18x18	15-3/4	16-13/16	27-3/4	25-13/16	55-1/2	51-5/8	26-7/16	19-7/8	360.62
820-920F	24x24x20x20	16-3/4	18-3/16	28-3/4	28-3/16	57-1/2	56-3/8	26-7/16	22-1/16	398.22



COUPLING

Socket x Socket

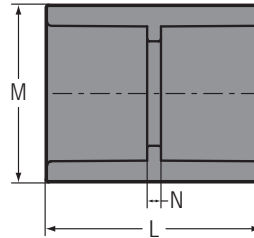

Part Number	Size	L	M	N	Approx. Wt. (Lbs.)
829-002	1/4	1-3/8	27/32	1/16	.02
829-003	3/8	1-5/8	1	3/32	.03
829-005	1/2	1-7/8	1-3/16	1/8	.05
829-007	3/4	2-1/8	1-13/32	1/8	.07
829-010	1	2-15/32	1-23/32	3/16	.13
829-012	1-1/4	2-23/32	2-7/32	7/32	.22
829-015	1-1/2	2-7/8	2-11/32	3/32	.21
829-020	2	3-1/8	2-27/32	3/32	.31
829-025	2-1/2	3-11/16	3-15/32	1/4	.55
829-030	3	3-31/32	4-5/32	3/16	.79
829-040	4	4-3/4	5-5/16	1/4	1.34
829-050	5	5-21/32	6-3/8	3/16	2.06
829-050F	5	7-3/8	6-5/16	1-3/8	2.60
829-060	6	6-3/8	7-9/16	1/4	3.39
829-080	8	8-1/4	9-23/32	9/32	6.55
829-100	10	10-9/32	12-1/16	1/4	11.76
829-100F	10	12-1/2	11-15/16	2	13.94
829-120	12	12-3/8	14-7/32	3/8	19.39
829-120F	12	14-1/4	14-1/8	1-3/4	21.92



Schedule 80 PVC Technical Information
Schedule 80 Fittings

COUPLING (continued)
 Socket x Socket

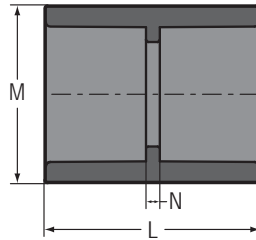

Part Number	Size	L	M	N	Approx. Wt. (Lbs.)
829-140	14	14-7/16	15-5/8	3/8	29.70
829-140F	14	16-1/4	15-1/2	2-1/4	29.70
829-160F	16	18-5/8	17-11/16	2-5/8	42.38
829-180F	18	22	19-7/8	4	63.81
829-200F	20	23-3/4	22-1/16	3-3/4	86.58
829-240F	24	29-1/4	26-7/16	5-1/4	147.22

REDUCER COUPLING
 Socket x Socket

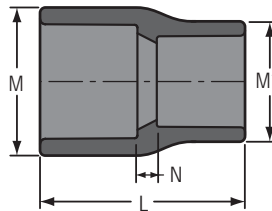

Part Number	Size	L	M	M1	N	Approx. Wt. (Lbs.)
829-101	3/4x1/2	2-3/32	1-13/32	1-5/32	7/32	.07
829-130	1x1/2	2-3/16	1-23/32	1-13/32	7/32	.11
829-131	1x3/4	2-13/32	1-23/32	1-13/32	1/4	.10
829-166	1-1/4x1/2	2-9/16	2-3/32	1-5/32	7/16	.13
829-167	1-1/4x3/4	2-19/32	2-3/32	1-5/8	11/32	.17
829-168	1-1/4x1	2-11/16	2-1/8	1-3/4	5/16	.17
829-209	1-1/2x1/2	2-27/32	2-11/32	1-3/16	19/32	.19
829-210	1-1/2x3/4	2-7/8	2-3/8	1-13/32	17/32	.21
829-211	1-1/2x1	2-7/8	2-11/32	1-15/16	3/8	.26
829-212	1-1/2x1-1/4	2-13/16	2-13/32	2-1/8	5/32	.22
829-247	2x1/2	3-3/32	2-7/8	1-5/32	11/16	.30
829-248	2x3/4	3-7/32	2-7/8	1-13/32	23/32	.30
829-249	2x1	3-1/8	2-7/8	1-23/32	17/32	.33
829-250	2x1-1/4	3-11/32	2-7/8	2-3/32	19/32	.31
829-251	2x1-1/2	3-7/32	2-27/32	2-11/32	1/4	.30
829-290 ¹	2-1/2x1-1/4	3-29/32	3-1/2	2-3/8	15/16	.57
829-291	2-1/2x1-1/2	3-3/4	3-1/2	2-3/8	19/32	.51
829-292	2-1/2x2	3-21/32	3-15/32	2-27/32	13/32	.48
829-335	3x1	4-7/16	4-1/8	2-7/8	1-7/16	1.00
829-336 ¹	3x1-1/4	4-7/32	4-5/32	2-29/32	1-1/16	.94
829-337	3x1-1/2	3-1/2	4-3/16	2-3/8	7/32	.71

¹ Outlet sized with bushing

Schedule 80 PVC Technical Information
Schedule 80 Fittings



REDUCER COUPLING

(continued)

Socket x Socket

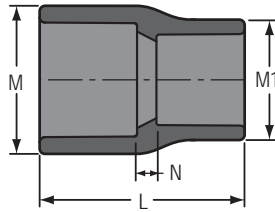

Part Number	Size	L	M	M1	N	Approx. Wt. (Lbs.)
829-338	3x2	4	4-5/32	2-7/8	5/8	.74
829-339	3x2-1/2	4-1/8	4-5/32	3-15/32	1/2	.77
829-339F	3x2-1/2	6	4-1/16	3-7/16	1-3/4	.90
829-416 ¹	4x3/4	5-23/32	5-9/32	2-29/32	2-13/32	1.67
829-417 ¹	4x1	5-15/16	5-9/32	2-29/32	2-17/32	1.71
829-419 ¹	4x1-1/2	5-23/32	5-9/32	2-29/32	2-1/16	1.59
829-420	4x2	5-1/2	5-9/32	2-7/8	1-25/32	1.45
829-421	4x2-1/2	4-9/16	5-3/16	3-1/2	17/32	1.25
829-422	4x3	4-19/32	5-1/4	4-3/16	15/32	1.25
829-460F	4-1/2x4	6-15/16	5-5/8	5-3/16	2-3/16	1.97
829-487F	5x2-1/2	8-1/8	6-1/4	5-3/16	3-5/8	2.64
829-488F	5x3	7-15/16	6-1/4	5-3/16	2-15/16	3.08
829-490F	5x4	7-3/4	6-1/4	5-3/16	2-1/2	2.09
829-491F	5x4-1/2	8-3/16	6-1/4	5-5/8	2-15/16	3.22
829-528 ¹	6x2	7-1/16	7-1/2	5	2-9/16	4.37
829-529 ¹	6x2-1/2	6-31/32	7-19/32	5-9/32	2-3/16	4.30
829-530 ¹	6x3	7-1/8	7-9/16	5-9/32	2-1/4	4.07
829-530F	6x3	9-3/16	7-5/16	5-3/16	3-15/16	3.85
829-532	6x4	6-5/8	7-5/8	5-5/16	1-7/16	3.28
829-533F	6x5	8-15/16	7-3/8	6-5/16	2-11/16	3.57
829-534F	6x4-1/2	9-5/16	7-5/16	5-5/8	3-9/16	3.22
829-579F	8x2-1/2	15	9-1/2	5-3/16	8-3/4	8.33
829-580F	8x3	14-15/16	9-1/2	5-3/16	8-11/16	7.95
829-582	8x4	8-29/32	9-23/32	5-1/4	2-15/32	6.31
829-582F	8x4	14-5/8	9-1/2	5-3/16	8-1/8	8.17
829-583F	8x5	14-11/16	9-1/2	6-5/16	7-7/16	7.78
829-585	8x6	8	9-3/4	7-1/2	1	6.16
829-621F	10x2	21-1/2	11-3/4	5-3/16	14-3/4	16.16
829-623F	10x3	21-7/16	11-3/4	5-3/16	14-3/16	15.77
829-624F	10x4	21-1/8	11-3/4	5-3/16	13-5/8	17.13
829-625F	10x5	21-3/16	11-3/4	6-5/16	12-15/16	16.38
829-626	10x6	10-19/32	12-1/32	7-19/32	2-17/32	11.08
829-626F	10x6	17-1/2	11-3/4	7-1/2	9	14.72
829-628	10x8	10-5/8	12	9-3/4	1-17/32	11.26
829-628F	10x8	13-1/4	11-3/4	9-5/8	3-3/4	11.42
829-664F	12x4	28-3/8	13-15/16	5-3/16	19-7/8	31.70
829-665F	12x5	28-7/16	13-15/16	6-5/16	19-3/16	27.25
829-666F	12x6	24-3/4	13-15/16	7-1/2	15-1/4	26.96
829-668	12x8	12-5/8	14-7/32	9-3/4	2-7/16	17.92
829-668F	12x8	20-1/2	13-15/16	9-5/8	10	24.34

¹ Outlet sized with bushing





Schedule 80 PVC Technical Information
Schedule 80 Fittings

REDUCER COUPLING (continued)

Socket x Socket

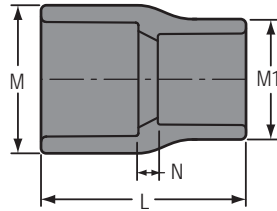

Part Number	Size	L	M	M1	N	Approx. Wt. (Lbs.)
829-670F	12x10	16-3/8	13-15/16	11-15/16	4-7/8	18.92
829-694F	14x4	30-1/8	15-3/16	5-3/16	20-7/8	31.56
829-696F	14x6	26-1/2	15-3/16	7-1/2	16-1/4	29.65
829-698F	14x8	22-1/4	15-3/16	9-5/8	11	29.32
829-700F	14x10	18-1/8	15-3/16	11-15/16	5-7/8	22.90
829-702F	14x12	17-3/4	15-3/8	14-1/8	4-1/2	27.40
829-754F	16x4	38	17-3/8	5-3/16	27-3/4	50.97
829-756F	16x6	34-3/8	17-3/8	7-1/2	23-1/8	61.19
829-758F	16x8	30-1/8	17-3/8	9-5/8	17-7/8	52.73
829-760F	16x10	26	17-3/8	11-15/16	12-3/4	43.70
829-762F	16x12	20-1/4	17-3/8	14-1/8	6	34.25
829-764F	16x14	21-1/4	17-1/2	15-1/2	5-1/4	42.89
829-784F	18x4	47-3/8	19-11/16	5-3/16	36-1/8	104.77
829-786F	18x6	43-3/4	19-11/16	7-1/2	31-1/2	91.02
829-788F	18x8	39-1/2	19-11/16	9-5/8	26-1/4	86.65
829-790F	18x10	35-3/8	19-11/16	11-15/16	21-1/8	91.28
829-792F	18x12	29-5/8	19-11/16	14-1/8	14-3/8	73.27
829-794F	18x14	29-5/8	19-11/16	15-1/2	13-5/8	73.72
829-796F	18x16	23	19-11/16	17-11/16	6	55.09
829-814F	20x4	58	21-7/8	5-3/16	45-3/4	152.76
829-816F	20x6	54-1/2	21-7/8	7-1/2	41-1/8	136.93
829-818F	20x8	50-1/8	21-7/8	9-5/8	35-7/8	144.26
829-820F	20x10	46	21-7/8	11-15/16	30-3/4	139.44
829-822F	20x12	40-1/4	21-7/8	14-1/8	24	119.04
829-824F	20x14	40-1/4	21-7/8	15-1/2	23-1/4	118.17
829-826F	20x16	33-5/8	21-7/8	17-11/16	15-5/8	100.87
829-828F	20x18	25-1/2	21-7/8	19-7/8	6-1/2	79.76
829-904F	24x4	71-1/2	26-1/16	5-3/16	57-1/4	231.96
829-906F	24x6	67-7/8	26-1/16	7-1/2	52-5/8	229.16
829-908F	24x8	63-5/8	26-1/16	9-5/8	47-3/8	223.42
829-910F	24x10	59-1/2	26-1/16	11-15/16	42-1/4	218.80
829-912F	24x12	53-3/4	26-1/16	14-1/8	35-1/2	192.82
829-914F	24x14	53-3/4	26-1/16	15-1/2	34-3/4	225.10
829-916F	24x16	47-1/8	26-1/16	17-11/16	27-1/8	171.54
829-918F	24x18	39	26-1/16	19-7/8	18	147.20
829-920F	24x20	30-5/8	26-1/16	22-1/16	8-5/8	116.56

Schedule 80 PVC Technical Information
Schedule 80 Fittings



ECCENTRIC REDUCER COUPLING

Socket x Socket

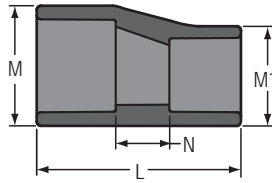

Part Number	Size	L	M	M1	N	Approx. Wt. (Lbs.)
829-101FE	3/4x1/2	3-3/8	1-3/8	1-1/8	1-5/8	.09
829-130FE	1x1/2	3-1/2	1-5/8	1-1/8	1-1/2	.12
829-131FE	1x3/4	4	1-5/8	1-3/8	1-3/4	.13
829-168FE	1-1/4x1	5-1/8	2	1-11/16	2-3/8	.24
829-209FE	1-1/2x1/2	7-1/8	2-1/4	1-1/8	4-7/8	.30
829-210FE	1-1/2x3/4	7-5/8	2-1/4	1-3/8	5-1/8	.33
829-211FE	1-1/2x1	5-3/8	2-1/4	1-11/16	2-5/8	.33
829-212FE	1-1/2x1-1/4	4-9/16	2-5/16	2-1/16	1-9/16	.37
829-249FE	2x1	6-1/8	2-3/4	1-11/16	3-1/8	.39
829-250FE	2x1-1/4	6-1/8	2-3/4	2-1/16	2-7/8	.37
829-251FE	2x1-1/2	6	2-3/4	2-5/16	2-3/4	.46
829-289FE	2-1/2x1	10-5/8	3-5/16	1-11/16	7-3/8	.88
829-290FE	2-1/2x1-1/4	10-5/8	3-5/16	2-1/16	7-1/8	.91
829-291FE	2-1/2x1-1/2	10-1/2	3-5/16	2-5/16	7	.91
829-292FE	2-1/2x2	6-7/8	3-5/16	2-13/16	3-1/8	.68
829-335FE	3x1	11-7/8	3-15/16	1-11/16	8-3/8	1.17
829-336FE	3x1-1/4	11-7/8	3-15/16	2-1/16	8-1/8	1.10
829-337FE	3x1-1/2	11-3/4	3-15/16	2-5/16	8	1.28
829-338FE	3x2	5-7/8	4-5/32	2-7/8	2-15/32	1.01
829-339FE	3x2-1/2	7-1/4	4-1/16	3-7/16	3	1.12
829-417FE	4x1	17	5-1/8	1-11/16	13-1/2	2.75
829-418FE	4x1-1/4	17	5-1/8	2-1/16	13-1/4	2.65
829-419FE	4x1-1/2	16-7/8	5-1/8	2-5/16	13-1/8	3.10
829-420FE	4x2	13-1/4	5-1/8	2-13/16	9-1/4	2.83
829-421FE	4x2-1/2	12-3/8	5-1/8	3-7/16	8-1/8	2.42
829-422FE	4x3	8-3/4	5-1/8	4-1/8	4-1/4	1.70
829-528FE	6x2	20-7/8	7-5/16	2-13/16	15-7/8	5.86
829-529FE	6x2-1/2	20	7-5/16	3-7/16	14-3/4	5.77
829-530FE	6x3	16-3/8	7-5/16	4-1/8	10-7/8	6.24
829-532FE	6x4	11-1/8	7-5/16	5-3/16	5-5/8	3.39
829-533FE	6x5	11-1/4	7-3/8	6-5/16	5	4.32
829-578FE	8x2	30-5/8	9-1/2	2-13/16	24-5/8	11.96
829-580FE	8x3	26-1/8	9-1/2	4-1/8	19-5/8	11.13
829-582FE	8x4	20-7/8	9-1/2	5-3/16	14-3/8	11.54
829-583FE	8x5	21	9-1/2	6-5/16	13-3/4	10.77
829-585FE	8x6	15-1/4	9-1/2	7-1/2	7-3/4	8.41
829-624FE	10x4	32	11-3/4	5-3/16	24-1/2	25.43
829-625FE	10x5	32-1/8	11-3/4	6-5/16	23-7/8	22.82
829-626FE	10x6	26-3/8	11-3/4	7-1/2	17-7/8	22.31
829-628FE	10x8	18-1/16	11-3/4	9-5/8	8-9/16	14.78
829-664FE	12x4	43-1/2	13-15/16	5-3/16	35	42.54





Schedule 80 PVC Technical Information
Schedule 80 Fittings

ECENTRIC REDUCER COUPLING

(continued)

Socket x Socket

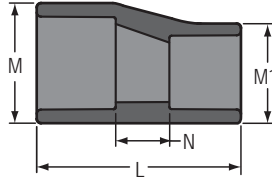

Part Number	Size	L	M	M1	N	Approx. Wt. (Lbs.)
829-665FE	12x5	43-5/8	13-15/16	6-5/16	34-3/8	41.73
829-666FE	12x6	37-7/8	13-15/16	7-1/2	28-3/8	35.33
829-668FE	12x8	29-9/16	13-15/16	9-5/8	19-1/16	32.68
829-670FE	12x10	20-5/8	13-15/16	11-15/16	9-1/8	24.89
829-696FE	14x6	41-3/8	15-3/16	7-1/2	31-1/8	56.76
829-698FE	14x8	33-1/16	15-3/16	9-5/8	21-13/16	53.73
829-700FE	14x10	24-1/8	15-3/16	11-15/16	11-7/8	51.42
829-702FE	14x12	20-1/8	15-3/8	14-1/8	6-7/8	30.11
829-756FE	16x6	54-1/4	17-1/2	7-1/2	43	113.09
829-758FE	16x8	45-15/16	17-1/2	9-5/8	33-11/16	69.73
829-760FE	16x10	37	17-1/2	11-15/16	23-3/4	59.25
829-762FE	16x12	33	17-1/2	14-1/8	18-3/4	63.26
829-764FE	16x14	24-5/8	17-1/2	15-1/2	9-5/8	45.99
829-786FE	18x6	69-1/4	19-11/16	7-1/2	57	145.31
829-788FE	18x8	60-15/16	19-11/16	9-5/8	47-11/16	140.24
829-790FE	18x10	52	19-11/16	11-15/16	37-3/4	109.43
829-792FE	18x12	48	19-11/16	14-1/8	32-3/4	118.07
829-794FE	18x14	39-5/8	19-11/16	15-1/2	23-5/8	97.05
829-796FE	18x16	28-5/8	19-11/16	17-11/16	11-5/8	66.94

FABRICATED REPAIR COUPLING

Gasket x Gasket

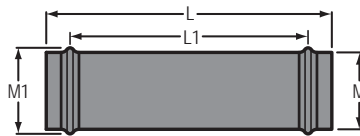

Part Number	Size	L	L1	M	M1	Approx. Wt. (Lbs.)
828-020F	2	9-1/8	11-3/4	4-1/8	4-5/8	.79
828-030F	3	15-1/2	11-3/4	4-1/8	4-5/8	3.26
828-040F	4	19-1/2	15	5-3/16	5-3/4	5.82
828-060F	6	23	16	7-1/2	8-1/8	12.61
828-080F	8	26-5/8	19-11/16	9-5/8	10-3/8	21.39
828-100F	10	28	21-1/4	10-3/4	12-1/4	32.98
828-120F	12	30	22-1/2	14-1/8	16-1/8	46.66
828-140F	14	19	11-1/2	15-1/2	16-3/8	39.40
828-160F	16	21-5/8	12-3/8	17-11/16	18-3/4	57.20

Schedule 80 PVC Technical Information
Schedule 80 Fittings



COUPLING

Fipt x Fipt

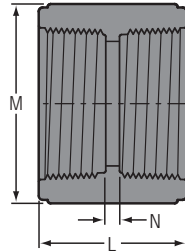

Part Number	Size	L	M	N	Approx. Wt. (Lbs.)
830-002	1/4	1-11/32	13/16	5/32	.03
830-003	3/8	1-15/32	1	9/32	.04
830-005	1/2	1-5/8	1-9/32	1/4	.07
830-007	3/4	1-11/16	1-5/8	3/32	.09
830-010	1	2-3/32	1-15/16	1/8	.15
830-012	1-1/4	2-3/16	2-9/32	3/16	.21
830-015	1-1/2	2-7/32	2-5/8	3/16	.28
830-020	2	2-7/32	3	7/32	.33
830-025	2-1/2	3-5/16	3-9/16	1/8	.68
830-030	3	3-15/32	4-3/8	21/32	1.12
830-040	4	3-21/32	5-9/16	3/16	1.52
830-060F	6	3-3/4	7-3/16	3/4	1.65
830-080F	8	4-1/2	9-3/8	1-1/16	2.84



SPECIAL REINFORCED COUPLING

SR Fipt x SR Fipt

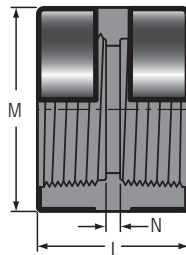

Part Number	Size	L	M	N	Approx. Wt. (Lbs.)
830-005SR	1/2	1-19/32	1-7/32	9/32	.06
830-007SR	3/4	1-5/8	1-3/8	1/8	.07
830-010SR	1	1-15/16	1-23/32	1/16	.13
830-012SR	1-1/4	2-1/16	2-1/16	5/16	.17
830-015SR	1-1/2	2-5/32	2-7/16	11/32	.27
830-020SR	2	2-1/4	3-1/32	1/4	.37



Schedule 80 PVC Technical Information
Schedule 80 Fittings

REDUCER COUPLING

Fipt x Fipt

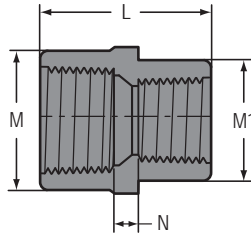

Part Number	Size	L	M	M1	N	Approx. Wt. (Lbs.)
830-072 ¹	1/2x1/4	1-31/32	1-5/16	1-5/32	5/8	.07
830-073 ¹	1/2x3/8	1-29/32	1-7/32	1-7/32	19/32	.06
830-101	3/4x1/2	1-23/32	1-3/8	1-7/32	7/32	.07
830-211 ¹	1-1/2x1	2-7/8	2-11/32	2-11/32	1-1/32	.27

¹ Outlet sized with bushing

SPECIAL REINFORCED REDUCER COUPLING

SR Fipt x SR Fipt

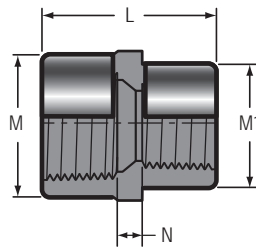

Part Number	Size	L	M	M1	N	Approx. Wt. (Lbs.)
830-101SR	3/4x1/2	1-23/32	1-3/8	1-7/32	7/32	.08
830-130SR	1x1/2	2-1/4	1-23/32	1-7/32	21/32	.16
830-131SR	1x3/4	2-13/32	1-23/32	1-3/8	23/32	.14
830-210SR	1-1/2x3/4	2-7/8	2-7/16	1-3/8	1-7/32	.28
830-211SR	1-1/2x1	2-15/16	2-7/16	1-11/16	7/16	.35
830-212SR	1-1/2x1-1/4	2-7/8	2-1/2	2-3/32	15/16	.33
830-249SR	2x1	3-3/16	3	1-23/32	1-17/32	.46
830-251SR	2x1-1/2	3-1/4	3	2-7/16	1-7/16	.43

GROOVED COUPLING ADAPTER

Groove x Socket

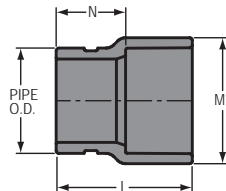

Part Number	Size	L	M1	N	Approx. Wt. (Lbs.)
833-012	1-1/4	2-13/16	2-1/16	1-9/16	.18
833-015	1-1/2	2-29/32	2-11/32	1-1/2	.19
833-020	2	3-1/16	2-7/8	1-9/16	.29
833-025	2-1/2	3-3/8	3-1/2	1-5/8	.49
833-030	3	3-9/16	4-3/16	1-11/16	.68

Schedule 80 PVC Technical Information
Schedule 80 Fittings



GROOVED COUPLING ADAPTER

Groove x Socket

(continued)

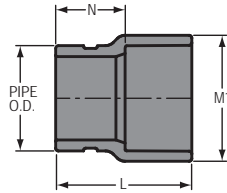

Part Number	Size	L	M1	N	Approx. Wt. (Lbs.)
833-040	4	4-17/32	5-1/4	2-9/32	1.28
833-050F	5	7	6-5/16	4	2.14
833-060	6	5-5/16	7-9/16	2-5/16	2.78
833-080F	8	8-3/16	9-5/8	3-15/16	6.19
833-100F	10	9-7/8	11-15/16	4-5/8	10.62
833-120F	12	10-7/8	14-1/8	4-5/8	21.92

RISER EXTENSION

Fipt x Mipt

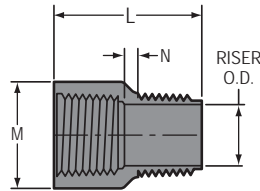

Part Number	Size	L	M	N	Approx. Wt. (Lbs.)
834-007	3/4	2-13/16	1-7/16	1-15/32	.11



FEMALE ADAPTER

Socket x Fipt

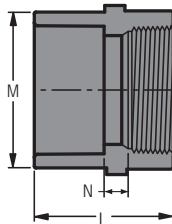

Part Number	Size	L	M	N	Approx. Wt. (Lbs.)
835-002	1/4	1-11/32	27/32	3/32	.02
835-003	3/8	1-15/32	1	3/32	.04
835-005	1/2	1-3/4	1-5/32	3/32	.05
835-007	3/4	1-27/32	1-13/32	3/32	.07
835-010	1	2-1/8	1-23/32	3/32	.11
835-012	1-1/4	2-5/16	2-3/32	3/32	.16
835-015	1-1/2	2-1/2	2-11/32	3/32	.20
835-020	2	3	3-1/32	1/4	.41
835-025	2-1/2	3-1/4	3-9/16	7/32	.63
835-030	3	3-15/32	4-1/4	3/16	.74
835-040	4	3-31/32	5-7/32	1/4	1.19
835-060	6	4-31/32	7-21/32	5/16	3.12
835-080	8	6-5/32	9-23/32	1/4	5.19
835-080F	8	8-9/16	9-5/8	2-9/16	6.19
835-100F	10	10-1/4	11-15/16	3	10.88
835-120F	12	11-1/8	14-1/8	2-5/8	16.56



Schedule 80 PVC Technical Information
Schedule 80 Fittings

SPECIAL REINFORCED FEMALE ADAPTER

Socket x SR Fipt

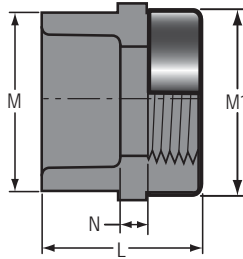

Part Number	Size	L	M	M1	N	Approx. Wt. (Lbs.)
835-002SR	1/4	1-13/32	27/32	27/32	3/32	.03
835-003SR	3/8	1-15/32	15/16	31/32	3/32	.04
835-005SR	1/2	1-3/4	1-5/32	1-3/16	3/16	.06
835-007SR	3/4	1-7/8	1-13/32	1-3/8	3/32	.08
835-010SR	1	2-1/8	1-11/16	1-23/32	3/32	.13
835-012SR	1-1/4	2-5/16	2-3/32	2-1/16	3/32	.18
835-015SR	1-1/2	2-7/16	2-13/32	2-7/16	7/32	.26
835-020SR	2	2-23/32	3	3-1/32	1/4	.44
835-025SR	2-1/2	3-1/4	3-9/16	3-9/16	11/32	.68
835-030SR	3	3-1/2	4-1/4	4-9/32	7/32	.96
835-040SR	4	3-31/32	5-7/32	5-1/4	7/32	1.29
835-060SR	6	4-31/32	7-5/8	7-21/32	1/4	3.17

REDUCING FEMALE ADAPTER

Socket x SR Fipt

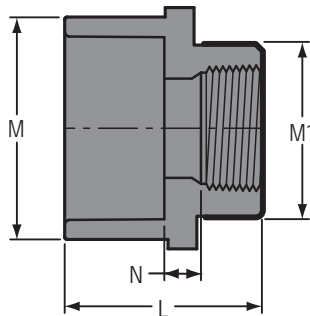

Part Number	Size	L	M	M1	N	Approx. Wt. (Lbs.)
835-098	3/4x1/4	1-15/16	1-13/32	27/32	---	.06

Schedule 80 PVC Technical Information
Schedule 80 Fittings



**SPECIAL REINFORCED
REDUCING FEMALE ADAPTER**

Socket x SR Fipt

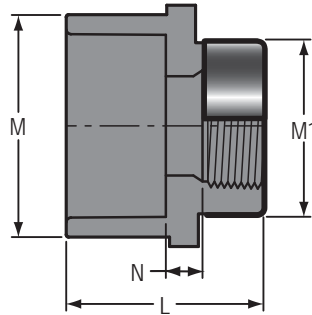

Part Number	Size	L	M	M1	N	Approx. Wt. (Lbs.)
835-074SR	1/2x3/4	1-3/4	1-3/16	1-3/8	7/32	.07
835-098SR	3/4x1/4	1-15/16	1-13/32	27/32	13/32	.06
835-101SR	3/4x1/2	1-7/8	1-3/8	1-3/16	3/16	.07
835-102SR	3/4x1	2-1/16	1-7/16	1-11/16	7/32	.12
835-130SR	1x1/2	2	1-11/16	1-3/16	7/32	.10
835-131SR	1x3/4	2-3/32	1-3/4	1-3/8	1/4	.12



TRANSITION FEMALE ADAPTER

Socket x Brass Fipt

Dimensions Also Applicable to 835-XXXSS

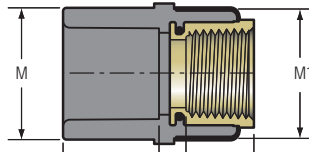

Part Number	Size	L	M	M1	N	Approx. Wt. (Lbs.)
835-005BR	1/2	1-25/32	1-5/32	1-7/32	5/8	.11
835-007BR	3/4	2	1-13/32	1-3/8	3/8	.23
835-010BR	1	2-7/32	1-3/4	1-11/16	13/32	.25
835-012BR	1-1/4	2-3/8	2-3/32	2-1/16	3/8	.35
835-015BR	1-1/2	2-17/32	2-13/32	2-7/16	13/32	.46
835-020BR	2	2-25/32	2-7/8	3-3/16	7/16	1.03

Not intended to convey or dispense water for human consumption through drinking or cooking

**TRANSITION REDUCING
FEMALE ADAPTER**

Socket x Brass Fipt

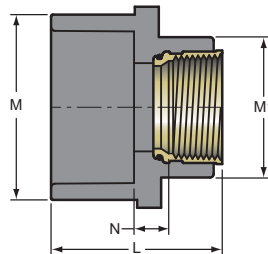

Part Number	Size	L	M	M1	N	Approx. Wt. (Lbs.)
835-101BR	3/4x1/2	2-1/32	1-7/16	1-3/16	15/32	.17

Not intended to convey or dispense water for human consumption through drinking or cooking



Schedule 80 Fittings

ENCAPSULATED SPECIAL REINFORCED FEMALE ADAPTER

Socket x ESR Fipt

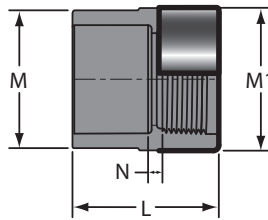

Part Number	Size	L	M	M1	N	Approx. Wt. (Lbs.)
835-002ESR	1/4	1-1/2	27/32	29/32	3/32	.04
835-003ESR	3/8	1-17/32	15/16	1-1/32	3/16	.04
835-005ESR	1/2	1-7/8	1-3/16	1-9/32	9/32	.08
835-007ESR	3/4	2	1-13/32	1-15/32	1/8	.10
835-010ESR	1	2-1/4	1-3/4	1-13/16	1/8	.13
835-012ESR	1-1/4	2-7/16	2-1/8	2-5/32	3/16	.21
835-015ESR	1-1/2	2-9/16	2-13/32	2-1/2	1/4	.29
835-020ESR	2	2-27/32	3	3-3/32	13/32	.46

MALE ADAPTER

Spigot x Mipt

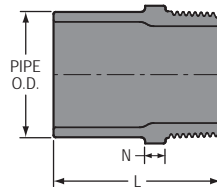

Part Number	Size	L	N	Approx. Wt. (Lbs.)
861-005	1/2	1-13/16	5/16	.03
861-007	3/4	1-31/32	5/16	.05
861-010	1	2-3/32	1/4	.07
861-131	1x3/4	2	1/4	.07
861-012	1-1/4	2-9/32	9/32	.11
861-015	1-1/2	2-5/8	11/32	.15
861-020	2	2-13/16	13/32	.23

SPECIAL REINFORCED SPIGOT FEMALE ADAPTER

Spigot x SR Fipt

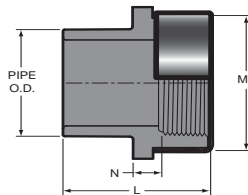

Part Number	Size	L	M1	N	Approx. Wt. (Lbs.)
878-005SR	1/2	1-3/4	1-3/16	5/32	.05
878-007SR	3/4	1-15/16	1-3/8	3/16	.07
878-010SR	1	2-1/4	1-11/16	7/32	.13
878-012SR	1-1/4	2-15/32	2-1/16	1/4	.18
878-015SR	1-1/2	2-21/32	2-7/16	13/32	.25

Schedule 80 PVC Technical Information
Schedule 80 Fittings



SPECIAL REINFORCED SPIGOT FEMALE ADAPTER (continued)

Spigot x SR Fipt

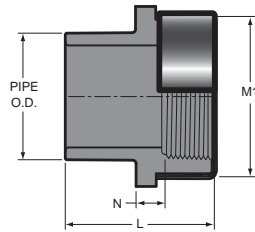

Part Number	Size	L	M1	N	Approx. Wt. (Lbs.)
878-020SR	2	2-13/16	3	3/8	.39
878-030SR	3	3-27/32	4-9/32	17/32	.91
878-040SR	4	4-3/8	5-1/4	5/8	1.36

SPECIAL REINFORCED REDUCING SPIGOT FEMALE ADAPTER

Spigot x SR Fipt

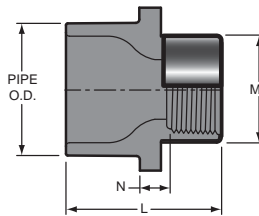

Part Number	Size	L	M1	N	Approx. Wt. (Lbs.)
878-072SR	1/2x1/4	1-13/32	27/32	3/16	.03
878-098SR	3/4x1/4	1-27/32	27/32	7/32	.05
878-128SR	1x1/4	2-3/8	27/32	21/32	.08



ENCAPSULATED SPECIAL REINFORCED SPIGOT FEMALE ADAPTER

Spigot x ESR Fipt

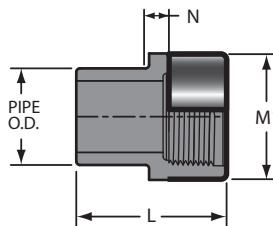

Part Number	Size	L	M1	N	Approx. Wt. (Lbs.)
878-005ESR	1/2	1-7/8	1-9/32	3/16	.06
878-007ESR	3/4	2-1/16	1-15/32	3/8	.09
878-010ESR	1	2-3/8	1-25/32	11/32	.14
878-012ESR	1-1/4	2-19/32	2-5/32	5/16	.20
878-015ESR	1-1/2	2-3/4	2-1/2	13/32	.27
878-020ESR	2	2-15/16	3-3/32	5/16	.41



Schedule 80 PVC Technical Information
Schedule 80 Fittings

TRANSITION FEMALE ADAPTER

Spigot x Brass Fipt

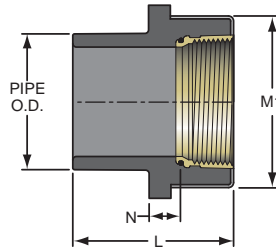

Part Number	Size	L	M1	N	Approx. Wt. (Lbs.)
878-005BR	1/2	1-15/16	1-3/16	1/2	.11
878-007BR	3/4	2-5/32	1-3/8	17/32	.14
878-010BR	1	2-9/32	1-23/32	13/32	.22

Not intended to convey or dispense water for human consumption through drinking or cooking

MALE ADAPTER

Mipt x Socket

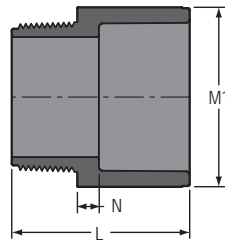

Part Number	Size	L	M1	N	Approx. Wt. (Lbs.)
836-005	1/2	1-23/32	1-5/32	3/16	.04
836-007	3/4	1-27/32	1-7/16	7/32	.06
836-010	1	2-5/32	1-23/32	7/32	.10
836-012	1-1/4	2-1/4	2-1/8	1/32	.15
836-015	1-1/2	2-9/16	2-13/32	9/32	.19
836-020	2	2-7/8	2-7/8	5/16	.28
836-025	2-1/2	3-21/32	3-17/32	11/32	.52
836-030	3	3-7/8	4-1/4	3/8	.74
836-040	4	4-13/32	5-5/16	13/32	1.15
836-050F	5	6	6-5/16	1-5/8	2.07
836-060	6	5-1/2	7-9/16	19/32	2.89
836-080F	8	8-3/16	9-5/8	2-3/16	6.00
836-100F	10	10-3/8	11-15/16	3-3/16	10.95
836-120F	12	11-1/8	14-1/8	2-3/4	16.44

Schedule 80 PVC Technical Information
Schedule 80 Fittings



REDUCING MALE ADAPTER

Mipt x Socket

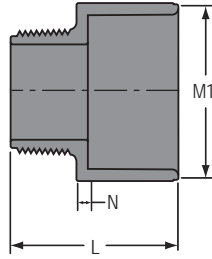

Part Number	Size	L	M1	N	Approx. Wt. (Lbs.)
836-053	3/8x1/2	1-11/16	1-3/16	1/4	.04
836-102	3/4x1	2-9/32	1-3/4	17/32	.10
836-131	1x3/4	2-1/16	1-13/32	1/4	.07
836-251 ¹	2x1-1/2	3-3/32	2-29/32	19/32	.43

¹Outlet sized with bushing



REINFORCED MALE ADAPTER

Rmipt x Socket

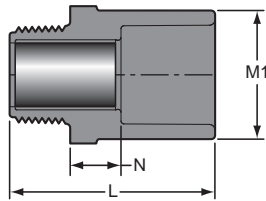

Part Number	Size	L	M1	N	Approx. Wt. (Lbs.)
836-005R	1/2	2-3/32	1-5/32	9/16	.05
836-007R	3/4	2-1/4	1-3/8	9/16	.08
836-010R	1	2-21/32	1-23/32	11/16	.15

TRANSITION MALE ADAPTER

Brass Mipt x Socket

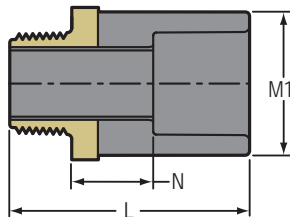

Part Number	Size	L	M1	N	Approx. Wt. (Lbs.)
836-005BR	1/2	2-13/32	1-9/32	27/32	.19
836-007BR	3/4	2-17/32	1-13/32	13/16	.26
836-010BR	1	2-15/16	1-23/32	29/32	.43
836-012BR	1-1/4	3-1/8	2-3/32	31/32	.66
836-015BR	1-1/2	3-9/32	2-11/32	1	.79
836-020BR	2	3-7/16	2-27/32	31/32	.99



Schedule 80 PVC Technical Information
Schedule 80 Fittings

REDUCER BUSHING

Flush Style

Spigot x Socket

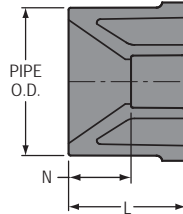

Part Number	Size	L	N	Approx. Wt. (Lbs.)
837-052	3/8x1/4	31/32	5/16	.01
837-072	1/2x1/4	1-3/32	13/32	.02
837-073	1/2x3/8	1-1/8	11/32	.01
837-101	3/4x1/2	1-7/32	11/32	.03
837-129 ¹	1x3/8	1-5/8	27/32	.09
837-130	1x1/2	1-11/32	11/32	.06
837-131	1x3/4	1-11/32	5/16	.04
837-166	1-1/4x1/2	1-1/2	5/8	.12
837-167	1-1/4x3/4	1-1/2	1/2	.10
837-168	1-1/4x1	1-19/32	15/32	.06
837-209	1-1/2x1/2	1-23/32	13/16	.15
837-210	1-1/2x3/4	1-5/8	5/8	.16
837-211	1-1/2x1	1-9/16	13/32	.13
837-212	1-1/2x1-1/4	1-9/16	9/32	.07
837-247	2x1/2	1-25/32	7/8	.24
837-248	2x3/4	1-29/32	21/32	.26
837-249	2x1	1-25/32	5/8	.24
837-250	2x1-1/4	1-11/16	7/16	.20
837-251	2x1-1/2	1-3/4	11/32	.15
837-287 ¹	2-1/2x1/2	2-1/2	1-1/2	.54
837-288 ¹	2-1/2x3/4	2-17/32	1-15/32	.55
837-289	2-1/2x1	2-1/32	29/32	.37
837-290	2-1/2x1-1/4	2-5/32	13/32	.43
837-291	2-1/2x1-1/2	2-5/32	3/4	.37
837-292	2-1/2x2	2-1/16	17/32	.23
837-334 ¹	3x3/4	2-9/16	1-17/32	.69
837-335	3x1	2-9/32	1-1/8	.69
837-336	3x1-1/4	2-1/4	1	.63
837-337	3x1-1/2	2-9/32	7/8	.59
837-338	3x2	2-7/32	23/32	.47
837-339	3x2-1/2	2-5/16	1/4	.37

¹ Outlet sized with bushing

Schedule 80 PVC Technical Information
Schedule 80 Fittings



REDUCER BUSHING (continued)

Flush Style

Spigot x Socket

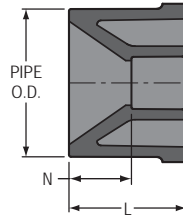

Part Number	Size	L	N	Approx. Wt. (Lbs.)
837-415 ¹	4x1/2	3-1/16	2-5/32	1.31
837-416 ¹	4x3/4	2-27/32	1-27/32	1.25
837-417 ¹	4x1	3-1/16	1-1/8	1.31
837-418 ¹	4x1-1/4	3-9/16	1-11/16	1.33
837-419	4x1-1/2	2-19/32	1-3/16	1.02
837-420	4x2	2-21/32	1-1/8	1.01
837-421	4x2-1/2	2-17/32	25/32	1.00
837-422	4x3	2-9/16	11/16	.84
837-490	5x4	2-31/32	23/32	1.29
837-490F	5x4	3	3/4	1.41
837-524 ¹	6x3/4	4-1/2	3-1/2	3.45
837-525 ¹	6x1	3-31/32	2-13/16	3.13
837-526 ¹	6x1-1/4	3-25/32	2-17/32	3.07
837-527 ¹	6x1-1/2	3-3/4	2-11/32	3.01
837-528	6x2	3-17/32	2-1/32	2.83
837-529 ¹	6x2-1/2	3-29/32	2-5/32	3.29
837-530	6x3	3-17/32	2-1/8	2.84
837-532	6x4	3-9/16	1-1/4	2.71
837-533F	6x5	3	3/8	1.76
837-534	6x5	3-1/2	7/8	1.93
837-578 ¹	8x2	4-15/16	3-3/8	8.64
837-580 ¹	8x3	5-1/8	3-1/4	8.68
837-582	8x4	4-1/2	2-1/4	5.53
837-585	8x6	4-3/8	1-3/8	5.05
837-624 ¹	10x4	6	3-3/4	10.56
837-626	10x6	5-5/16	2-5/16	9.32
837-628	10x8	5-11/32	1-5/16	9.04
837-666	12x6	7	4	15.51
837-666F	12x6	6-7/16	3-3/8	15.31
837-668	12x8	6-7/8	2-7/16	10.13
837-670	12x10	6-11/32	1-9/32	11.74

¹ Outlet sized with bushing





Schedule 80 Fittings

REDUCER BUSHING (continued)

Flush Style

Spigot x Socket

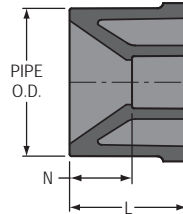

Part Number	Size	L	N	Approx. Wt. (Lbs.)
837-670F	12x10	6	1	11.04
837-696F	14x6	7-3/4	4-3/4	27.16
837-698F	14x8	7-1/2	3-7/16	32.31
837-700F	14x10	7-7/16	2-7/16	22.30
837-702F	14x12	7	1	9.36
837-756F	16x6	8-3/4	5-3/4	44.23
837-758F	16x8	8-1/2	4-7/16	46.90
837-760F	16x10	8-7/16	3-7/16	39.12
837-762F	16x12	8	2	28.08
837-764F	16x14	8	1	18.37
837-788F	18x8	9-1/2	5-7/16	70.33
837-790F	18x10	9-7/16	4-7/16	65.60
837-792F	18x12	9	3	51.82
837-794F	18x14	9	2	40.70
837-796F	18x16	9	1	32.00
837-818F	20x8	10-1/2	6-7/16	125.96
837-820F	20x10	10-7/16	5-7/16	94.18
837-822F	20x12	10	4	83.14
837-824F	20x14	10	3	73.74
837-826F	20x16	10	2	55.07
837-828F	20x18	10	1	30.35
837-910F	24x10	12-7/16	7-7/16	173.68
837-912F	24x12	12	6	159.41
837-914F	24x14	12	5	80.35
837-916F	24x16	12	4	134.57
837-918F	24x18	12	3	112.54
837-920F	24x20	12	2	79.50



Schedule 80 PVC Technical Information
Schedule 80 Fittings



REDUCER BUSHING

Flush Style

Spigot x Fipt

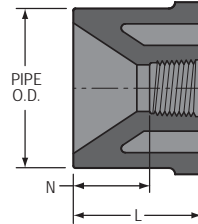

Part Number	Size	L	N	Approx. Wt. (Lbs.)
838-052	3/8x1/4	31/32	3/8	.01
838-071	1/2x1/8	1	9/16	.02
838-072	1/2x1/4	1	7/8	.02
838-073	1/2x3/8	1-3/32	17/32	.02
838-098	3/4x1/4	1-7/32	5/8	.04
838-099	3/4x3/8	1-1/4	21/32	.04
838-101	3/4x1/2	1-1/4	7/16	.03
838-127	1x1/8	1-13/32	29/32	.07
838-128	1x1/4	1-13/32	25/32	.07
838-129	1x3/8	1-13/32	19/32	.07
838-130	1x1/2	1-5/32	21/32	.06
838-131	1x3/4	1-3/8	21/32	.05
838-166	1-1/4x1/2	1-17/32	3/4	.12
838-167	1-1/4x3/4	1-7/16	23/32	.09
838-168	1-1/4x1	1-17/32	5/8	.07
838-206	1-1/2x1/8	1-11/16	1-1/4	.15
838-207	1-1/2x1/4	1-9/16	1-3/16	.13
838-209	1-1/2x1/2	1-11/16	31/32	.17
838-210	1-1/2x3/4	1-9/16	27/32	.13
838-211	1-1/2x1	1-23/32	13/16	.14
838-212	1-1/2x1-1/4	1-1/2	9/16	.07
838-247	2x1/2	1-29/32	1-5/32	.25
838-248	2x3/4	1-7/8	1-5/32	.26
838-249	2x1	1-29/32	1	.25



REDUCER BUSHING (continued)

Flush Style

Spigot x Fipt

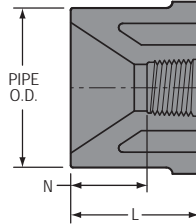

Part Number	Size	L	N	Approx. Wt. (Lbs.)
838-250	2x1-1/4	1-19/32	21/32	.18
838-251	2x1-1/2	1-9/16	5/8	.14
838-287	2-1/2x1/2	2-3/8	1-21/32	.41
838-288	2-1/2x3/4	2-7/16	1-5/8	.45
838-289	2-1/2x1	2-5/32	1-1/4	.42
838-290	2-1/2x1-1/4	2-13/32	1-3/8	.42
838-291	2-1/2x1-1/2	2-3/8	1-13/32	.47
838-292	2-1/2x2	2-1/16	1-1/16	.25
838-334	3x3/4	2-9/32	1-1/2	.57
838-335	3x1	2-9/32	1-11/32	.58
838-336	3x1-1/4	2-1/4	1-3/8	.57
838-337	3x1-1/2	2-1/4	1-5/8	.59
838-338	3x2	2-3/16	1-7/32	.63
838-339	3x2-1/2	2-3/8	3/4	.46
838-419	4x1-1/2	3-3/16	2-5/16	1.44
838-420	4x2	2-11/16	1-21/32	1.10
838-421	4x2-1/2	2-21/32	1-1/16	1.08
838-422	4x3	2-5/8	1	.86
838-528	6x2	3-17/32	2-1/2	2.92
838-530	6x3	3-17/32	2-1/8	2.98
838-532	6x4	3-17/32	2-1/32	2.54

Schedule 80 PVC Technical Information
Schedule 80 Fittings



**SPECIAL REINFORCED
REDUCER BUSHING**

Flush Style

Spigot x SR Fipt

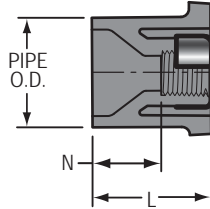

Part Number	Size	L	N	Approx. Wt. (Lbs.)
838-128SR	1x1/4	1-13/32	25/32	.08
838-166SR	1-1/4x1/2	1-7/16	3/4	.11
838-207SR	1-1/2x1/4	1-9/16	1	.13
838-209SR	1-1/2x1/2	1-23/32	31/32	.16
838-210SR	1-1/2x3/4	1-9/16	13/16	.14
838-247SR	2x1/2	1-29/32	1-5/32	.25
838-248SR	2x3/4	1-29/32	1-5/32	.26
838-249SR	2x1	1-7/8	31/32	.26
838-334SR	3x3/4	2-9/32	1-17/32	.58
838-335SR	3x1	2-9/32	1-11/32	.59
838-336SR	3x1-1/4	2-1/4	1-5/16	.57
838-337SR	3x1-1/2	2-1/4	1-3/8	.58
838-528SR	6x2	3-1/2	2-9/16	2.81
838-530SR	6x3	3-17/32	2-1/8	2.94
838-532SR	6x4	3-1/2	1-15/16	2.59



REDUCER T.T. BUSHING

Flush Style

Mipt x Fipt

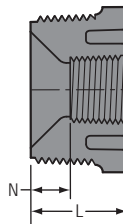

Part Number	Size	L	N	Approx. Wt. (Lbs.)
839-041	1/4x1/8	23/32	11/32	.01
839-052	3/8x1/4	13/16	1/8	.01



Schedule 80 PVC Technical Information
Schedule 80 Fittings

REDUCER T.T. BUSHING (continued)

Flush Style

Mipt x Fipt

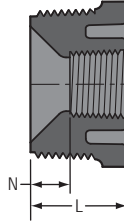

Part Number	Size	L	N	Approx. Wt. (Lbs.)
839-072	1/2x1/4	29/32	9/32	.02
839-073	1/2x3/8	15/16	11/32	.01
839-098	3/4x1/4	1-1/32	7/16	.03
839-099	3/4x3/8	1-1/32	7/16	.03
839-101	3/4x1/2	15/16	3/16	.02
839-128	1x1/4	1-1/8	17/32	.05
839-129	1x3/8	1-7/32	5/8	.05
839-130	1x1/2	1-1/16	5/16	.04
839-131	1x3/4	1-1/8	13/32	.04
839-166	1-1/4x1/2	1-5/16	9/16	.10
839-167	1-1/4x3/4	1-9/32	9/16	.08
839-168	1-1/4x1	1-3/16	9/32	.06
839-209	1-1/2x1/2	1-11/32	19/32	.12
839-210	1-1/2x3/4	1-11/32	19/32	.12
839-211	1-1/2x1	1-11/32	13/32	.10
839-212	1-1/2x1-1/4	1-11/32	13/32	.06
839-247	2x1/2	1-3/8	21/32	.17
839-248	2x3/4	1-3/8	5/8	.17
839-249	2x1	1-3/8	15/32	.18
839-250	2x1-1/4	1-3/8	7/16	.16
839-251	2x1-1/2	1-3/8	13/32	.12
839-292	2-1/2x2	1-29/32	7/8	.22
839-337	3x1-1/2	1-15/16	29/32	.49
839-338	3x2	1-15/16	15/16	.45
839-339	3x2-1/2	1-15/16	5/8	.37
839-420	4x2	2-1/8	1-1/8	.83
839-422	4x3	2-1/8	1/2	.71
839-532	6x4	3-17/32	1-13/16	2.53

Schedule 80 PVC Technical Information
Schedule 80 Fittings



**SPECIAL REINFORCED
REDUCER T.T. BUSHING**

Mipt x SR Fipt

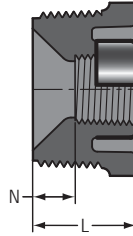

Part Number	Size	L	N	Approx. Wt. (Lbs.)
839-128SR	1x1/4	1-1/8	17/32	.05
839-209SR	1-1/2x1/2	1-11/32	19/32	.13
839-210SR	1-1/2x3/4	1-11/32	19/32	.12
839-247SR	2x1/2	1-3/8	21/32	.18
839-248SR	2x3/4	1-3/8	5/8	.18
839-249SR	2x1	1-3/8	15/32	.19
839-420SR	4x2	2-1/8	1-1/8	.88



CAP

Socket

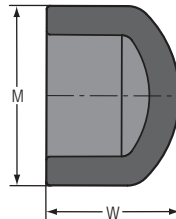

Part Number	Size	M	W	Approx. Wt. (Lbs.)
847-002	1/4	13/16	15/16	.01
847-003	3/8	31/32	1-1/8	.02
847-005	1/2	1-3/16	1-7/32	.03
847-007	3/4	1-3/8	1-13/32	.05
847-010	1	1-23/32	1-5/8	.08
847-012	1-1/4	2-3/32	1-27/32	.16
847-015	1-1/2	2-11/32	2	.16
847-020	2	2-7/8	2-1/4	.25
847-025	2-1/2	3-17/32	2-5/8	.48
847-030	3	4-5/32	3-1/32	.70
847-040	4	5-1/4	3-19/32	1.20
847-050F	5	6-1/2	4-7/16	1.83
847-060	6	7-1/2	4-7/8	3.17



Schedule 80 PVC Technical Information
Schedule 80 Fittings

CAP
 Socket (continued)

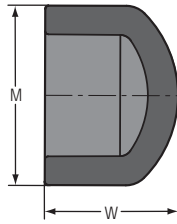

Part Number	Size	M	W	Approx. Wt. (Lbs.)
PVC				PVC
847-080	8	9-23/32	6-3/8	6.10
847-100F	10	12-1/4	5-15/16	8.26
847-120F	12	14-1/4	7-1/8	11.30
847-140F	14	15-1/2	7-3/8	14.65
847-160F	16	17-7/8	9	23.44
847-180F	18	19-15/16	9-1/4	28.88
847-200F	20	22	14-1/4	49.05
847-240F	24	26-3/8	17-1/4	89.38

CAP
 Fipt

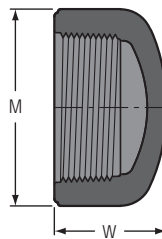

Part Number	Size	M	W	Approx. Wt. (Lbs.)
848-002	1/4	29/32	15/16	.02
848-003	3/8	31/32	29/32	.02
848-005	1/2	1-3/16	1-1/16	.04
848-007	3/4	1-3/32	1-7/32	.04
848-010	1	1-27/32	1-7/16	.10
848-012	1-1/4	2-7/32	1-17/32	.15
848-015	1-1/2	2-17/32	1-5/8	.19
848-020	2	3-5/32	1-25/32	.29
848-025	2-1/2	3-5/8	2-7/16	.54
848-030	3	4-3/8	2-7/16	.90
848-040	4	5-7/16	3-1/16	1.32
848-060F	6	7-3/16	4-3/8	2.07
848-080F	8	9-3/8	4-3/8	3.62
848-100F	10	11-5/8	5-3/4	7.44
848-120F	12	13-13/16	6-3/16	10.77

Schedule 80 PVC Technical Information
Schedule 80 Fittings



SPECIAL REINFORCED CAP

SR Fipt

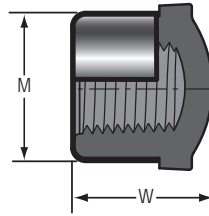

Part Number	Size	M	W	Approx. Wt. (Lbs.)
848-002SR	1/4	27/32	27/32	.02
848-003SR	3/8	31/32	29/32	.03
848-005SR	1/2	1-3/16	1-1/8	.04
848-007SR	3/4	1-3/8	1-3/32	.05
848-030SR	3	4-9/32	2-7/16	.79



PLUG

Spigot

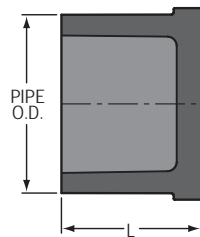

Part Number	Size	L	Approx. Wt. (Lbs.)
849-005	1/2	1-1/8	.02
849-007	3/4	1-1/4	.03
849-010	1	1-3/8	.06
849-012	1-1/4	1-17/32	.10
849-015	1-1/2	1-11/16	.13
849-020	2	1-7/8	.21
849-025F	2-1/2	5-3/8	1.10
849-030F	3	5-5/8	1.63
849-040F	4	6-1/2	2.76
849-060F	6	9	6.71
849-080F	8	12	12.73
849-100F	10	11-15/16	17.99
849-120F	12	14-1/8	26.34



Schedule 80 PVC Technical Information
Schedule 80 Fittings

PLUG

Mipt

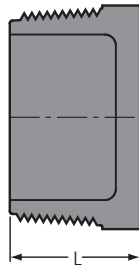

Part Number	Size	L	Approx. Wt. (Lbs.)
850-002	1/4	23/32	.01
850-003	3/8	13/16	.01
850-005	1/2	13/16	.02
850-007	3/4	7/8	.02
850-010	1	1-1/4	.06
850-012	1-1/4	1-9/32	.08
850-015	1-1/2	1-11/32	.10
850-020	2	1-3/8	.15
850-025	2-1/2	1-25/32	.30
850-030	3	1-7/8	.43
850-040	4	2-3/32	.77
850-060	6	2-3/32	1.73
850-080F	8	8-5/8	11.45
850-100F	10	8-7/16	12.91



Schedule 80 PVC Technical Information
Schedule 80 Fittings



WYE

Socket x Socket x Socket

1/2" - 2" 235 psi @ 73°F
 2-1/2" - 6" 150 psi @ 73°F
 8" & Up & All Fab 100 psi @ 73°F

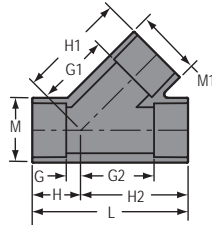

Part Number	Size	G	G1	G2	H	H1	H2	L	M	M1	Approx. Wt. (Lbs.)
875-005	1/2	1/4	1-5/32	1-5/32	1-1/8	2-1/16	2-1/32	3-3/16	1-5/32	1-5/32	.12
875-007	3/4	5/16	1-3/8	1-3/8	1-5/16	2-3/8	2-3/8	3-23/32	1-3/8	1-3/8	.19
875-010	1	5/16	1-3/4	1-3/4	1-7/16	2-29/32	2-7/8	4-11/32	1-11/16	1-11/16	.31
875-012	1-1/4	13/32	2-5/32	2-5/32	1-21/32	3-13/32	3-13/32	5-3/32	2-1/16	2-1/16	.50
875-015	1-1/2	17/32	2-1/2	2-1/2	1-29/32	3-7/8	3-7/8	5-13/16	2-5/16	2-5/16	.70
875-020	2	5/8	3-7/32	3-7/32	2-5/32	4-7/8	4-7/8	6-7/8	2-7/8	2-7/8	1.20
875-025	2-1/2	27/32	3-31/32	3-31/32	2-19/32	5-23/32	5-23/32	8-5/16	3-1/2	3-1/2	2.00
875-030	3	31/32	4-3/4	4-25/32	2-27/32	6-5/8	6-21/32	9-1/2	4-3/16	4-3/16	3.02
875-040	4	1-1/4	6-1/32	6-1/32	3-1/2	8-9/32	8-9/32	11-25/32	5-1/4	5-1/4	5.10
875-050F	5	5-1/8	10-11/16	10-11/16	8-1/8	13-11/16	13-11/16	21-13/16	6-5/16	6-5/16	9.34
875-060	6	1-5/32	8-25/32	8-3/16	4-3/16	11-25/32	11-3/16	15-3/8	7-9/16	7-9/16	12.01
875-080	8	1-15/16	11-11/32	11-11/32	5-31/32	15-11/32	15-11/32	21-5/16	9-3/4	9-3/4	25.44
875-080F	8	5-1/16	15-7/8	13-11/16	9-5/16	20-1/8	17-15/16	27-1/4	9-5/8	9-5/8	39.76
875-100F	10	6-1/2	18-7/8	17-1/4	11-3/4	24-1/8	22-1/2	34-1/4	11-15/16	11-15/16	65.51
875-120F	12	7-1/8	21-13/16	19-7/8	13-3/8	28-1/16	26-1/8	39-1/2	14-1/8	14-1/8	109.85
875-140F	14	9-13/16	23-13/16	23-13/16	16-13/16	30-13/16	30-13/16	47-5/8	15-1/2	15-1/2	135.75
875-160F	16	10-1/8	26-1/8	26-1/8	18-1/8	34-1/8	34-1/8	52-1/4	17-11/16	17-11/16	183.59
875-180F	18	10	29-3/8	28	19	38-3/8	37	56	19-7/8	19-7/8	255.49
875-200F	20	11-5/8	31-5/8	31-5/8	21-5/8	41-5/8	41-5/8	63-1/4	22-1/16	22-1/16	399.60
875-240F	24	14-1/4	38-1/4	38-1/4	26-1/4	50-1/4	50-1/4	76-1/2	26-7/16	26-7/16	617.50

¹ Outlet sized with bushing





Schedule 80 PVC Technical Information
Schedule 80 Fittings

REDUCING WYE

Socket x Socket x Socket

1/2" - 2-1/2" 235 psi @ 73°F
 3" - 6" 150 psi @ 73°F
 8" & Up & All Fab 100 psi @ 73°F

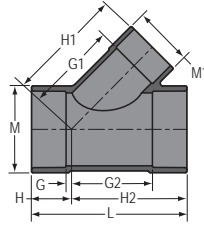

Part Number	Size	G	G1	G2	H	H1	H2	L	M	M1	Approx. Wt. (Lbs.)
875-131 ¹	1x1x3/4	1/4	2-7/32	1-27/32	1-3/8	2-31/32	2-31/32	4-11/32	1-11/16	1-11/16	.35
875-167 ¹	1-1/4x1-1/4x3/4	3/8	2-3/4	2-1/4	1-5/8	3-3/4	3-1/2	5-1/8	2-1/16	2-1/16	.61
875-168 ¹	1-1/4x1-1/4x1	3/8	2-5/8	2-1/4	1-5/8	3-3/4	3-1/2	5-1/8	2-1/16	2-1/16	.56
875-210 ¹	1-1/2x1-1/2x3/4	1/2	3-1/2	2-9/16	1-7/8	4-1/2	3-15/16	5-13/16	2-11/32	2-11/32	.88
875-211 ¹	1-1/2x1-1/2x1	1/2	3	2-9/16	1-7/8	4-5/32	3-15/16	5-13/16	2-11/32	2-11/32	.83
875-212 ¹	1-1/2x1-1/2x1-1/4	1/2	3-1/4	2-9/16	1-7/8	4-1/2	3-15/16	5-13/16	2-11/32	2-11/32	.74
875-248 ¹	2x2x3/4	5/8	4-5/32	3-7/32	2-5/32	5-5/32	4-7/8	6-7/8	2-7/8	2-7/8	1.46
875-250 ¹	2x2x1-1/4	5/8	3-5/16	3-3/8	2-5/32	5	4-3/4	6-7/8	2-7/8	2-7/8	1.46
875-291 ¹	2-1/2x2-1/2x1-1/2	1	6-1/4	4-9/16	3-1/16	7-5/8	6-5/8	9-11/16	4-3/16	4-3/16	4.34
875-292 ¹	2-1/2x2-1/2x2	1/2	3-3/4	4-3/4	2-1/2	6-7/8	6-1/2	9-3/8	4-1/4	4-1/4	3.97
875-335 ¹	3x3x1	11/16	5-7/8	4-7/32	2-9/16	6-15/16	6-1/8	8-23/32	4-3/16	4-3/16	3.27
875-336 ¹	3x3x1-1/4	7/8	5-3/4	4-1/8	2-3/4	7	6	8-3/4	4-3/16	4-3/16	3.21
875-337 ¹	3x3x1-1/2	2-5/8	5-1/2	4-1/4	2-5/8	6-7/8	6-1/8	8-3/4	4-3/16	4-3/16	3.14
875-338 ¹	3x3x2	1	5-11/32	4-3/4	2-7/8	6-31/32	6-5/8	9-1/2	4-3/16	4-3/16	3.48
875-339 ¹	3x3x2-1/2	7/8	4-1/8	4-21/32	2-3/4	6-3/4	6	8-3/4	4-3/16	4-3/16	2.97
875-419 ¹	4x4x1-1/2	1	6-5/8	5-1/4	3-1/4	8-13/16	7-1/2	10-3/4	5-1/4	5-3/16	6.04
875-420	4x4x2	-7/8	5-5/32	4-11/16	1-3/8	6-11/16	6-15/16	8-5/16	5-9/32	2-29/32	2.78
875-421F	4x4x2-1/2	4-9/16	8-13/16	9-1/16	6-13/16	10-1/2	11-5/16	18-1/8	5-1/4	3-1/2	5.37
875-422	4x4x3	1/2	5-7/16	5-7/32	2-3/4	7-5/16	7-15/32	10-7/32	5-1/4	4-3/16	3.98
875-528 ¹	6x6x2	1/16	8-13/16	6-9/16	3-1/16	10-5/16	9-9/16	12-5/8	7-9/16	5-7/16	9.78
875-528F	6x6x2	1-15/16	9-3/16	8-9/16	5-3/16	10-15/16	11-13/16	17	7-1/2	2-13/16	9.36
875-530 ¹	6x6x3	-1/16	8-3/8	6-11/16	3	10-1/4	9-11/16	12-5/8	7-9/16	5-3/8	9.60
875-530F	6x6x3	2-15/16	10-5/16	9-9/16	6-3/16	12-9/16	12-13/16	19	7-1/2	4-1/8	13.92
875-532	6x6x4	31/32	6-9/16	5-11/16	3-15/16	8-27/32	8-23/32	12-21/32	7-9/16	5-7/16	8.61
875-578 ¹	8x8x2	2	14-15/16	11-1/4	6	16-9/16	16-7/16	21-1/4	9-11/16	9-11/16	34.05
875-578F	8x8x2	7/8	10-1/2	9-1/2	5-1/8	12-1/4	13-3/4	18-7/8	9-5/8	2-13/16	17.93
875-579F	8x8x2-1/2	1-7/16	10-15/16	10-1/16	5-11/16	12-15/16	14-5/16	20	9-5/8	3-7/16	21.92
875-580F	8x8x3	1-15/16	11-5/8	10-9/16	6-3/16	13-7/8	14-13/16	21	9-5/8	4-1/8	21.92
875-582	8x8x4	11/16	9-1/8	8-1/4	3-5/16	11-3/8	12-1/4	15-9/16	9-3/4	5-1/4	14.60
875-582F	8x8x4	2-15/16	11-7/8	11-9/16	7-3/16	14-1/8	15-13/16	23	9-5/8	5-3/16	18.50
875-585 ¹	8x8x6	2	12-15/16	11-1/4	6	15-15/16	15-1/4	21-1/4	9-11/16	9-11/16	30.74
875-585F	8x8x6	4-15/16	13-15/16	13-9/16	9-3/16	17-3/16	17-13/16	27	9-5/8	7-1/2	32.97
875-621 ¹	10x10x2	3-3/4	6	14-1/2	9	17-1/2	19-3/4	28-3/4	11	7-1/2	30.84

¹Outlet sized with bushing

Schedule 80 PVC Technical Information
Schedule 80 Fittings



REDUCING WYE (continued)
Socket x Socket x Socket

1/2" - 2-1/2" 235 psi @ 73°F
3" - 6" 150 psi @ 73°F
8" & Up & All Fab 100 psi @ 73°F

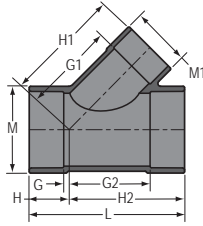

Part Number	Size	G	G1	G2	H	H1	H2	L	M	M1	Approx. Wt. (Lbs.)
875-621F	10x10x2	1/4	11-7/8	10-1/2	5	13-5/8	15-3/4	20-3/4	11-15/16	2-13/16	41.46
875-622F	10x10x2-1/2	1/8	12-5/16	10-7/8	5-3/8	14-5/16	16-1/8	21-1/2	11-15/16	3-7/16	29.34
875-623 ¹	10x10x3	7/8	12-7/8	11-5/8	6-1/8	15-1/4	16-7/8	23	12	4-1/8	30.70
875-623F	10x10x3	3/4	13	11-1/2	6	15-1/4	16-3/4	22-3/4	11-15/16	4-1/8	31.71
875-624 ¹	10x10x4	1-7/8	10-5/8	12-5/8	7-1/8	12-1/4	17-7/8	25	12	5-3/8	30.56
875-624F	10x10x4	1-3/4	13-1/4	12-1/2	7	15-1/2	17-3/4	24-3/4	11-15/16	5-3/16	39.93
875-626	10x10x6	-3/16	12	11	4-13/16	15	16	20-25/32	12-1/16	7-21/32	28.21
875-626F	10x10x6	3-3/4	15-5/16	14-1/2	9	18-9/16	19-3/4	28-3/4	11-15/16	7-1/2	42.69
875-628	10x10x8	1-7/32	12-3/4	12-1/4	6-7/32	16-25/32	17-9/32	23-1/2	12-1/32	9-23/32	34.14
875-628F	10x10x8	5-1/4	17-1/4	16	10-1/2	21-1/2	21-1/4	31-3/4	11-15/16	9-5/8	55.19
875-661F	12x12x2	1-5/16	13-3/16	11-7/16	4-15/16	14-15/16	17-11/16	22-5/8	14-1/8	2-13/16	37.58
875-662F	12x12x2-1/2	15/16	13-5/8	11-13/16	5-5/16	15-5/8	18-1/16	23-3/8	14-1/8	3-7/16	43.72
875-663F	12x12x3	1/8	14-5/16	12-7/8	6-3/8	16-9/16	19-1/8	25-1/2	14-1/8	4-1/8	43.39
875-664F	12x12x4	5/8	14-9/16	13-3/8	6-7/8	16-13/16	19-5/8	26-1/2	14-1/8	5-3/16	48.41
875-666F	12x12x6	2-5/8	16-5/8	15-3/8	8-7/8	19-7/8	21-5/8	30-1/2	14-1/8	7-1/2	64.52
875-668F	12x12x8	4-1/4	18-9/16	17	10-1/2	22-13/16	23-1/4	33-3/4	14-1/8	9-5/8	71.04
875-670F	12x12x10	5-3/4	20-3/16	18-1/2	12	25-7/16	24-3/4	36-3/4	14-1/8	11-15/16	80.79
875-694F	14x14x4	1-1/4	15-5/16	15-1/4	8-1/4	17-9/16	22-1/4	30-1/2	15-1/2	5-3/16	68.80
875-696F	14x14x6	2	17-3/8	16	9	20-5/8	23	32	15-1/2	7-1/2	78.50
875-698F	14x14x8	4-1/4	19-5/16	18-1/4	11-1/4	23-9/16	25-1/4	36-1/2	15-1/2	9-5/8	90.50
875-700F	14x14x10	5-3/4	20-15/16	19-3/4	12-3/4	26-3/16	26-3/4	39-1/2	15-1/2	11-15/16	84.58
875-702F	14x14x12	7-1/4	22-9/16	21-1/4	14-1/4	28-13/16	28-1/4	42-1/2	15-1/2	14-1/8	108.22
875-754F	16x16x4	1-1/8	16-5/8	17-1/8	9-1/8	18-7/8	25-1/8	34-1/4	17-11/16	5-3/16	76.47
875-756F	16x16x6	1-5/8	18-11/16	17-5/8	9-5/8	21-15/16	25-5/8	35-1/4	17-11/16	7-1/2	105.73
875-758F	16x16x8	3-5/8	20-5/8	19-5/8	11-5/8	24-7/8	27-5/8	39-1/4	17-11/16	9-5/8	120.00
875-760F	16x16x10	5-1/8	22-1/4	21-1/8	13-1/8	27-1/2	29-1/8	42-1/4	17-11/16	11-15/16	123.77
875-762F	16x16x12	6-1/2	23-7/8	22-1/2	14-1/2	30-1/8	30-1/2	45	17-11/16	14-1/8	142.80
875-764F	16x16x14	7-7/8	25-1/8	23-7/8	15-7/8	32-1/8	31-7/8	47-3/4	17-11/16	15-1/2	161.25
875-784F	18x18x4	0	17-7/8	18	9	20-1/8	27	36	19-7/8	5-3/16	116.63
875-786F	18x18x6	3/8	20-1/8	18-9/16	9-3/8	23-3/8	27-9/16	36-15/16	19-7/8	7-1/2	114.13
875-788F	18x18x8	3	21-7/8	21	12	26-1/8	30	42	19-7/8	9-5/8	92.20
875-790F	18x18x10	4-1/2	23-1/2	22-1/2	13-1/2	28-3/4	31-1/2	45	19-7/8	11-15/16	164.27
875-792F	18x18x12	6	25-1/8	24	15	31-3/8	33	48	19-7/8	14-1/8	184.56
875-794F	18x18x14	7	26-3/8	25	16	33-3/8	34	50	19-7/8	15-1/2	225.00
875-796F	18x18x16	8-1/2	27-3/8	26-1/2	17-1/2	35-3/8	35-1/2	53	19-7/8	17-11/16	225.00
875-814F	20x20x4	1	19-3/16	19	9	21-7/16	29	38	22-1/16	5-3/16	142.64
875-816F	20x20x6	1/8	21-1/4	19-7/8	9-7/8	24-1/2	29-7/8	39-3/4	22-1/16	7-1/2	156.65

¹ Outlet sized with bushing





Schedule 80 PVC Technical Information
Schedule 80 Fittings

REDUCING WYE (continued)

Socket x Socket x Socket

1/2" - 2-1/2" 235 psi @ 73°F
 3" - 6" 150 psi @ 73°F
 8" & Up & All Fab 100 psi @ 73°F

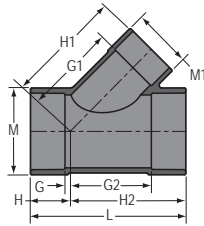

Part Number	Size	G	G1	G2	H	H1	H2	L	M	M1	Approx. Wt. (Lbs.)
875-816F	20x20x6	1/8	21-1/4	19-7/8	9-7/8	24-1/2	29-7/8	39-3/4	22-1/16	7-1/2	156.65
875-818F	20x20x8	2-5/8	23-3/16	22-5/8	12-5/8	27-7/16	32-5/8	45-1/4	22-1/16	9-5/8	173.00
875-820F	20x20x10	4-1/8	24-13/16	24-1/8	14-1/8	30-1/16	34-1/8	48-1/4	22-1/16	11-15/16	190.74
875-822F	20x20x12	5-5/8	26-7/16	25-5/8	15-5/8	32-11/16	35-5/8	51-1/4	22-1/16	14-1/8	237.50
875-824F	20x20x14	7-1/8	27-11/16	27-1/8	17-1/8	34-11/16	37-1/8	54-1/4	22-1/16	15-1/2	243.75
875-826F	20x20x16	8-1/2	28-11/16	28-1/2	18-1/2	36-11/16	38-1/2	57	22-1/16	17-11/16	250.00
875-828F	20x20x18	10-1/8	30-11/16	30-1/8	20-1/8	39-11/16	40-1/8	60-1/4	22-1/16	19-7/8	255.62
875-904F	24x24x4	3	21-3/4	21	9	24	33	42	26-7/16	5-3/16	230.78
875-906F	24x24x6	7/8	23-13/16	23-1/8	11-1/8	27-1/16	35-1/8	46-1/4	26-7/16	7-1/2	248.89
875-908F	24x24x8	1-3/4	25-3/4	25-3/4	13-3/4	30	37-3/4	51-1/2	26-7/16	9-5/8	269.27
875-910F	24x24x10	3-1/4	27-3/8	27-1/4	15-1/4	32-5/8	39-1/4	54-1/2	26-7/16	11-15/16	291.66
875-912F	24x24x12	4-3/4	29	28-3/4	16-3/4	35-1/4	40-3/4	57-1/2	26-7/16	14-1/8	264.99
875-914F	24x24x14	6-1/4	30-1/4	30-1/4	18-1/4	37-1/4	42-1/4	60-1/2	26-7/16	15-1/2	283.70
875-916F	24x24x16	7-3/4	31-1/4	31-3/4	19-3/4	39-1/4	43-3/4	63-1/2	26-7/16	17-11/16	310.60
875-918F	24x24x18	9-1/4	33-1/4	33-1/4	21-1/4	42-1/4	45-1/4	66-1/2	26-7/16	19-7/8	255.60
875-920F	24x24x20	9-5/8	34-3/16	33-5/8	21-5/8	44-3/16	45-5/8	67-1/4	26-7/16	22-1/16	372.56

DOUBLE WYE

Socket x Socket x Socket x Socket

100 psi @ 73°F

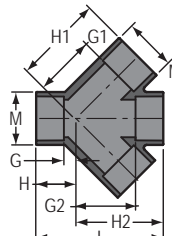

Part Number	Size	G	G1	G2	H	H1	H2	L	M	M1	Approx. Wt. (Lbs.)
876-020F	2	3-7/8	6-1/4	6-1/4	5-7/16	7-13/16	7-13/16	13-3/16	2-7/8	2-7/8	2.97
876-030F	3	4-3/4	8-1/8	8-1/4	6-5/8	10-3/16	10-3/16	16-13/16	4-3/16	4-3/16	6.48
876-040F	4	4-11/16	9-3/16	9-3/16	6-15/16	11-7/16	11-7/16	18-3/8	5-3/16	5-3/16	9.74
876-060F	6	4-15/16	12-5/8	11-9/16	8-3/16	15-7/8	14-13/16	23	7-1/2	7-1/2	25.44
876-080F	8	5-1/16	15-7/8	13-11/16	9-5/16	20-1/8	17-15/16	27-1/4	9-5/8	9-5/8	48.35
876-100F	10	6-1/2	18-7/8	17-1/4	11-3/4	24-1/8	22-1/2	34-1/4	11-15/16	11-15/16	65.51
876-120F	12	7-1/8	21-13/16	19-7/8	13-3/8	28-1/16	26-1/8	39-1/2	14-1/8	14-1/8	101.98

Schedule 80 PVC Technical Information
Schedule 80 Fittings



REDUCING DOUBLE WYE

Socket x Socket x Socket x Socket

3" - 6" 150 psi @ 73°F
 All Fab 100 psi @ 73°F

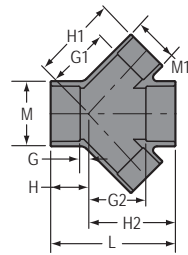

Part Number	Size	G	G1	G2	H	H1	H2	L	M	M1	Approx. Wt. (Lbs.)
876-338	3x2	3/8	4-1/4	4-13/32	2-1/4	5-3/4	5-29/32	8	4-3/16	2-7/8	2.24
876-421F	4x2-1/2	4-9/16	8-13/16	9-1/16	6-13/16	10-1/2	11-5/16	18-1/8	5-1/4	3-1/2	5.37
876-422F	4x3	4-11/16	10	9-3/16	6-15/16	11-13/16	11-7/16	18-3/8	5-3/16	5-3/16	13.87
876-528F	6x2	1-15/16	9-3/16	8-9/16	5-3/16	10-15/16	11-13/16	17	7-1/2	2-13/16	10.07
876-529F	6x2-1/2	2-7/16	9-5/8	9-1/16	5-11/16	11-5/8	12-5/16	18	7-1/2	3-7/16	13.21
876-530F	6x3	2-15/16	10-15/16	9-9/16	6-3/16	12-9/16	12-13/16	19	7-1/2	4-1/8	13.21
876-532F	6x4	3-15/16	10-9/16	10-9/16	7-3/16	12-13/16	13-13/16	21	7-1/2	5-3/16	18.77
876-578F	8x2	7/8	10-1/2	9-1/2	5-1/8	12-1/4	13-3/4	18-7/8	9-5/8	2-13/16	14.55
876-579F	8x2-1/2	1-7/16	10-15/16	10-1/16	5-11/16	12-15/16	14-5/16	20	9-5/8	3-7/16	21.92
876-580F	8x3	1-15/16	11-5/8	10-9/16	6-3/16	13-7/8	14-13/16	21	9-5/8	4-1/8	18.87
876-582F	8x4	2-15/16	11-7/8	11-9/16	7-3/16	14-1/8	15-13/16	23	9-5/8	5-3/16	20.88
876-585F	8x6	4-15/16	13-15/16	13-9/16	9-3/16	17-3/16	17-13/16	27	9-5/8	7-1/2	28.76
876-621F	10x2	1/4	11-7/8	10-1/2	5	13-5/8	15-3/4	20-3/4	11-15/16	2-13/16	26.48
876-622F	10x2-1/2	1/8	12-5/16	10-7/8	5-3/8	14-5/16	16-1/8	21-1/2	11-15/16	3-7/16	29.34
876-623F	10x3	3/4	13	11-1/2	6	15-1/4	16-3/4	22-3/4	11-15/16	4-1/8	22.67
876-624F	10x4	1-3/4	13-1/4	12-1/2	7	15-1/2	17-3/4	24-3/4	11-15/16	5-3/16	30.53
876-626F	10x6	3-3/4	15-5/16	14-1/2	9	18-9/16	19-3/4	28-3/4	11-15/16	7-1/2	40.05
876-628F	10x8	5-1/4	17-1/4	16	10-1/2	21-1/2	21-1/4	31-3/4	11-15/16	9-5/8	55.99
876-661F	12x2	1-5/16	13-3/16	11-7/16	4-15/16	14-15/16	17-11/16	22-5/8	14-1/8	2-13/16	37.58
876-662F	12x2-1/2	15/16	13-5/8	11-13/16	5-5/16	15-5/8	18-1/16	23-3/8	14-1/8	3-7/16	44.74
876-663F	12x3	1/8	14-5/16	12-7/8	6-3/8	16-9/16	19-1/8	25-1/2	14-1/8	4-1/8	43.39
876-664F	12x4	5/8	14-9/16	13-3/8	6-7/8	16-13/16	19-5/8	26-1/2	14-1/8	5-3/16	40.74
876-666F	12x6	2-5/8	16-5/8	15-3/8	8-7/8	19-7/8	21-5/8	30-1/2	14-1/8	7-1/2	68.02
876-668F	12x8	4-1/4	18-9/16	17	10-1/2	22-13/16	23-1/4	33-3/4	14-1/8	9-5/8	71.03
876-670F	12x10	5-3/4	20-3/16	18-1/2	12	25-7/16	24-3/4	36-3/4	14-1/8	11-15/16	80.79





Schedule 80 PVC Technical Information
Schedule 80 Unions

UNION (Old Style)

Socket x Socket

Dimensions Also Applicable to
897-XXX EPDM O-ring Seal Units

235 psi @ 73°F

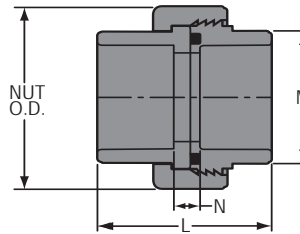

Part Number w/FKM O-ring Seal	Size	L	M	N	Nut O.D.	Approx. Wt. (Lbs.)
857-002	1/4	1-15/16	15/16	5/8	1-21/32	.09
857-003	3/8	2-5/32	1-1/32	19/32	1-25/32	.11
857-005	1/2	2-3/32	1-9/32	11/32	1-31/32	.15
857-007	3/4	2-3/8	1-17/32	11/32	2-1/2	.26
857-010	1	2-9/16	1-27/32	3/8	2-7/8	.37
857-012	1-1/4	2-7/8	2-7/32	3/8	3-5/16	.50
857-015	1-1/2	3-3/32	2-9/16	15/32	3-9/16	.60
857-020	2	3-5/8	3-1/32	9/16	4-3/16	.96
857-025	2-1/2	4-3/8	3-5/8	15/16	4-7/8	1.51
857-030	3	5-1/16	4-3/8	1-3/16	5-3/4	2.33
857-040	4	5-7/8	5-13/32	1-3/8	7-1/16	3.74

1) For (Socket X Socket) Unions Equipped With EPDM O-ring, Replace The 857 With An 897 Before The Dash.
 e.g. Part Number **897-002** = 1/4" PVC, Union, Socket x Socket, With EPDM O-rings.

UNION (Old Style)

Fipt x Fipt

Dimensions Also Applicable to
898-XXX EPDM O-ring Seal Units

235 psi @ 73°F

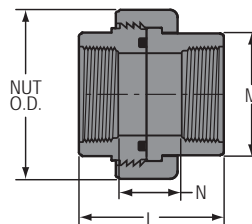

Part Number w/FKM O-ring Seal	Size	L	M	N	Nut O.D.	Approx. Wt. (Lbs.)
858-002	1/4	1-15/16	15/16	11/16	1-21/32	.10
858-003	3/8	2-5/32	1-1/32	15/16	1-25/32	.12
858-005	1/2	2-3/32	1-9/32	19/32	1-31/32	.16
858-007	3/4	2-3/8	1-17/32	3/4	2-1/2	.28

Schedule 80 PVC Technical Information
Schedule 80 Unions



UNION (Old Style) (continued)

Fipt x Fipt

Dimensions Also Applicable to
898-XXX EPDM O-ring Seal Units

235 psi @ 73°F

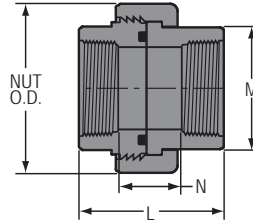

Part Number w/FKM O-ring Seal	Size	L	M	N	Nut O.D.	Approx. Wt. (Lbs.)
858-010	1	2-9/16	1-27/32	7/16	2-7/8	.39
858-012	1-1/4	2-7/8	2-7/32	7/8	3-5/16	.56
858-015	1-1/2	3-3/32	2-9/16	1-5/32	3-9/16	.65
858-020	2	3-5/8	3-1/32	1-11/16	4-3/16	1.05
858-025	2-1/2	4-3/8	3-5/8	1-7/8	4-7/8	1.67
858-030	3	5-1/16	4-3/8	1-13/16	5-3/4	2.51
858-040	4	5-7/8	5-7/16	2-3/8	7-1/16	4.07

1) For (Fipt X Fipt) Unions Equipped With EPDM O-ring, Replace The 858 With An 898 Before The Dash.
 e.g. Part Number **898-002** = 1/4" PVC, Union, Fipt x Fipt, With **EPDM** O-rings.



UNION (Old Style)

Socket x Fipt

Dimensions Also Applicable to
899-XXX EPDM O-ring Seal Units

235 psi @ 73°F

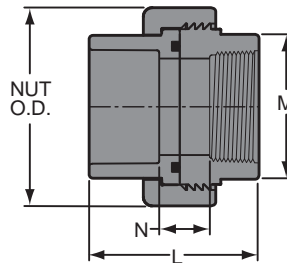

Part Number w/FKM O-ring Seal	Size	L	M	N	Nut O.D.	Approx. Wt. (Lbs.)
859-002	1/4	1-15/16	15/16	21/32	1-21/32	.08
859-003	3/8	2-5/32	1-1/32	3/4	1-25/32	.10
859-005	1/2	2-3/32	1-9/32	15/32	1-31/32	.16
859-007	3/4	2-3/8	1-17/32	9/16	2-1/2	.27
859-010	1	2-9/16	1-27/32	13/32	2-7/8	.38
859-012	1-1/4	2-7/8	2-7/32	5/8	3-5/16	.52
859-015	1-1/2	3-1/8	2-19/32	27/32	3-9/16	.63



Schedule 80 PVC Technical Information
Schedule 80 Unions

UNION (Old Style) (continued)

Socket x Fipt

Dimensions Also Applicable to
899-XXX EPDM O-ring Seal Units

235 psi @ 73°F

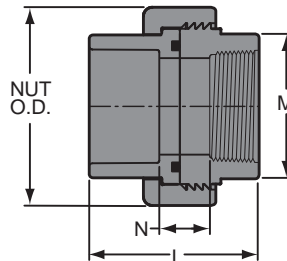

Part Number w/FKM O-ring Seal	Size	L	M	N	Nut O.D.	Approx. Wt. (Lbs.)
859-020	2	3-5/8	3-1/32	1-1/16	4-3/16	1.00
859-025	2-1/2	4-3/8	3-5/8	1-13/32	4-7/8	1.58
859-030	3	5-1/16	4-3/8	1-1/2	5-3/4	2.42
859-040	4	5-7/8	5-7/16	1-7/8	7-1/16	3.91

1) For (Socket X Fipt) Unions Equipped With EPDM O-ring, Replace The 859 With An 899 Before The Dash.
 e.g. Part Number **899-002** = 1/4" PVC, Union, Socket x Fipt, With **EPDM** O-rings.

TRANSITION UNION

Socket x Brass Fipt Threaded Insert and FKM O-ring Seal

Dimensions Also Applicable to **899-XXXBR EPDM O-ring Seal Units**

235 psi @ 73°F

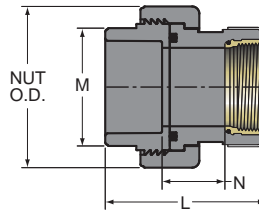

Part Number w/FKM O-ring Seal	Size	L	M	N	Nut O.D.	Approx. Wt. (Lbs.)
859-005BR	1/2	2-1/4	1-9/32	3/4	1-31/32	.21
859-007BR	3/4	2-11/16	1-17/32	15/16	2-1/2	.35
859-010BR	1	2-13/16	1-7/8	1-1/32	2-7/8	.52
859-012BR	1-1/4	3-9/32	2-7/32	1-1/16	3-5/16	.69
859-015BR	1-1/2	3-1/2	2-9/16	1-3/32	3-17/32	.89
859-020BR	2	3-5/8	2-7/8	1-1/4	4-5/16	1.60

Not intended to convey or dispense water for human consumption through drinking or cooking

1) For (Socket X Metal Fipt) Unions Equipped With EPDM O-ring, Replace The 859 With An 899 Before The Dash.
 e.g. Part Number **899-010BR** = 1" PVC, Union Socket x Metal Fipt With **EPDM** O-rings.

Schedule 80 PVC Technical Information
Schedule 80 Unions



SPECIAL REINFORCED UNION (Old style)

Socket x SR Fipt

Dimensions Also Applicable to

899-XXXSR EPDM O-ring Seal Units

235 psi @ 73°F

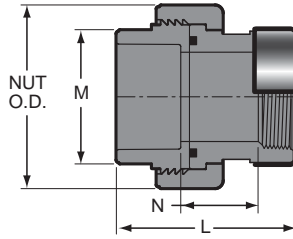

Part Number w/FKM O-ring Seal	Size	L	M	N	Nut O.D.	Approx. Wt. (Lbs.)
859-002SR	1/4	2-1/16	15/16	25/32	1-21/32	.09
859-003SR	3/8	2-9/32	1-1/32	29/32	1-25/32	.13
859-005SR	1/2	2-9/32	1-9/32	21/32	1-31/32	.17
859-007SR	3/4	2-19/32	1-17/32	25/32	2-1/2	.28
859-010SR	1	2-15/16	1-27/32	25/32	2-7/8	.40
859-012SR	1-1/4	3-5/32	2-7/32	29/32	3-5/16	.55
859-015SR	1-1/2	3-13/32	2-9/16	1-1/32	3-9/16	.67
859-020SR	2	4-3/32	3-1/32	1-19/32	4-3/16	1.12
859-030SR	3	5-1/4	4-3/8	1-11/16	5-3/4	2.50
859-040SR	4	5-7/8	5-13/32	2-1/8	7-3/32	3.96

1) For (Socket X SR Fipt) Unions Equipped With EPDM O-ring, Replace The 859 With An 899 Before The Dash.
 e.g. Part Number **899-002SR** = 1/4" PVC, Union, Socket x SR Fipt, With EPDM O-rings.

UNION 2000

Socket x Socket

Dimensions Also Applicable to

8097-XXX EPDM O-ring Seal Units

1/2" - 4" 235 psi @ 73°F
 6" 150 psi @ 73°F

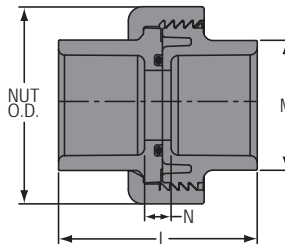

Part Number w/FKM O-ring Seal	Size	L	M	N	Nut O.D.	Approx. Wt. (Lbs.)
8057-005	1/2	2-3/32	1-3/16	11/32	1-7/8	.12
8057-007	3/4	2-3/8	1-13/32	3/8	2-9/32	.17
8057-010	1	2-11/16	1-23/32	7/16	2-9/16	.28
8057-012	1-1/4	2-15/16	2-3/32	7/16	3-3/32	.36



Schedule 80 PVC Technical Information
Schedule 80 Unions

UNION 2000 (continued)

Socket x Socket

Dimensions Also Applicable to
 8097-XXX EPDM O-ring Seal Units

1/2" - 4" 235 psi @ 73°F
 6" 150 psi @ 73°F

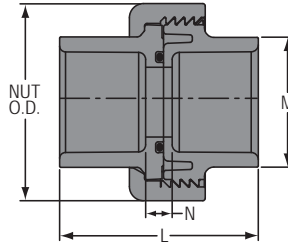

Part Number w/FKM O-ring Seal	Size	L	M	N	Nut O.D.	Approx. Wt. (Lbs.)
8057-015	1-1/2	3-1/4	2-3/8	1/2	3-1/2	.50
8057-020	2	3-17/32	2-7/8	17/32	4-9/32	.86
8057-025	2-1/2	4-7/32	3-1/2	25/32	6-5/32	2.14
8057-030	3	4-1/4	4-3/16	1/2	6-5/32	2.16
8057-040	4	5-1/8	5-1/4	5/8	7-3/4	3.75
8057-060	6	6-27/32	7-1/2	25/32	11-5/8	10.38

UNION 2000

Fipt x Fipt

Dimensions Also Applicable to
 8098-XXX EPDM O-ring Seal Units

1/2" - 4" 235 psi @ 73°F
 6" 150 psi @ 73°F

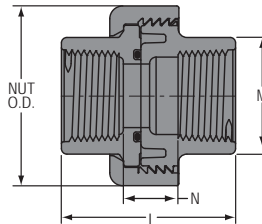

Part Number w/FKM O-ring Seal	Size	L	M	N	Nut O.D.	Approx. Wt. (Lbs.)
8058-005	1/2	1-29/32	1-3/16	17/32	1-7/8	.08
8058-007	3/4	2-1/16	1-3/8	9/16	2-9/32	.17
8058-010	1	2-17/32	1-11/16	25/32	2-9/16	.21
8058-012	1-1/4	2-21/32	2-1/32	3/4	3-1/8	.38
8058-015	1-1/2	2-25/32	2-3/8	29/32	3-1/2	.53
8058-020	2	3-1/8	3	1-3/16	4-7/32	.89
8058-025	2-1/2	4-1/32	3-9/16	1-15/32	6-5/32	1.67
8058-030	3	4-5/32	4-9/32	1-13/32	6-5/32	2.37
8058-040	4	4-21/32	5-1/4	1-21/32	7-3/4	3.59
8058-060	6	6-1/8	7-21/32	2-13/16	11-19/32	12.10

Schedule 80 PVC Technical Information
Schedule 80 Unions



SPECIAL REINFORCED UNION 2000

SR Fipt x SR Fipt

Dimensions Also Applicable to

8098-XXSR EPDM O-ring Seal Units

1/2" - 4" 235 psi @ 73°F
 6" 150 psi @ 73°F

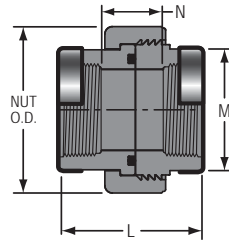

Part Number w/FKM O-ring Seal	Size	L	M	N	Nut O.D.	Approx. Wt. (Lbs.)
8058-005SR	1/2	2	1-3/16	5/8	1-7/8	.14
8058-007SR	3/4	2-5/32	1-3/8	21/32	2-9/32	.15
8058-010SR	1	2-9/16	1-11/16	13/16	2-9/16	.21
8058-012SR	1-1/4	2-23/32	2-1/32	13/16	3-1/8	.39
8058-015SR	1-1/2	2-27/32	2-13/32	29/32	3-17/32	.59
8058-020SR	2	3-7/32	3-1/32	1-3/16	4-7/32	.97
8058-025SR	2-1/2	4-3/32	3-9/16	1-15/32	6-5/32	1.66
8058-030SR	3	4-3/16	4-9/32	1-3/8	6-5/32	2.44
8058-040SR	4	4-11/16	5-1/4	1-11/16	7-3/4	3.73
8058-060SR	6	6-3/16	7-11/16	2-13/16	11-5/8	10.98



UNION 2000

Socket x Fipt

Dimensions Also Applicable to

8099-XXX EPDM O-ring Seal Units

1/2" - 4" 235 psi @ 73°F
 6" 150 psi @ 73°F

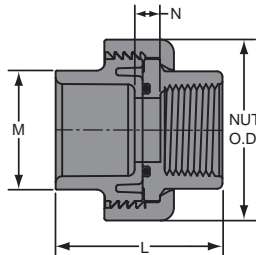

Part Number w/FKM O-ring Seal	Size	L	M	N	Nut O.D.	Approx. Wt. (Lbs.)
8059-005	1/2	1-7/8	1-3/16	5/16	1-7/8	.11
8059-007	3/4	2-1/16	1-13/32	5/16	2-9/32	.18
8059-010	1	2-13/32	1-23/32	13/32	2-9/16	.20
8059-012	1-1/4	2-19/32	2-3/32	13/32	3-1/8	.35
8059-015	1-1/2	2-13/16	2-3/8	1/2	3-1/2	.49



Schedule 80 PVC Technical Information
Schedule 80 Unions

UNION 2000 (continued)

Socket x Fipt

Dimensions Also Applicable to
 8099-XXX EPDM O-ring Seal Units

1/2" - 4" 235 psi @ 73°F
 6" 150 psi @ 73°F

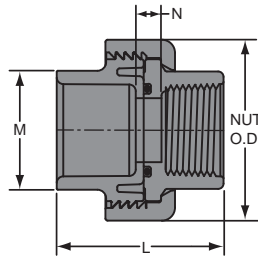

Part Number w/FKM O-ring Seal	Size	L	M	N	Nut O.D.	Approx. Wt. (Lbs.)
8059-020	2	2-31/32	2-7/8	13/32	4-9/32	.92
8059-025	2-1/2	3-15/32	3-1/2	13/32	6-3/16	1.58
8059-030	3	3-25/32	4-3/16	17/32	6-5/32	2.17
8059-040	4	4-3/8	5-1/4	5/8	7-3/4	3.64
8059-060	6	6-27/32	7-1/2	1-1/2	11-5/8	11.69

UNION 2000

Socket x SR Fipt

Dimensions Also Applicable to
 8099-XXXSR EPDM O-ring Seal Units

1/2" - 4" 235 psi @ 73°F
 6" 150 psi @ 73°F

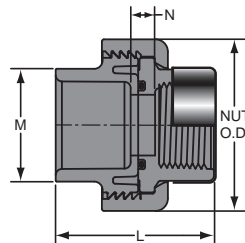

Part Number w/FKM O-ring Seal	Size	L	M	N	Nut O.D.	Approx. Wt. (Lbs.)
8059-005SR	1/2	1-29/32	1-3/16	11/32	1-7/8	.12
8059-007SR	3/4	2-5/32	1-13/32	13/32	2-9/32	.14
8059-010SR	1	2-7/16	1-23/32	7/16	2-9/16	.20
8059-012SR	1-1/4	2-5/8	2-3/32	7/16	3-1/8	.37
8059-015SR	1-1/2	2-13/16	2-3/8	1/2	3-1/2	.56
8059-020SR	2	3	2-7/8	7/16	4-7/32	1.00
8059-025SR	2-1/2	3-27/32	3-15/32	27/32	6-3/16	2.19
8059-030SR	3	3-3/4	4-3/16	1/2	6-9/32	2.24
8059-040SR	4	4-3/8	5-1/4	5/8	7-3/4	2.81
8059-060SR	6	6-27/32	7-1/2	2-5/32	11-5/8	11.50

Schedule 80 PVC Technical Information
Schedule 80 Unions



UNION 2000

Socket x Spigot

Dimensions Also Applicable to

8096-XXX EPDM O-ring Seal Units

1/2" - 4" 235 psi @ 73°F
 6" 150 psi @ 73°F

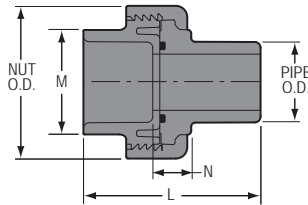

Part Number w/FKM O-ring Seal	Size	L	M	N	Nut O.D.	Approx. Wt. (Lbs.)
8056-005	1/2	2-5/16	1-3/16	9/16	1-7/8	.12
8056-007	3/4	2-5/8	1-3/8	21/32	2-9/32	.19
8056-010	1	2-15/16	1-23/32	5/8	2-9/16	.29
8056-012	1-1/4	3-7/32	2-3/32	11/16	3-3/16	.41
8056-015	1-1/2	3-1/2	2-3/8	11/16	3-9/16	.50
8056-020	2	3-3/4	2-7/8	3/4	4-5/16	.81
8056-025	2-1/2	4-21/32	3-15/32	1-5/32	6-5/32	2.23
8056-030	3	4-25/32	4-5/32	7/32	6-5/32	2.28
8056-040	4	5-5/8	5-1/4	1-1/8	7-23/32	3.95
8056-060	6	7-3/4	7-9/16	1-1/2	11-11/16	11.84



PVC TRANSITION UNION

DIN (mm) Socket x ASTM (in) Socket

Dimensions Also Applicable to 8697-XXX EPDM O-ring Units

235 psi @ 73°F
 (PN 16 @ 22°C)

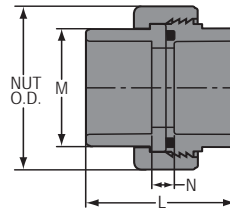

Part Number w/FKM O-ring Seal	Size	L	M	N	Nut O.D.	Approx. Wt. (Lbs.)
8657-020	20mm x 1/2	2-1/16	1-9/32	5/16	1-31/32	.16
8657-025	25mm x 3/4	2-11/32	1-17/32	11/32	2-1/2	.27
8657-032	32mm x 1	2-9/16	1-27/32	3/8	2-7/8	.37
8657-040	40mm x 1-1/4	2-7/8	2-7/32	3/8	3-5/16	.52
8657-050	50mm x 1-1/2	3-1/8	2-9/16	5/16	3-9/16	.59
8657-063	63mm x 2	3-5/8	3-1/32	9/16	4-3/16	.94
8657-090	90mm x 3	5-1/16	4-3/8	1-3/16	5-3/4	2.31
8657-110	110mm x 4	5-7/8	5-7/16	1-3/8	7-1/16	3.91

1) For DIN (mm) Socket X ASTM (in) Socket Unions Equipped with EPDM O-ring, Replace The 8657 With An 8697 Before The Dash.
 e.g. Part Number 8697-020 = 20mm x 1/2" PVC, Union Socket x Socket With EPDM O-rings.



Schedule 80 PVC Technical Information
Schedule 80 Unions

PVC TRANSITION UNION

DIN (mm) Socket x ASTM (in) Fipt

Dimensions Also Applicable to **8698-XXX** EPDM O-ring Seal Units

235 psi @ 73°F
 (PN 16 @ 22°C)

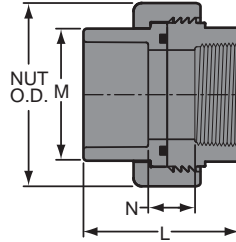

Part Number w/FKM O-ring Seal	Size	L	M	N	Nut O.D.	Approx. Wt. (Lbs.)
8658-020	20 mm x 1/2	2-3/32	1-9/32	19/32	1-31/32	.16
8658-025	25mm x 3/4	2-3/8	1-17/32	3/4	2-1/2	.28
8658-032	32mm x 1	2-9/16	1-27/32	7/16	2-7/8	.38
8658-040	40mm x 1-1/4	2-7/8	2-7/32	7/8	3-5/16	.56
8658-050	50mm x 1-1/2	3-3/32	2-9/16	1-5/32	3-9/16	.61
8658-063	63mm x 2	3-9/16	3-1/32	1-5/8	4-3/16	.99
8658-090	90mm x 3	5-1/16	4-3/8	1-13/16	5-3/4	2.41
8658-110	110mm x 4	5-7/8	5-7/16	2-3/8	7-1/16	4.07

1) For DIN (mm) Socket X NPT (in) Fipt Unions Equipped with EPDM O-ring, Replace The 8658 With An 8698 Before The Dash.
 e.g. Part Number **8698-020** = 20mm x 1/2" PVC, Union, DIN Socket x ASTM Fipt With **EPDM** O-rings.

PVC TRANSITION UNION

JIS (mm) Socket X ASTM (in) Socket

Dimensions Also Applicable to **8297-XXX** EPDM O-ring Seal Units

235 psi @ 73°F
 (PN 16 @ 22°C)

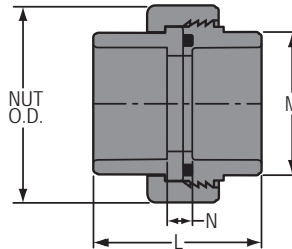

Part Number w/FKM O-ring Seal	Size	L	M	N	Nut O.D.	Approx. Wt. (Lbs.)
8257-016	16 DN x 1/2	2-1/16	1-9/32	5/16	1-31/32	.15
8257-020	20 DN x 3/4	2-3/8	1-17/32	5/16	2-1/2	.26
8257-025	25 DN x 1	2-9/16	1-27/32	3/8	2-7/8	.37
8257-030	30 DN x 1-1/4	2-15/16	2-3/32	7/16	3-3/16	.42
8257-040	40 DN x 1-1/2	3-1/8	2-9/16	5/16	3-9/16	.61
8257-050	50 DN x 2	3-5/8	3-1/32	9/16	4-3/16	.97
8257-075	75 DN x 3	5-1/16	4-3/8	1-3/16	5-3/4	2.34
8257-100	100 DN x 4	5-7/8	5-13/32	1-11/32	7-1/8	3.75

1) For JIS (mm) Socket X ASTM (in) Socket Unions Equipped with EPDM O-ring, Replace The 8257 With An 8297 Before The Dash.
 e.g. Part Number **8297-016** = 16mm x 1/2" PVC, Union, JIS Socket x ASTM Socket With **EPDM** O-rings.

Schedule 80 PVC Technical Information
Schedule 80 Unions



PVC TRANSITION UNION

JIS (mm) Socket X ASTM (in) Fipt

Dimensions Also Applicable to **8298-XXX** EPDM O-ring Seal Units

235 psi @ 73°F
 (PN 16 @ 22°C)

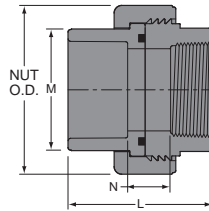

Part Number w/FKM O-ring Seal	Size	L	M	N	Nut O.D.	Approx. Wt. (Lbs.)
8258-016	16 DN x 1/2	2-3/32	1-9/32	19/32	1-31/32	.16
8258-020	20 DN x 3/4	2-3/8	1-17/32	3/4	2-1/2	.27
8258-025	25 DN x 1	2-25/32	1-23/32	13/16	2-21/32	.38
8258-030	30 DN x 1-1/4	2-7/8	2-7/32	7/8	3-5/16	.57
8258-040	40 DN x 1-1/2	3-1/8	2-17/32	25/32	3-17/32	.63
8258-050	50 DN x 2	3-11/16	2-7/8	1-7/32	4-9/32	1.02
8258-075	75 DN x 3	5-1/16	4-3/8	1-13/16	5-3/4	2.43
8258-100	100 DN x 4	5-7/8	5-7/16	2-3/8	7-1/16	3.96

1) For JIS (mm) Socket X ASTM (in) Fipt Unions Equipped with EPDM O-ring, Replace The 8258 With An 8298 Before The Dash.
 e.g. Part Number **8298-016** = 16dn x 1/2" PVC, Union, JIS Socket x ASTM Fipt With **EPDM** O-rings.

PVC TRANSITION UNION

BSP Threaded x ASTM (in) Socket

Dimensions Also Applicable to **8399-XXX** EPDM O-ring Seal Units

235 psi @ 73°F
 (PN 16 @ 22°C)

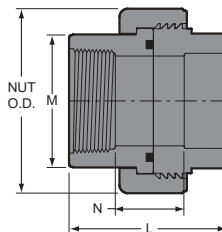

Part Number w/FKM O-ring Seal	Size	L	M	N	Nut O.D.	Approx. Wt. (Lbs.)
8359-005	1/2	1-29/32	1-3/16	13/32	1-15/16	.12
8359-007	3/4	2-3/8	1-17/32	9/16	2-1/2	.27
8359-010	1	2-9/16	1-27/32	13/32	2-7/8	.38
8359-012	1-1/4	2-5/8	2-1/4	7/16	3-3/16	.37
8359-015	1-1/2	3-3/32	2-9/16	23/32	3-9/16	.62
8359-020	2	3-1/32	3	17/32	4-1/4	.85
8359-030	3	5	4-3/8	1-11/16	5-25/32	2.43
8359-040	4	5-7/8	5-7/16	1-7/8	7-1/16	3.84

1) For BSP Threaded X ASTM (in) Socket Unions Equipped with EPDM O-ring, Replace The 8359 With An 8399 Before The Dash.
 e.g. Part Number **8399-005** = 1/2" PVC, Union, BSP Thread x ASTM Socket With **EPDM** O-rings.



Schedule 80 PVC Technical Information
Schedule 80 Unions

PVC TRANSITION UNION

BSP Threaded x ASTM (in.) Fipt
 Dimensions Also Applicable to
8398-XXX EPDM O-ring Seal Units

235 psi @ 73°F
 (PN 16 @ 22°C)

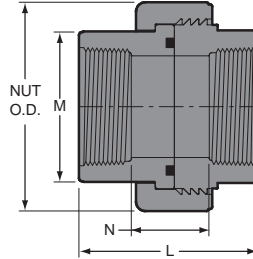

Part Number w/FKM O-ring Seal	Size	L	M	N	Nut O.D.	Approx. Wt. (Lbs.)
8358-005	1/2	2-3/32	1-9/32	19/32	1-31/32	.16
8358-007	3/4	2-3/8	1-17/32	27/32	2-1/2	.28
8358-010	1	2-9/16	1-27/32	7-16	2-7/8	.39
8358-012	1-1/4	2-23/32	2-1/32	27/32	3-3/16	.40
8358-015	1-1/2	3-3/32	2-9/16	1-5/32	3-9/16	.64
8358-020	2	3-9/16	3-1/32	1-5/8	4-3/16	1.05
8358-030	3	5-1/32	4-11/32	1-15/16	5-25/32	2.52
8358-040	4	5-7/8	5-7/16	2-3/8	7-1/16	4.00

1) For BSP Threaded X ASTM Fipt Unions Equipped with EPDM O-ring, Replace The 8358 With An 8398 Before The Dash.
 e.g. Part Number **8398-005** = 1/2" PVC, Union, BSP Thread x ASTM Fipt With **EPDM** O-rings.



CLAMP-ON SADDLES

Simple Two-Piece Design Engineered for Reliability



Spears® PVC Clamp-On Saddles allow quick, easy and reliable addition of branch lines to existing piping system lines. These versatile saddle units can be used in either temporary or permanent installations on all types of pipe with IPS (Iron Pipe size) outside diameter, such as PVC, CPVC, Polyethylene, Polypropylene and Steel.

Excellent Metal-to-Plastic System Transition

Easily installs on metal pipe as a transition to plastic system.

PVC Tee or Cross Configurations

Available in PVC White, PVC Gray in 2" - 12" IPS pipe saddle with socket outlets in sizes 1/2" - 6" and Special Reinforced (SR) threaded outlets in sizes 1/2" - 6", single Tee or double Cross configurations.

Patented SR Design Female Threads

Patented Special Reinforced (SR) design on female thread outlets for superior strength.

O-ring Options

Choice of high grade Buna-N or EPDM O-rings for Schedule 40 and EPDM or FKM O-rings for Schedule 80, for application specific selection for optimum chemical resistance.

Multi-Bolt Design, Choice of Hardware

Positive attachment eliminates splitting problems associated with plastic wedge fasteners and outperforms 2-Bolt clamp saddle designs. Choose zinc plated or stainless steel nut, bolt and washer hardware.

Excellent Pressure Capabilities

Maximum internal pressure rating of 235 psi through 4", 200 psi for 6", and 150 psi for 8" - 12" at 73°F.

Sample Engineering Specification

All thermoplastic saddles shall be clamp-on type with O-ring seal constructed from PVC Type I cell classification 12454. All O-rings shall be Buna-N, EPDM or FKM. All saddles shall be piloted at O-ring area for positive positioning in pipe. All bolt clamping hardware shall be zinc plated steel or stainless steel. All threaded saddle outlets shall be Special Reinforced (SR) design. Saddles shall be pressure rated at 235 psi for use on pipe sizes through 4" nominal IPS diameters, 200 psi for use on 6" pipe, and 150 psi for use on 8" - 12" pipe, maximum internal pressure for water at 73°F, as manufactured by Spears® Manufacturing Company.



Schedule 80 PVC Technical Information
Schedule 80 Saddles

Clamp-On Saddle Installation Instructions

1. Using a standard industrial grade hole-saw, cut specified hole in desired position on pipe according to recommended hole saw size engraved on the saddle. **Note:** Care must be taken to deburr hole and remove all residue from hole area to assure tight fit and avoid leakage.
2. Fully seat O-ring in groove on underside of saddle outlet component. Position over hole and fully seat saddle onto pipe. Note: Certain saddle outlets are piloted. Be sure pilot lip fully engages with hole in pipe.
3. Place strap component opposite outlet and secure with bolts (4), nuts (4) and washers (8). Important: Washers **MUST** be placed under each bolt head (1) and under each nut (1) to avoid damage to saddle.
4. Tighten bolts to specified torque.

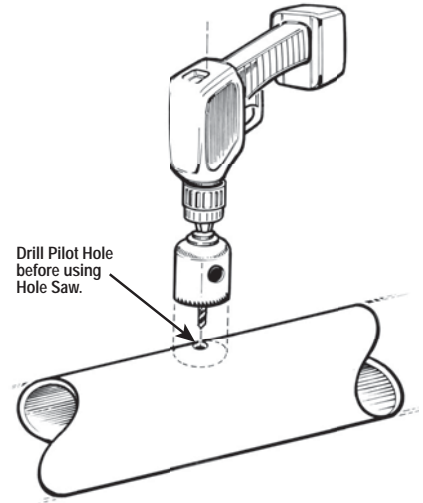

Saddle Size	2	3	4	6 & up
Recommended Bolt-Torque -ft/lb	8	8	8	10

O-ring seal provides positive, trouble-free sealing to pipe.

Special pilot engages with hole in pipe to prevent saddle dislocation.

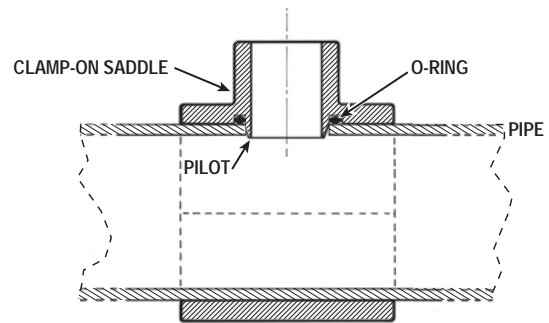
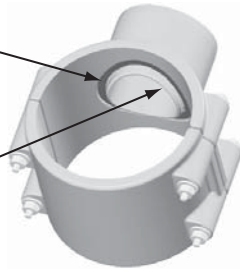

For Double Outlet Saddle Installation —Determine second outlet hole position as shown

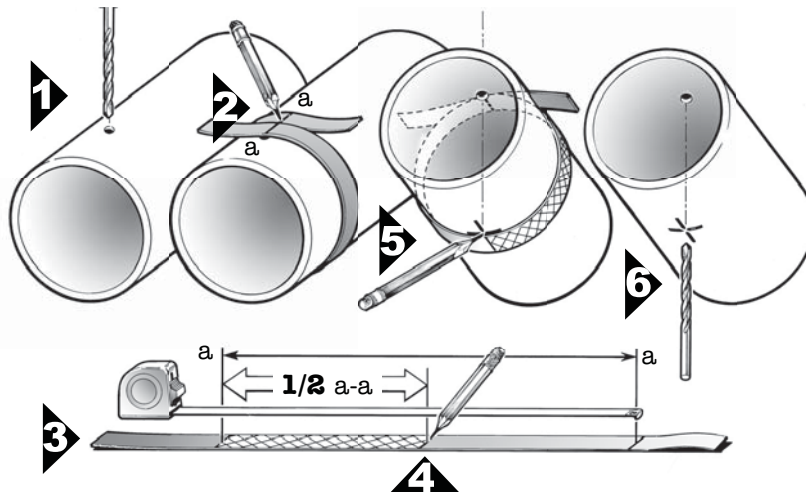

Schedule 80 PVC Technical Information
Schedule 80 Saddles



CLAMP ON SADDLE x SOCKET
SINGLE OUTLET

Dimensions Also Applicable to
 866S-XXX, 866V-XXX & 866SV-XXX

2" - 4" 235 psi @ 73°F
 6" 200 psi @ 73°F
 8" - 12" 150 psi @ 73°F

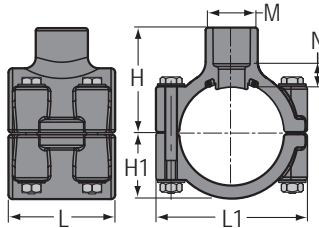

Part Number	Size	H	H1	L	L1	M	N	Hole Size	Bolt Torque ft./lbs.	Approx. Wt. (Lbs.)
866-247	2x1/2	2-3/8	1-1/2	2-7/16	3-7/16	1-3/16	5/16	3/4	8	.56
866-248	2x3/4	2-1/2	1-1/2	2-7/16	3-7/16	1-3/8	5/16	7/8	8	.57
866-249	2x1	2-5/8	1-1/2	2-7/16	3-7/16	1-11/16	5/16	1-1/8	8	.40
866-250	2x1-1/4	2-3/4	1-1/2	2-7/16	3-7/16	2-1/16	5/16	1-1/2	8	.68
866-251	2x1-1/2	2-15/16	1-1/2	2-7/16	3-7/16	2-3/8	5/16	1-1/2	8	.65
866-291	2-1/2x1-1/2	3-3/16	1-11/16	4-1/16	4	2-3/8	3/8	1-3/4	8	1.02
866-333 ¹	3x1/2	3-5/16	2-1/16	3	4-5/8	1-3/8	13/16	7/8	8	.88
866-334	3x3/4	3-1/16	2-1/16	3	4-5/8	1-3/8	9/32	7/8	8	.85
866-335	3x1	3-3/16	2-1/16	3	4-5/8	1-11/16	5/16	1-1/8	8	.91
866-336 ¹	3x1-1/4	4-1/32	2-1/16	4-3/32	4-5/8	3	1-1/32	2-1/4	8	1.48
866-337 ¹	3x1-1/2	4-1/32	2-1/16	4-3/32	4-5/8	3	29/32	2-1/4	8	1.41
866-338	3x2	3-5/8	2-1/16	4-3/32	4-5/8	3	3/8	2-1/4	8	1.24
866-415 ¹	4x1/2	4-3/32	2-5/8	3	5-9/16	2-3/8	31/32	1-1/8	8	1.31
866-416 ¹	4x3/4	4-3/32	2-5/8	3	5-9/16	2-3/8	27/32	1-1/8	8	1.29
866-417	4x1	3-13/16	2-5/8	3	5-5/8	1-11/16	7/16	1-1/8	8	1.24
866-418 ¹	4x1-1/4	4-13/32	2-5/8	4-3/32	5-5/8	2-3/8	29/32	1-3/4	8	1.70
866-419	4x1-1/2	4-1/8	2-5/8	4-3/32	5-9/16	2-3/8	1/2	1-3/4	8	1.63
866-420	4x2	4-3/16	2-5/8	4-1/8	5-5/8	3	7/16	2-1/4	8	1.69
866-421 ¹	4x2-1/2	5	2-5/8	5-7/16	5-23/32	4-9/32	3/4	3	8	2.78
866-422	4x3	4-5/8	2-19/32	5-7/16	5-11/16	4-1/4	1/2	3	8	2.39
866-523 ¹	6x1/2	5-13/32	3-7/8	3	7-3/4	1-11/16	1-7/32	1-1/8	10	2.35
866-524 ¹	6x3/4	5-7/16	3-7/8	3	7-3/4	1-11/16	1-1/8	1-1/8	10	2.33
866-525	6x1	5-1/8	3-7/8	3	7-15/16	1-11/16	11/16	1-1/8	10	2.29
866-526 ¹	6x1-1/4	5-15/16	3-7/8	4-1/8	7-3/4	3	1-3/8	2-1/4	10	3.28
866-527 ¹	6x1-1/2	5-15/16	3-7/8	4-1/8	7-3/4	3	1-1/4	2-1/4	10	3.22
866-528	6x2	5-1/2	3-7/8	4-1/8	7-3/4	3	11/16	2-1/4	10	3.04
866-529 ¹	6x2-1/2	6-7/16	3-7/8	6	7-15/16	4-1/4	1-1/8	3	10	4.73
866-530	6x3	5-15/16	3-7/8	6	7-15/16	4-1/4	25/32	3	10	4.35
866-532	6x4	6	3-29/32	6	7-15/16	5-3/16	5/8	4	10	5.09

¹ Outlet sized with bushing





Schedule 80 PVC Technical Information
Schedule 80 Saddles

CLAMP ON SADDLE x SOCKET (continued)
SINGLE OUTLET

Dimensions Also Applicable to
 866S-XXX, 866V-XXX & 866SV-XXX

2" - 4" 235 psi @ 73°F
 6" 200 psi @ 73°F
 8" - 12" 150 psi @ 73°F

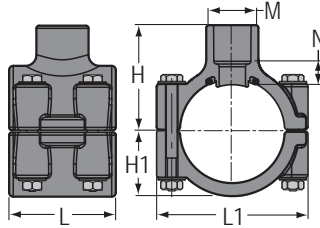

Part Number	Size	H	H1	L	L1	M	N	Hole Size	Bolt Torque ft./lbs.	Approx. Wt. (Lbs.)
866-573 ¹	8x1/2	7-3/4	4-7/8	9-1/2	8-1/2	5-5/16	1-1/2	4	10	9.70
866-574 ¹	8x3/4	8-3/32	4-7/8	8-1/2	10-1/8	5-1/4	2-3/4	4	10	9.65
866-575 ¹	8x1	8-3/32	4-7/8	8-1/2	10-1/8	5-1/4	2-5/8	4	10	9.67
866-576 ¹	8x1-1/4	8-3/32	4-7/8	8-1/2	10-1/8	5-1/4	2-1/2	4	10	9.79
866-577 ¹	8x1-1/2	8-3/32	4-7/8	8-1/2	10-1/8	5-1/4	2-3/8	4	10	10.23
866-578 ¹	8x2	7-11/16	4-7/8	8-1/2	10-1/8	5-1/4	1-7/8	4	10	10.28
866-579 ¹	8x2-1/2	8-5/32	4-7/8	8-15/32	10	5-7/32	2-1/2	4	10	9.43
866-580 ¹	8x3	7-11/16	4-7/8	8-1/2	10-1/8	5-1/4	1-7/16	4	10	10.21
866-582	8x4	7-5/16	4-7/8	8-1/2	10-1/8	5-1/4	11/16	4	10	12.22
866-585	8x6	8-3/32	4-7/8	8-1/2	10-1/8	7-5/8	11/16	6	10	9.80
866-621 ¹	10x2	8-7/8	6-1/32	8-1/2	12-5/16	5-1/4	1-15/16	4	10	13.02
866-624	10x4	8-15/32	6-1/32	8-1/2	12-5/16	5-1/4	13/16	4	10	11.92
866-626	10x6	9-9/32	6-1/32	8-1/2	12-5/16	7-5/8	13/16	6	10	12.92
866-664	12x4	9-9/16	7-5/32	8-1/2	14-5/16	5-1/4	7/8	4	10	15.47
866-666	12x6	10-3/8	7-5/32	8-1/2	14-5/16	7-5/8	7/8	6	10	16.33

¹ Outlet sized with bushing

- 1) Clamp On Saddle Standard Hardware: Zinc Bolts w/EPDM O-ring Seal
 e.g. Part Number 866-247 = 2x1/2 PVC Clamp On Saddle, Socket, EPDM O-ring, Zinc Bolts.
- 2) Clamp On Saddles w/Stainless Steel (SS) Bolts, Add The Letter "S" Before The Dash.
 e.g. Part Number 866S-247 = 2x1/2 PVC Clamp On Saddle, Socket, EPDM O-ring, Stainless Steel Bolts.
- 3) Clamp On Saddles w/FKM O-ring Seal, Add The Letter "V" Before The Dash.
 e.g. Part Number 866V-247 = 2x1/2 PVC Clamp-On Saddle, Socket, FKM O-ring, Zinc Bolts.
- 4) Clamp-On Saddles w/Stainless Steel Bolts & FKM O-ring Seal, Add The Letter "SV" Before The Dash.
 e.g. Part Number 866SV-247 = 2x1/2 PVC Clamp On Saddle, Socket FKM O-ring, Stainless Steel Bolts.

Schedule 80 PVC Technical Information
Schedule 80 Saddles



**CLAMP ON SADDLE x SR FIPT
 SINGLE OUTLET**

Dimensions Also Applicable to
 867S-XXXSR, 867V-XXXSR & 867SV-XXXSR

2" - 4" 235 psi @ 73°F
 6" 200 psi @ 73°F
 8" - 12" 150 psi @ 73°F

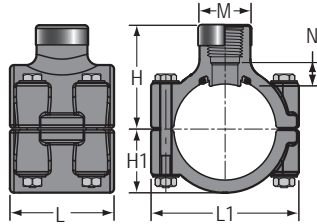

Part Number	Size	H	H1	L	L1	M	N	Hole Size	Bolt Torque ft./lbs.	Approx. Wt. (Lbs.)
867-247SR	2x1/2	2-3/8	1-1/2	2-7/16	3-7/16	1-3/16	5/16	3/4	3/4	.56
867-248SR	2x3/4	2-1/2	1-1/2	2-7/16	3-7/16	1-3/8	5/8	7/8	7/8	.57
867-249SR	2x1	2-5/8	1-1/2	2-7/16	3-7/16	1-11/16	9/16	1-1/8	1-1/8	.40
867-250SR	2x1-1/4	2-3/4	1-1/2	2-7/16	3-7/16	2-1/16	11/16	1-1/2	1-1/2	.61
867-251SR	2x1-1/2	2-15/16	1-1/2	2-7/16	3-7/16	2-3/8	3/4	1-1/2	1-1/2	.65
867-291SR	2-1/2x1-1/2	3-3/16	1-11/16	4-1/16	4	2-3/8	13/16	1-3/4	1-3/4	1.02
867-333SR ¹	3x1/2	3-5/16	2-1/16	3	4-5/8	1-3/8	15/16	7/8	7/8	.89
867-334SR	3x3/4	3-1/16	2-1/16	3	4-5/8	1-3/8	9/16	7/8	7/8	.87
867-335SR	3x1	3-3/16	2-1/16	3	4-5/8	1-11/16	9/16	1-1/8	1-1/8	.89
867-336SR ¹	3x1-1/4	4-1/32	2-1/16	4-3/32	4-5/8	3	1-5/16	2-1/4	2-1/4	1.51
867-337SR ¹	3x1-1/2	4-1/32	2-1/16	4-3/32	4-5/8	3	2-11/16	2-1/4	2-1/4	1.47
867-338SR	3x2	3-5/8	2-1/16	4-3/32	4-5/8	3	7/8	2-1/4	2-1/4	1.36
867-415SR ¹	4x1/2	4-3/32	2-5/8	3	5-9/16	2-3/8	1-1/8	1-1/8	1-1/8	1.32
867-416SR ¹	4x3/4	4-3/32	2-5/8	3	5-9/16	2-3/8	1-1/8	1-1/8	1-1/8	1.31
867-417SR	4x1	3-13/16	2-5/8	3	5-5/8	1-11/16	11/16	1-1/8	1-1/8	1.26
867-418SR ¹	4x1-1/4	4-13/32	2-5/8	4-3/32	5-5/8	2-3/8	1-7/32	1-3/4	1-3/4	1.75
867-419SR ¹	4x1-1/2	4-1/8	2-5/8	4-3/32	5-9/16	2-3/8	15/16	1-3/4	1-3/4	1.68
867-420SR	4x2	4-3/16	2-5/8	4-1/8	5-5/8	3	15/16	2-1/4	2-1/4	1.78
867-421SR ¹	4x2-1/2	5	2-5/8	5-7/16	5-23/32	4-9/32	1-7/32	3	3	2.91
867-422SR	4x3	4-5/8	2-19/32	5-7/16	5-11/16	4-1/4	31/32	3	3	2.53
867-523SR ¹	6x1/2	5-13/32	3-7/8	3	7-3/4	1-11/16	1-3/8	1-1/8	1-1/8	2.37
867-524SR ¹	6x3/4	5-7/16	3-7/8	3	7-3/4	1-11/16	1-3/8	1-1/8	1-1/8	2.35
867-525SR	6x1	5-1/8	3-7/8	3	7-15/16	1-11/16	15/16	1-1/8	1-1/8	2.31
867-526SR ¹	6x1-1/4	5-15/16	3-7/8	4-1/8	7-3/4	3	1-11/16	2-1/4	2-1/4	3.31
867-527SR ¹	6x1-1/2	5-15/16	3-7/8	4-1/8	7-3/4	3	1-3/4	2-1/4	2-1/4	3.27
867-528SR	6x2	5-1/2	3-7/8	4-1/8	7-3/4	3	1-7/32	2-1/4	2-1/4	3.13
867-529SR ¹	6x2-1/2	6-7/16	3-7/8	6	7-15/16	4-1/4	1-9/16	3	3	4.87
867-530SR	6x3	5-15/16	3-7/8	6	7-15/16	4-1/4	1-1/4	3	3	4.46
867-532SR	6x4	6	3-29/32	6	7-15/16	5-3/16	1-3/8	4	4	5.44

¹Outlet sized with bushing





Schedule 80 PVC Technical Information
Schedule 80 Saddles

**CLAMP ON SADDLE x SR FIPT
 SINGLE OUTLET**

(continued)

Dimensions Also Applicable to
 867S-XXXSR, 867V-XXXSR & 867SV-XXXSR

2" - 4" 235 psi @ 73°F
 6" 200 psi @ 73°F
 8" - 12" 150 psi @ 73°F

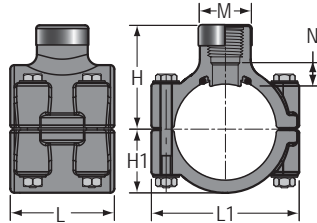

Part Number	Size	H	H1	L	L1	M	N	Hole Size	Bolt Torque ft./lbs.	Approx. Wt. (Lbs.)
867-573SR	8x1/2	8-3/32	4-7/8	8-1/2	10-1/8	5-1/4	3	4	10	9.69
867-574SR ¹	8x3/4	8-3/32	4-7/8	8-1/2	10-1/8	5-1/4	3	4	10	9.70
867-575SR	8x1	8-3/32	4-7/8	8-1/2	10-1/8	5-1/4	2-13/16	4	10	9.81
867-576SR ¹	8x1-1/4	9-5/16	4-15/16	8-9/16	9-29/32	5-7/32	1-19/32	4	10	9.68
867-577SR ¹	8x1-1/2	8-3/32	4-7/8	8-1/2	10-1/8	5-1/4	2-3/4	4	10	---
867-578SR ¹	8x2	7-11/16	4-7/8	8-1/2	10-1/8	5-1/4	2-3/8	4	10	---
867-579SR ¹	8x2-1/2	8-1/8	4-7/8	8-1/2	10-1/8	5-1/4	2-1/2	4	10	---
867-580SR ¹	8x3	7-11/16	4-7/8	8-1/2	10-1/8	5-1/4	1-15/16	4	10	---
867-582SR	8x4	7-5/16	4-7/8	8-1/2	10-1/8	5-1/4	1-1/2	4	10	7.74
867-585SR	8x6	8-3/32	4-7/8	8-1/2	10-1/8	7-5/8	2-3/32	6	10	8.61
867-624SR	10x4	8-15/32	6-1/32	8-1/2	12-5/16	5-1/4	2-3/16	4	10	---
867-626SR	10x6	9-9/32	6-1/32	8-1/2	12-5/16	7-5/8	3-3/16	6	10	---
867-664SR	12x4	9-9/16	7-5/32	8-1/2	14-5/16	5-1/4	1-5/8	4	10	---
867-666SR	12x6	10-3/8	7-5/32	8-1/2	14-5/16	7-5/8	2-1/4	6	10	---

¹ Outlet sized with bushing

- 1) Clamp On Saddle Standard Hardware: Zinc Bolts w/EPDM O-ring Seal
 e.g. Part Number 867-247SR = 2x1/2 PVC Clamp On Saddle, SR Threaded, EPDM O-ring, Zinc Bolts.
- 2) Clamp On Saddles w/Stainless Steel (SS) Bolts, Add The Letter "S" Before The Dash.
 e.g. Part Number 867S-247SR = 2x1/2 PVC Clamp On Saddle, SR Threaded, EPDM O-ring, Stainless Steel Bolts.
- 3) Clamp On Saddles w/FKM O-ring Seal, Add The Letter "V" Before The Dash.
 e.g. Part Number 867V-247SR = 2x1/2 PVC Clamp-On Saddle, SR Threaded, FKM O-ring, Zinc Bolts.
- 4) Clamp-On Saddles w/Stainless Steel Bolts & FKM O-ring Seal, Add The Letter "SV" Before The Dash.
 e.g. Part Number 867SV-247SR = 2x1/2 PVC Clamp On Saddle, SR Threaded FKM O-ring, Stainless Steel Bolts.

Schedule 80 PVC Technical Information
Schedule 80 Saddles



**CLAMP ON SADDLE x SOCKET
 DOUBLE OUTLET**

Dimensions Also Applicable to
 868S-XXX, 868V-XXX & 868SV-XXX

2" - 4" 235 psi @ 73°F
 6" 200 psi @ 73°F
 8" - 12" 150 psi @ 73°F

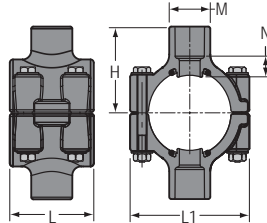

Part Number	Size	H	L	L1	M	N	Hole Size	Bolt Torque ft./lbs.	Approx. Wt. (Lbs.)
868-247	2x1/2	2-3/8	2-7/16	3-7/16	1-3/16	5/16	3/4	8	.56
868-248	2x3/4	2-1/2	2-7/16	3-7/16	1-3/8	5/16	7/8	8	.57
868-249	2x1	2-5/8	2-7/16	3-7/16	1-11/16	5/16	1-1/8	8	.40
838-250	2x1-1/4	2-3/4	2-7/16	3-7/16	2-1/16	5/16	1-1/2	8	.61
868-251	2x1-1/2	2-15/16	2-7/16	3-7/16	2-3/8	5/16	1-1/2	8	.65
868-291	2-1/2x1-1/2	3-3/16	4-1/16	4	2-3/8	3/8	1-3/4	8	1.02
868-333 ¹	3x1/2	3-5/16	3	4-5/8	1-3/8	13/16	7/8	8	.93
868-334	3x3/4	3-1/16	3	4-5/8	1-3/8	9/32	7/8	8	.89
868-335	3x1	3-3/16	3	4-5/8	1-11/16	5/16	1-1/8	8	.91
868-336 ¹	3x1-1/4	4-1/32	4-3/32	4-5/8	3	1-1/32	2-1/4	8	1.94
868-337 ¹	3x1-1/2	4-1/32	4-3/32	4-5/8	3	29/32	2-1/4	8	1.82
868-338	3x2	3-5/8	4-3/32	4-5/8	3	3/8	2-1/4	8	1.47
868-415 ¹	4x1/2	4-3/32	3	5-9/16	2-3/8	31/32	1-1/8	8	1.43
868-416 ¹	4x3/4	4-3/32	3	5-9/16	2-3/8	27/32	1-1/8	8	1.39
868-417	4x1	3-13/16	3	5-5/8	1-11/16	7/16	1-1/8	8	1.30
868-418 ¹	4x1-1/4	4-13/32	4-3/32	5-5/8	2-3/8	29/32	1-3/4	8	1.92
868-419	4x1-1/2	4-1/8	4-3/32	5-9/16	2-3/8	1/2	1-3/4	8	1.77
868-420	4x2	4-3/16	4-1/8	5-5/8	3	7/16	2-1/4	8	1.90
868-421 ¹	4x2-1/2	5	5-7/16	5-23/32	4-9/32	3/4	3	8	3.69
868-422	4x3	4-5/8	5-7/16	5-11/16	4-1/4	1/2	3	8	2.92
868-523 ¹	6x1/2	5-13/32	3	7-3/4	1-11/16	1-7/32	1-1/8	10	2.48
868-524 ¹	6x3/4	5-7/16	3	7-3/4	1-11/16	1-1/8	1-1/8	10	2.44
868-525	6x1	5-1/8	3	7-15/16	1-11/16	11/16	1-1/8	10	2.35
868-526 ¹	6x1-1/4	5-15/16	4-1/8	7-3/4	3	1-3/8	2-1/4	10	3.72
868-527 ¹	6x1-1/2	5-15/16	4-1/8	7-3/4	3	1-1/4	2-1/4	10	3.60
868-528	6x2	5-1/2	4-1/8	7-3/4	3	11/16	2-1/4	10	3.25
868-529 ¹	6x2-1/2	6-7/16	6	7-15/16	4-1/4	1-1/8	3	10	5.58
868-530	6x3	5-15/16	6	7-15/16	4-1/4	25/32	3	10	4.81
868-532	6x4	6	6	7-15/16	5-3/16	5/8	4	10	5.56
868-573 ¹	8x1/2	8-3/32	8-1/2	10-1/8	5-1/4	2-3/16	4	10	11.50

¹Outlet sized with bushing





Schedule 80 PVC Technical Information
Schedule 80 Saddles

CLAMP ON SADDLE x SOCKET (continued)
DOUBLE OUTLET

Dimensions Also Applicable to
 868S-XXX, 868V-XXX & 868SV-XXX

2" - 4" 235 psi @ 73°F
 6" 200 psi @ 73°F
 8" - 12" 150 psi @ 73°F

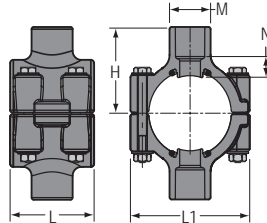

Part Number	Size	H	L	L1	M	N	Hole Size	Bolt Torque ft./lbs.	Approx. Wt. (Lbs.)
868-574 ¹	8x3/4	8-3/32	8-1/2	10-1/8	5-1/4	2-3/4	4	10	11.45
868-575 ¹	8x1	8-3/32	8-1/2	10-1/8	5-1/4	2-5/8	4	10	11.52
868-576 ¹	8x1-1/4	8-3/32	8-1/2	10-1/8	5-1/4	2-1/2	4	10	11.48
868-577 ¹	8x1-1/2	8-3/32	8-1/2	10-1/8	5-1/4	2-3/8	4	10	11.30
868-578 ¹	8x2	7-11/16	8-1/2	10-1/8	5-1/4	1-7/8	4	10	11.00
868-579 ¹	8x2-1/2	8-1/8	8-1/2	10-1/8	5-1/4	1-11/16	4	10	8.90
868-580 ¹	8x3	7-11/16	8-1/2	9-7/8	5-7/32	2-1/16	4	10	10.25
868-582	8x4	7-5/16	8-1/2	10-1/8	5-1/4	11/16	4	10	8.00
868-585	8x6	8-3/32	8-1/2	10-1/8	7-5/8	11/16	6	10	10.32
868-624	10x4	8-15/32	8-1/2	12-5/16	5-1/4	13/16	4	10	15.37
868-626	10x6	9-9/32	8-1/2	12-5/16	7-5/8	13/16	6	10	14.51
868-664	12x4	9-9/16	8-1/2	14-5/16	5-1/4	7/8	4	10	15.75
868-666	12x6	10-3/8	8-1/2	14-5/16	7-5/8	7/8	6	10	17.58

¹ Outlet sized with bushing

- 1) Clamp On Saddle Standard Hardware: Zinc Bolts w/EPDM O-ring Seal
 e.g. Part Number 868-247 = 2x1/2 PVC Clamp On Saddle, Socket, EPDM O-ring, Zinc Bolts.
- 2) Clamp On Saddles w/Stainless Steel (SS) Bolts, Add The Letter "S" Before The Dash.
 e.g. Part Number 868S-247 = 2x1/2 PVC Clamp On Saddle, Socket, EPDM O-ring, Stainless Steel Bolts.
- 3) Clamp On Saddles w/FKM O-ring Seal, Add The Letter "V" Before The Dash.
 e.g. Part Number 868V-247 = 2x1/2 PVC Clamp-On Saddle, Socket, FKM O-ring, Zinc Bolts.
- 4) Clamp-On Saddles w/Stainless Steel Bolts & FKM O-ring Seal, Add The Letter "SV" Before The Dash.
 e.g. Part Number 868SV-247 = 2x1/2 PVC Clamp On Saddle, Socket FKM O-ring, Stainless Steel Bolts.

Schedule 80 PVC Technical Information
Schedule 80 Saddles



CLAMP ON SADDLE x SR FIPT
DOUBLE OUTLET

Dimensions Also Applicable to
 869S-XXXSR, 869V-XXXSR & 869SV-XXXSR

2" - 4" 235 psi @ 73°F
 6" 200 psi @ 73°F
 8" - 12" 150 psi @ 73°F

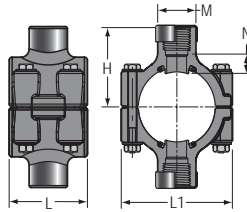

Part Number	Size	H	L	L1	M	N	Hole Size	Bolt Torque ft./lbs.	Approx. Wt. (Lbs.)
869-247SR	2x1/2	2-3/8	2-7/16	3-7/16	1-3/16	5/16	3/4	8	.56
869-248SR	2x3/4	2-1/2	2-7/16	3-7/16	1-3/8	5/8	7/8	8	.57
869-249SR	2x1	2-5/8	2-7/16	3-7/16	1-11/16	9/16	1-1/8	8	.40
869-250SR	2x1-1/4	2-3/4	2-7/16	3-7/16	2-1/16	11/16	1-1/2	8	.61
869-251SR	2x1-1/2	2-15/16	2-7/16	3-7/16	2-3/8	3/4	1-1/2	8	.65
869-291SR	2-1/2x1-1/2	3-3/16	4-1/16	4	2-3/8	13/16	1-3/4	8	1.02
869-333SR ¹	3x1/2	3-5/16	3	4-5/8	1-3/8	15/16	7/8	8	.96
869-334SR	3x3/4	3-1/16	3	4-5/8	1-3/8	9/16	7/8	8	.93
869-335SR	3x1	3-3/16	3	4-5/8	1-11/16	9/16	1-1/8	8	.95
869-336SR ¹	3x1-1/4	4-1/32	4-3/32	4-5/8	3	1-5/16	2-1/4	8	2.01
869-337SR ¹	3x1-1/2	4-1/32	4-3/32	4-5/8	3	2-11/16	2-1/4	8	1.93
869-338SR	3x2	3-5/8	4-3/32	4-5/8	3	7/8	2-1/4	8	1.71
869-415SR ¹	4x1/2	4-3/32	3	5-9/16	2-3/8	1-1/8	1-1/8	8	1.46
869-416SR ¹	4x3/4	4-3/32	3	5-9/16	2-3/8	1-1/8	1-1/8	8	1.43
869-417SR	4x1	3-13/16	3	5-5/8	1-11/16	11/16	1-1/8	8	1.34
869-418SR ¹	4x1-1/4	4-13/32	4-3/32	5-5/8	2-3/8	1-7/32	1-3/4	8	2.02
869-419SR	4x1-1/2	4-1/8	4-3/32	5-9/16	2-3/8	15/16	1-3/4	8	1.87
869-420SR	4x2	4-3/16	4-1/8	5-5/8	3	15/16	2-1/4	8	2.08
869-421SR ¹	4x2-1/2	5	5-7/16	5-23/32	4-9/32	1-7/32	3	8	3.96
869-422SR	4x3	4-5/8	5-7/16	5-11/16	4-1/4	31/32	3	8	3.19
869-523SR ¹	6x1/2	5-13/32	3	7-3/4	1-11/16	1-3/8	1-1/8	10	2.51
869-524SR ¹	6x3/4	5-7/16	3	7-3/4	1-11/16	1-3/8	1-1/8	10	2.48
869-525SR	6x1	5-1/8	3	7-15/16	1-11/16	15/16	1-1/8	10	2.39
869-526SR ¹	6x1-1/4	5-15/16	4-1/8	7-3/4	3	1-11/16	2-1/4	10	3.79
869-527SR ¹	6x1-1/2	5-15/16	4-1/8	7-3/4	3	1-3/4	2-1/4	10	3.70
869-528SR	6x2	5-1/2	4-1/8	7-3/4	3	1-7/32	2-1/4	10	3.43
869-529SR ¹	6x2-1/2	6-7/16	6	7-15/16	4-1/4	1-9/16	3	10	5.85
869-530SR	6x3	5-15/16	6	7-15/16	4-1/4	1-1/4	3	10	5.04
869-532SR	6x4	6	6	7-15/16	5-3/16	1-3/8	4	10	6.26
869-573SR ¹	8x1/2	8-3/32	8-1/2	10-1/8	5-1/4	3	4	10	11.52

¹ Outlet sized with bushing





Schedule 80 PVC Technical Information
Schedule 80 Saddles

CLAMP ON SADDLE x SR FIPT (continued)
DOUBLE OUTLET

Dimensions Also Applicable to
 869S-XXXSR, 869V-XXXSR & 869SV-XXXSR

2" - 4" 235 psi @ 73°F
 6" 200 psi @ 73°F
 8" - 12" 150 psi @ 73°F

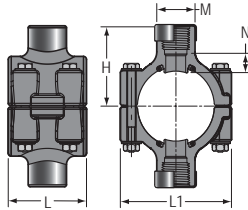

Part Number	Size	H	L	L1	M	N	Hole Size	Bolt Torque ft./lbs.	Approx. Wt. (Lbs.)
869-574SR ¹	8x3/4	8-3/32	8-1/2	10-1/8	5-1/4	3	4	10	---
869-575SR ¹	8x1	8-3/32	8-1/2	10-1/8	5-1/4	2-13/16	4	10	---
869-576SR ¹	8x1-1/4	8-3/32	8-1/2	10-1/8	5-1/4	2-3/4	4	10	---
869-577SR ¹	8x1-1/2	8-3/32	8-1/2	10-1/8	5-1/4	2-3/4	4	10	---
869-578SR ¹	8x2	7-11/16	8-1/2	10-1/8	5-1/4	2-3/8	4	10	---
869-579SR ¹	8x2-1/2	8-1/8	8-1/2	10-1/8	5-1/4	2-1/2	4	10	---
869-580SR ¹	8x3	7-11/16	8-1/2	10-1/8	5-1/4	1-15/16	4	10	---
869-582SR	8x4	7-5/16	8-1/2	10-1/8	5-1/4	1-1/2	4	10	8.59
869-585SR	8x6	8-3/32	8-1/2	10-1/8	7-5/8	2-3/32	6	10	10.32
869-624SR	10x4	8-15/32	8-1/2	12-5/16	5-1/4	2-3/16	4	10	---
869-626SR	10x6	9-9/32	8-1/2	12-5/16	7-5/8	3-3/16	6	10	---
869-664SR	12x4	9-9/16	8-1/2	14-5/16	5-1/4	1-5/8	4	10	---
869-666SR	12x6	10-3/8	8-1/2	14-5/16	7-5/8	2-1/4	6	10	---

¹ Outlet sized with bushing

- 1) Clamp On Saddle Standard Hardware: Zinc Bolts w/EPDM O-ring Seal
 e.g. Part Number 869-247SR = 2x1/2 PVC Clamp On Saddle, SR Threaded, EPDM O-ring, Zinc Bolts.
- 2) Clamp On Saddles w/Stainless Steel (SS) Bolts, Add The Letter "S" Before The Dash.
 e.g. Part Number 869S-247SR = 2x1/2 PVC Clamp On Saddle, SR Threaded, EPDM O-ring, Stainless Steel Bolts.
- 3) Clamp On Saddles w/FKM O-ring Seal, Add The Letter "V" Before The Dash.
 e.g. Part Number 869V-247SR = 2x1/2 PVC Clamp-On Saddle, SR Threaded, FKM O-ring, Zinc Bolts.
- 4) Clamp-On Saddles w/Stainless Steel Bolts & FKM O-ring Seal, Add The Letter "SV" Before The Dash.
 e.g. Part Number 869SV-247SR = 2x1/2 PVC Clamp On Saddle, SR Threaded FKM O-ring, Stainless Steel Bolts.

Schedule 80 PVC Technical Information
Schedule 80 Tank Adapters



NEW STYLE - TANK ADAPTER

Socket x Socket
 Dimensions Also Applicable
 to 8170E-XXX & 8170V-XXX

150 psi @ 73°F

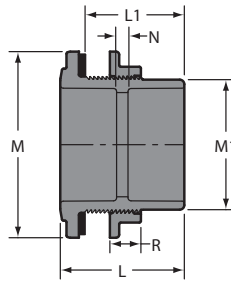

Part Number	Size	L	L1	M	M1	N	R	Approx. Wt. (Lbs.)
8170-002	1/4	2-1/2	1-13/16	1-1/2	1-1/16	1-3/16	1/2	.10
8170-003	3/8	2-1/2	1-27/32	1-5/8	31/32	7/8	1/2	.11
8170-005	1/2	2-15/16	2-3/16	2-1/16	1-3/16	1-1/8	5/8	.22
8170-007	3/4	2-15/16	2-3/16	2-1/4	1-5/8	15/16	5/8	.26
8170-010	1	3-5/16	2-9/16	2-5/8	2	1-1/16	5/8	.37
8170-012	1-1/4	3-7/16	2-5/8	3-1/8	2-5/16	15/16	5/8	.42
8170-015	1-1/2	3-5/8	2-13/16	3-5/8	2-11/16	13/16	5/8	.98
8170-020	2	4-1/8	3-1/4	4-7/8	3-1/4	1-1/16	3/4	1.28
8170-025	2-1/2	4-27/32	3-7/8	5-1/4	3-9/16	29/32	1	1.79
8170-030	3	5-1/2	4-1/2	6	4-9/16	1-11/16	1	2.62
8170-040	4	5	4	7-1/2	5-1/2	7/16	1-1/4	3.13
8170-080	8	8-5/8	7	12-15/16	10-1/4	1/2	1-1/2	16.02

Tank Adapter Referenced Dimension Tolerance = ± 1/16"

NEW STYLE - TANK ADAPTER

Socket x Fipt
 Dimensions Also Applicable to
 8171E-XXX & 8171V-XXX

150 psi @ 73°F

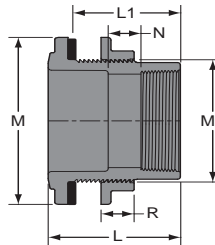

Part Number	Size	L	L1	M	M1	N	R	Approx. Wt. (Lbs.)
8171-002	1/4	2-1/2	1-13/16	1-1/2	1-1/16	1-1/4	1/2	.10
8171-003	3/8	2-1/2	1-13/16	1-5/8	1-3/16	1-3/16	1/2	.11
8171-005	1/2	2-15/16	2-3/16	2-1/16	1-3/16	1-1/4	5/8	.22
8171-007	3/4	2-15/16	2-15/32	2-1/4	1-5/8	1-3/16	5/8	.25
8171-010	1	3-5/16	2-13/16	2-5/8	1-31/32	1-1/4	5/8	.36
8171-012	1-1/4	3-13/32	2-27/32	3-3/32	2-5/16	1-17/32	5/8	.50
8171-015	1-1/2	3-5/8	2-13/16	3-5/8	2-11/16	1-1/4	5/8	.67
8171-020	2	4-1/8	3-1/4	4-7/8	3-1/4	1-5/8	3/4	1.32
8171-025	2-1/2	4-7/8	7/8	5-1/4	3-13/16	1-13/16	1	1.78
8171-030	3	5-1/2	4-1/2	6	4-9/16	2-3/16	1	2.61
8171-040	4	5	4	7-1/2	5-1/2	1-1/4	1-1/4	3.24
8171-060	6	4-31/32	4-1/16	10-1/16	7-11/16	1/16	1-1/4	5.65



Schedule 80 PVC Technical Information
Schedule 80 Tank Adapters

NEW STYLE - TANK ADAPTER

Socket x SR Fipt
 Dimensions Also Applicable to
 8171E-XXXSR & 8171V-XXXSR

150 psi @ 73°F

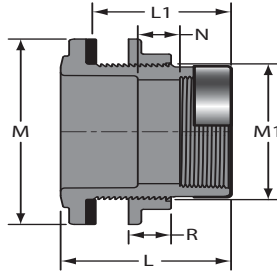

Part Number	Size	L	L1	M	M1	N	R	Approx. Wt. (Lbs.)
8171-002SR	1/4	2-1/2	1-13/16	1-1/2	1-1/16	1-1/4	1/2	.11
8171-003SR	3/8	2-1/2	1-13/16	1-5/8	1-3/16	1-3/16	1/2	.12
8171-005SR	1/2	2-15/16	2-1/4	2-1/16	1-7/32	1-9/32	5/8	.22
8171-007SR	3/4	2-15/16	2-3/16	2-1/4	1-5/8	1-1/4	5/8	.26
8171-010SR	1	3-5/16	2-13/16	2-5/8	1-31/32	1-1/4	5/8	.36
8171-012SR	1-1/4	3-13/32	2-5/8	3-3/32	2-5/16	1-17/32	5/8	.50
8171-015SR	1-1/2	3-5/8	2-13/16	3-5/8	2-11/16	1-1/4	5/8	.70
8171-020SR	2	4-1/8	3-1/4	4-7/8	3-1/4	1-5/8	3/4	1.36
8171-025SR	2-1/2	4-7/8	3-7/8	5-1/4	3-13/16	1-11/16	1	1.90
8171-030SR	3	5-1/2	4-1/2	6	4-9/16	2-3/16	1	2.78
8171-040SR	4	5	4	7-1/2	5-1/2	1-1/4	1-1/4	3.60
8171-060SR	6	4-31/32	4-1/16	10-1/16	7-11/16	1/16	1-1/4	5.74

NEW STYLE - TANK ADAPTER

Fipt x Fipt
 Dimensions Also Applicable
 to 8172E-XXX & 8172V-XXX

150 psi @ 73°F

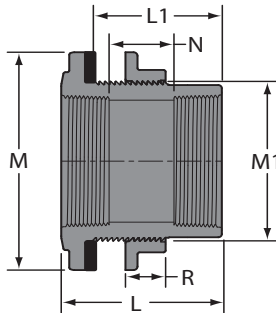

Part Number	Size	L	L1	M	M1	N	R	Approx. Wt. (Lbs.)
8172-002	1/4	2-1/2	1-13/16	1-1/2	1-1/16	1-5/16	1/2	.10
8172-003	3/8	2-1/2	1-13/16	1-5/8	1-3/16	1-3/8	1/2	.13
8172-005	1/2	2-15/16	2-3/16	2-1/16	1-3/16	1-13/32	5/8	.23
8172-007	3/4	2-15/16	2-15/32	2-1/4	1-5/8	1-1/2	5/8	.25
8172-010	1	3-5/16	2-13/16	2-5/8	1-31/32	1-1/4	5/8	.36
8172-012	1-1/4	3-13/32	2-27/32	3-3/32	2-5/16	1-17/32	5/8	.50
8172-015	1-1/2	3-19/32	3-1/16	3-19/32	2-21/32	1-11/16	5/8	.68
8172-020	2	4-1/8	3-1/4	4-7/8	3-1/4	2-3/16	3/4	1.34
8172-025	2-1/2	4-7/8	3-7/8	5-1/4	3-13/16	2-1/4	1	1.91
8172-030	3	5-1/2	4-1/2	6	4-9/16	2-11/16	1	2.80
8172-040	4	5	4	7-1/2	5-1/2	2	1-1/4	3.53
8172-060	6	5	4-3/16	9-7/8	7-31/32	1-5/32	1-1/4	5.90

Schedule 80 PVC Technical Information
Schedule 80 Tank Adapters



NEW STYLE - TANK ADAPTER

Fipt x SR Fipt

Dimensions Also Applicable to 8172E-XXXSR & 8172V-XXXSR

150 psi @ 73°F

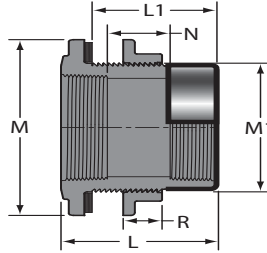

Part Number	Size	L	L1	M	M1	N	R	Approx. Wt. (Lbs.)
8172-002SR	1/4	2-1/2	1-7/8	1-9/16	1-1/16	1-5/16	1/2	.12
8172-003SR	3/8	2-1/2	1-13/16	1-5/8	1-3/16	1-3/8	1/2	.14
8172-005SR	1/2	2-15/16	2-3/16	2-1/16	1-7/32	1-13/32	5/8	.24
8172-007SR	3/4	2-15/16	2-15/32	2-1/4	1-5/8	1-3/16	5/8	.26
8172-010SR	1	3-15/16	2-19/32	2-5/8	1-31/32	1-1/4	5/8	.38
8172-012SR	1-1/4	3-13/32	2-27/32	3-3/32	2-5/16	1-17/32	5/8	.50
8172-015SR	1-1/2	3-5/8	2-13/16	3-5/8	2-11/16	1-3/4	5/8	.73
8172-020SR	2	4-1/8	3-1/4	4-27/32	3-1/32	2-1/8	3/4	1.34
8172-025SR	2-1/2	4-7/8	3-7/8	5-1/4	3-13/16	2-1/4	1	1.97
8172-030SR	3	5-15/32	4-17/32	5-31/32	4-17/32	2-21/32	1	2.87
8172-040SR	4	5	4	7-1/2	5-1/2	2	1-1/4	3.61



TANK ADAPTER GASKET SECTION	SIZE	O.D.*	I.D.*	T
	1/4	1.49	0.99	1/4
	3/8	1.62	1.12	1/4
	1/2	1.98	1.41	1/4
	3/4	2.20	1.57	1/4
	1	2.60	1.90	1/4
	1-1/4	3.04	2.23	1/4
	1-1/2	3.54	2.57	1/4
	2	4.76	3.15	1/4
	2-1/2	5.13	3.70	1/4
	3	5.86	4.39	1/4
	4	7.34	5.31	1/4
	6	9.85	7.95	3/16
	8	12.70	9.94	3/8

New Style Tank Adapter Gasket & Hole Size Requirements			
Tank Adapter Size	Recommended Minimum Hole Size	Minimum Inside Curvature Radius (inches)	Maximum Tank Wall Thickness (inches)
1/4	1-1/16	2.50	.50
3/8	1-3/16	3.00	.50
1/2	1-1/2	4.00	.75
3/4	1-3/4	5.00	.75
1	2	7.00	.86
1-1/4	2-3/8	9.50	.86
1-1/2	2-3/4	12.00	.86
2	3-3/8	18.50	1.19
2-1/2	3-7/8	23.50	1.50
3	4-5/8	32.50	2.00
4	5-1/2	43.50	1.25
6	8	79.50	2.06
8	10-3/8	98.00	4.25

* Both outside and inside dimensions are +/- .01 to .03 shore hardness 50-60



Schedule 80 PVC Technical Information
Schedule 80 Tank Adapters

OLD STYLE - TANK ADAPTER

Socket x Fipt

Dimensions Also Applicable to 871E-XXX

150 psi @ 73°F

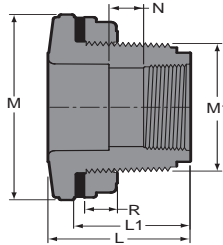

Part Number	Size	L	L1	M	M1	N	R	Approx. Wt. (Lbs.)
871-005	1/2	2-27/32	2-11/32	2-9/32	1-9/32	1-3/8	5/8	.24
871-007	3/4	2-23/32	2-7/32	2-1/2	1-5/8	29/32	5/8	.30
871-010	1	2-25/32	2-1/8	2-13/16	1-7/8	25/32	21/32	.34
871-012	1-1/4	3-1/8	2-7/16	3-29/32	2-11/32	27/32	5/8	.64
871-015	1-1/2	3-5/32	2-21/32	3-29/32	2-11/32	3/4	5/8	.55
871-020	2	3-3/16	2-17/32	4-31/32	3-15/32	13/16	3/4	1.33
871-030	3	4-19/32	3-13/16	6-7/16	4-15/32	31/32	1-3/16	2.47
871-040	4	4-7/16	3-23/32	7-7/16	5-1/2	1/2	1-1/4	3.17

OLD STYLE - TANK ADAPTER

Fipt x Fipt

Dimensions Also Applicable to 872E-XXX

150 psi @ 73°F

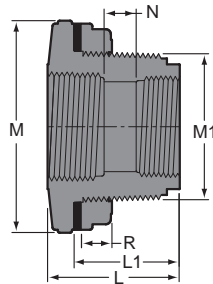

Part Number	Size	L	L1	M	M1	N	R	Approx. Wt. (Lbs.)
872-005	1/2	2-27/32	2-11/32	2-9/32	1-9/32	1-13/32	5/8	.24
872-007	3/4	2-23/32	2-1/4	2-1/2	1-5/8	1-5/32	5/8	.31
872-010	1	2-25/32	2-5/16	2-13/16	1-7/8	25/32	5/8	.36
872-012	1-1/4	3-1/8	2-5/8	3-27/32	2-11/32	1-1/8	5/8	.67
872-015	1-1/2	3-1/8	2-5/8	3-29/32	2-11/32	1-1/16	5/8	.58
872-020	2	3-5/32	2-3/8	5-1/16	3-7/16	1-5/32	3/4	1.35
872-030	3	4-19/32	3-13/16	6-7/16	4-15/32	1-11/32	1-3/16	2.56
872-040	4	4-7/16	3-1/2	7-1/2	5-1/2	15/16	1-1/4	3.34

Schedule 80 PVC Technical Information
Schedule 80 Tank Adapters



TANK ADAPTER GASKET SECTION					Old Style Tank Adapter Gasket & Hole Size Requirements			
	SIZE	O.D.*	I.D.*	T	Tank Adapter Size	Recommended Minimum Hole Size	Minimum Inside Curvature Radius (inches)	Maximum Tank Wall Thickness (inches)
	1/2	2.25	1.33	3/16	1/2	1-3/8	3.88	1.06
	3/4	2.49	1.69	3/16	3/4	1-3/4	5.00	1.06
	1	2.79	1.94	3/16	1	2	6.12	1.06
	1-1/4	3.81	2.39	3/16	1-1/4	2-7/16	10.75	1.34
	1-1/2	3.81	2.39	3/16	1-1/2	2-7/16	10.75	1.34
	2	4.89	3.51	3/16	2	3-9/16	18.50	1.16
	3	6.30	4.49	3/16	3	4-9/16	31.00	1.75
	4	7.33	5.50	3/16	4	5-9/16	42.75	1.81

* Both outside and inside dimensions are +/- .03 shore hardness 65-70



SELF ALIGNING TANK ADAPTER

Fipt

Dimensions Also Applicable to 8172ESA-XXX & 8172VSA-XXX

75 psi @ 73°F

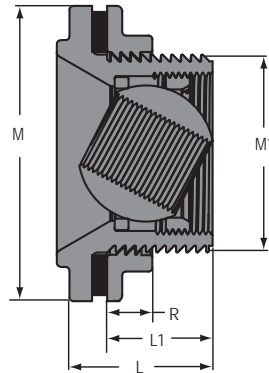

Part Number	Size	L	L1	M	M1	R	Approx. Wt. (Lbs.)
8172SA-010	1	2-9/16	1-3/4	4-7/8	3-1/4	3/4	1.11
8172SA-020	2	2-11/16	1-3/4	6	4-9/16	1	1.99
8172SA-030	3	3-1/4	2-1/4	7-1/2	5-1/2	1-1/4	2.61



THERMOPLASTIC FLANGES

MOLDED & FABRICATED



TECHNICAL INFORMATION

WEIGHTS & DIMENSIONS

Contact Spears® for any information not found.

Schedule 80 PVC Technical Information PVC Pipe Flange Dimensions & Information



The information contained in this publication is based on current information and Product design at the time of publication and is subject to change without notification. Our ongoing commitment to product improvement may result in some variation. No representations, guarantees or warranties of any kind are made as to its accuracy, suitability for particular applications or results to be obtained therefrom. For verification of technical data or additional information not contained herein, please contact Spears® Technical Services Department [West Coast: (818) 364-1611 — East Coast: (678) 985-1263].

GENERAL INFORMATION

Recommendations For Installers And Users

Plastic piping systems should be **ENGINEERED, INSTALLED, and OPERATED** in accordance with **ESTABLISHED DESIGN AND ENGINEERING STANDARDS AND PROCEDURES** for plastic piping systems. Suitability for the intended service application should be determined by the installer and /or user prior to installation of a plastic piping system. **PRIOR TO ASSEMBLY, all piping system components should be inspected for damage or irregularities. Mating components should be checked to assure that tolerances and engagements are compatible. Do not use any components that appear irregular or do not fit properly. Contact the appropriate manufacturer of the component product in question to determine usability.**



Solvent Weld Connections — Use quality solvent cements and primers formulated for the intended service application, pipe size and type of joint. While the pipe and fitting materials may be compatible with the intended medium, the solvent cement may not be. Consult the manufacturer for suitability of use. Read and follow the cement and primer manufacturers' applications and cure time instructions thoroughly. Be sure to use the correct size applicator.

Threaded Connections — Use a quality grade thread sealant. **WARNING: SOME PIPE JOINT COMPOUNDS OR PTFE PASTES MAY CONTAIN SUBSTANCES THAT COULD CAUSE STRESS CRACKING TO PLASTIC.** Spears® Manufacturing Company recommends the use of Spears® **Blue 75™** thread sealant which has been tested for compatibility with Spears® products. Please follow the sealant manufacturer's application/installation instructions. Choice of an appropriate thread sealant other than those listed above is at the discretion of the installer. 1 to 2 turns beyond **FINGER TIGHT** is generally all that is required to make a sound plastic thread connection. Unnecessary **OVERTIGHTENING** will cause **DAMAGE TO BOTH PIPE AND FITTING**.

"Lead Free" low lead certification – unless otherwise specified, all Spears® Thermoplastic Flanges specified here-in are certified by NSF International to ANSI/NSF® Standard 61, Annex G and is in compliance with California's Health & Safety Code Section 116825 (commonly known as AB1953) and Vermont Act 193. Weighted average lead content <=0.25%.





Schedule 80 PVC Technical Information PVC Pipe Flange Dimensions & Information

Bolt Kit Selection Guide

**Bolt Hardware Kits Available
For Connection of 2-Spears® Flanges
Includes Bolts, Nuts & Flat Washers for Specified Flange Size**

Order Gaskets & Bolt Kits Separately

- Pre-coated, Anti-seize Lubricated Bolts
- Available in Zinc Coated Steel, Type 316 Stainless Steel or Type 304 Stainless Steel

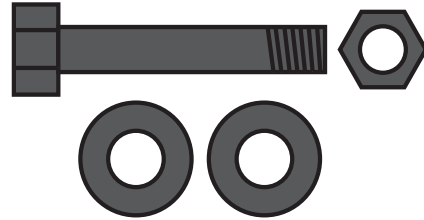

Flange Size	Bolts* Per Kit	Diameter (in.-TPI)	Length (in.)	Kit Part Number		
				Zinc	316 SS	304 SS
1/2 & 3/4	4	1/2 - 13	2	HK-005	HK1-005	HK2-005
1 & 1-1/4	4	1/2 - 13	2-1/4	HK-010	HK1-010	HK2-010
1-1/2	4	1/2 - 13	2-1/2	HK-015	HK1-015	HK2-015
2	4	5/8 - 11	3	HK-020	HK1-020	HK2-020
2-1/2	4	5/8 - 11	3-1/4	HK-025	HK1-025	HK2-025
3	4	5/8 - 11	3-1/2	HK-030	HK1-030	HK2-030
4	8	5/8 - 11	3-1/2	HK-040	HK1-040	HK2-040
5 & 6	8	3/4 - 10	4	HK-060	HK1-060	HK2-060
8	8	3/4 - 10	4-1/2	HK-080	HK1-080	HK2-080
10 & 12	12	7/8 - 9	5	HK-120	HK1-120	HK2-120

* Each Bolt Includes Nut & Two (2) Flat Washers

Bolt Torque

Recommended Bolt Torque is shown in **Table 1**. Threads should be clean and well lubricated. Actual field conditions may require variations in these recommendations. **CAUTION: UNNECESSARY OVER TORQUING WILL DAMAGE THE FLANGE.**

Table 1

Flange Size (in.)	Recommended Torque (ft. lbs.)
1/2 - 1-1/2	12
2 - 4	25
5	30
6 - 8	40
10	64
12	95
14 - 24	110

Torque Sequence

Bolt Torque sequence is shown Below in **Table 2**.

Table 2

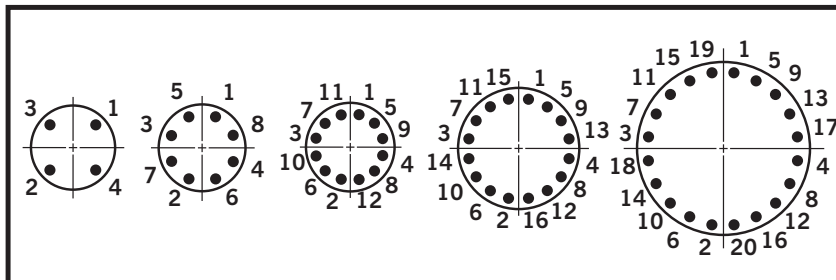

Schedule 80 PVC Technical Information

PVC Pipe Flange Dimensions & Information



Gaskets

Full faced, 1/8" thick elastomer gaskets with a Shore "A" Durometer of approximately 70 is recommended.

Gasket Selection Guide

Following Gasket Numbers Available from Spears®

Order Gaskets & Bolt Kits Separately

- 1/8" Full-Face design with ANSI Class 150 Bolt Patterns
- Pressure rated to 150 psi @ 73°F
- Available in Buna-N, EPDM, or FKM

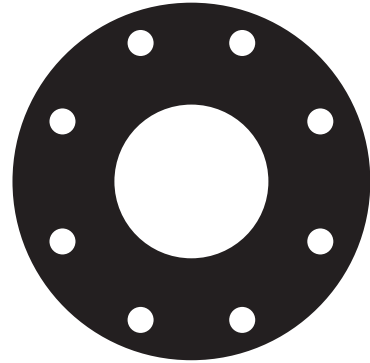

Flange Size	Bolts Per Kit	Gasket Part Number		
		Buna-N	EPDM	FKM
1/2	4	GK1-005	GK2-005	GK3-005
3/4	4	GK1-007	GK2-007	GK3-007
1	4	GK1-010	GK2-010	GK3-010
1-1/4	4	GK1-012	GK2-012	GK3-012
1-1/2	4	GK1-015	GK2-015	GK3-015
2	4	GK1-020	GK2-020	GK3-020
2-1/2	4	GK1-025	GK2-025	GK3-025
3	4	GK1-030	GK2-030	GK3-030
4	8	GK1-040	GK2-040	GK3-040
5	8	GK1-050	GK2-050	GK3-050
6	8	GK1-060	GK2-060	GK3-060
8	8	GK1-080	GK2-080	GK3-080
10	12	GK1-100	GK2-100	GK3-100
12	12	GK1-120	GK2-120	GK3-120



Flange Make-up

Once a flange is joined to pipe, the method for joining two flanges is as follows:

1. Piping runs joined to the flanges must be installed in a straight line position to the flange to avoid stress at the flange due to misalignment. Piping must also be secured and supported to prevent lateral movement which can create stress and damage the flange.
2. With gasket in place, align the bolt holes of the mating flanges by rotating the ring into position.
3. Insert all bolts, washers (two standard flat washers per bolt), and nuts.
4. Make sure the faces of the mating surfaces are flush against gasket prior to bolting down the flanges.
5. Tighten the nuts by hand until they are snug. Establish uniform pressure over the flange face by tightening the bolts in 5 ft.-lbs. increments according to the sequence shown in **Table 2** following a 180° opposing sequence.
6. Care must be taken to avoid "bending" the flange when joining a Spears® flange to a "raised face" flange, or a wafer-style valve. Do not use bolts to bring together improperly mated flanges.

Configuration Terminology

Multi-Bolt Pattern Ring — Bolt hole drilling accepts ANSI and Metric Flanges

Socket — Slip socket connection for solvent cement welding

Spigot — Pipe O.D. connection for solvent welding

Fipt — Female Iron Pipe Thread

SR Fipt — Spears® patented Special Reinforced (SR) plastic thread

IPS — Iron Pipe Size

PIP — Plastic Irrigation Pipe



Schedule 80 PVC Technical Information

PVC Pipe Flange Dimensions & Information

Technical Information

Application

Molded CLASS 150 Flange fittings are coupling devices designed for joining IPS (Iron Pipe Size) plastic piping systems, where frequent disassembly may be required, and can be used as a transitional fitting for joining plastic to metal piping systems. Suitability of application is at the discretion of the user.

Pressure Rating

150 psi, water at 73°F.

Flange Types

One Piece — Available in socket configuration, sizes 1/2" through 8"; threaded and SR threaded (Special Reinforced) configuration sizes 1/2" through 4".

Van Stone Style — Two-piece design with rotating flange ring, available in socket configurations, sizes 1/2" through 16"; threaded configurations, sizes 1/2" through 4" and spigot configurations, sizes 1/2" through 12".

Blind — Closed ring design for capping off a mating flange, flanged fitting or flanged valve, available in sizes 1/2" through 12".

Materials

All injection molded flanges are produced from PVC materials approved for potable water use by the National Sanitation Foundation (NSF®).

Glass-filled PVC materials may be used in certain Van Stone Style flange rings and large diameter Blind flanges where additional reinforcement is deemed necessary.

Conformance Standards

Socket & Spigot — ASTM D 2467 (PVC).

Threads — ASTM F 1498.

Bolt Hole Pattern — ANSI B16.5; ASTM D 4024.

Material — ASTM D 1784 (PVC Cell Classification 12454-B).

Weights & Dimensions

Specified minimum bolt lengths are based on the use of two Spears® Flanges, two standard flat washers, standard nut and 1/8" thick elastomer full face gasket. Mating with other brands or accessories may require variation. Bolts and gaskets are not supplied with flanges.

Dimension references:

- L** = Overall length of hub, $\pm 1/16$ inch.
- M** = Outside diameter of socket hub, $\pm 1/16$ inch.
- N** = (Laying Length) socket/spigot bottom to seal-ring face of flange, $\pm 1/16$ inch.
- R** = Height (thickness) of flange ring, $\pm 1/16$ inch.
- Max O.D.** = Outside diameter of ring, $\pm 1/16$ inch.
- Bolt Circle Diameter** = ANSI B 16.5 Standard; ASTM D 4024, $\pm 1/16$ inch.

Schedule 80 PVC Technical Information
PVC Pipe Flange Dimensions & Information



Flange One Piece

Socket

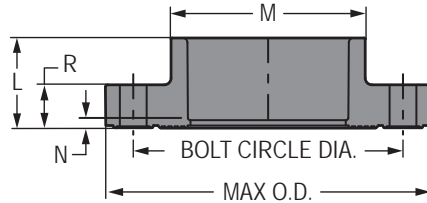

Part Number	Size	L	M	N	R	Bolt Circle Dia.	No. of Bolt Holes	Bolt Size	Min. Bolt Length	Max O.D.	Approx. Wt. (Lbs.)
851-005	1/2	1-1/16	1-9/32	1/8	9/16	2-3/8	4	1/2	2	3-1/2	.22
851-007	3/4	1-3/16	1-1/2	1/8	5/8	2-3/4	4	1/2	2	3-7/8	.31
851-010	1	1-5/16	1-13/16	3/16	3/4	3-1/8	4	1/2	2-1/4	4-1/4	.44
851-012	1-1/4	1-3/8	2-3/16	3/32	21/32	3-1/2	4	1/2	2-1/4	4-5/8	.42
851-015	1-1/2	1-19/32	2-1/2	3/16	23/32	3-7/8	4	1/2	2-1/2	5-1/16	.58
851-020	2	1-27/32	3	5/16	27/32	4-3/4	4	5/8	3	6	.82
851-025	2-1/2	2-1/4	3-1/2	1/2	1	5-1/2	4	5/8	3-1/4	7	1.63
851-030	3	2-5/16	4-9/32	3/8	1-1/16	6	4	5/8	3-1/4	7-1/2	1.74
851-040	4	2-7/16	5-7/32	3/16	1-5/32	7-1/2	8	5/8	3-1/2	9-1/16	2.67
851-050	5	3-1/4	6-3/8	1/4	1	8-1/2	8	3/4	3-3/4	10-1/8	3.00
851-060	6	3-1/4	7-9/16	1/4	1-3/8	9-1/2	8	3/4	4	11	4.06
851-080	8	4-17/32	9-3/4	1/2	1-7/16	11-11/16	8	3/4	4-1/2	13-5/8	7.67
851-100F	10	9-7/8	11-15/16	4-5/8	1-3/8	14-1/4	12	7/8	4	16	16.96
851-120F	12	10-11/16	14-1/8	4-7/16	1-3/8	17	12	7/8	5	19	26.37

Flange One Piece

Fipt

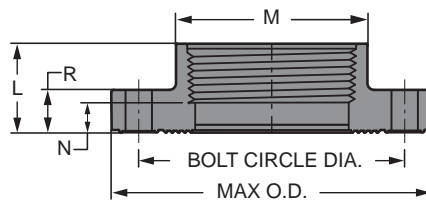

Part Number	Size	L	M	N	R	Bolt Circle Dia.	No. of Bolt Holes	Bolt Size	Min. Bolt Length	Max O.D.	Approx. Wt. (Lbs.)
852-005	1/2	1-1/16	1-5/16	9/32	9/16	2-3/8	4	1/2	2	3-1/2	.21
852-007	3/4	1-3/16	1-17/32	15/32	5/8	2-3/4	4	1/2	2	3-7/8	.30
852-010	1	1-5/16	1-13/16	7/16	3/4	3-1/8	4	1/2	2-1/4	4-1/4	.41
852-012	1-1/4	1-3/8	2-7/32	17/32	23/32	3-1/2	4	1/2	2-1/4	4-5/8	.44
852-015	1-1/2	1-11/16	2-1/2	19/32	23/32	3-27/32	4	1/2	2-1/2	5-1/16	.61



Schedule 80 PVC Technical Information
PVC Pipe Flange Dimensions & Information

Flange One Piece (continued)

Fipt

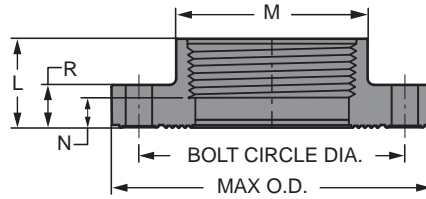

Part Number	Size	L	M	N	R	Bolt Circle Dia.	No. of Bolt Holes	Bolt Size	Min. Bolt Length	Max O.D.	Approx. Wt. (Lbs.)
852-020	2	1-27/32	3	7/8	7/8	4-3/4	4	5/8	3	6	.96
852-025	2-1/2	2-1/4	3-1/2	15/16	1	5-1/2	4	5/8	3-1/4	7	1.65
852-030	3	2-5/16	4-9/32	29/32	1-1/16	6	4	5/8	3-1/4	7-1/2	1.83
852-040	4	2-1/16	5-7/16	5/16	1-1/4	7-1/2	8	5/8	3-1/2	9	2.79
852-050F	5	6-5/8	6-1/8	5-1/4	1-5/16	8-1/2	8	3/4	3-3/4	10-1/8	5.25
852-060F	6	6-15/16	7-1/4	5-1/2	1-5/16	9-1/2	8	3/4	4	11	7.16
852-080F	8	8-9/16	9-7/16	6-15/16	1-7/16	11-3/4	8	3/4	4-1/2	13-1/2	13.41
852-100F	10	7-3/8	11-3/4	5-1/2	1-3/8	14-1/4	12	7/8	5	16	20.65
852-120F	12	7	13-15/16	5	1-3/8	17	12	7/8	4	19	21.79

Special Reinforced Flange One Piece

SR Fipt

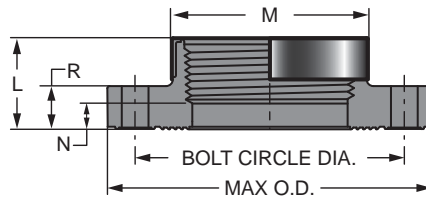

Part Number	Size	L	M	N	R	Bolt Circle Dia.	No. of Bolt Holes	Bolt Size	Min. Bolt Length	Max O.D.	Approx. Wt. (Lbs.)
852-005SR	1/2	1-3/32	1-7/32	11/32	9/16	2-3/8	4	1/2	2	3-1/2	.20
852-007SR	3/4	1-3/16	1-3/8	7/16	5/8	2-3/4	4	1/2	2	3-7/8	.27
852-010SR	1	1-7/16	1-23/32	17/32	21/32	3-1/8	4	1/2	2-1/4	4-1/4	.37
852-012SR	1-1/4	1-9/16	2-1/16	19/32	21/32	3-1/2	4	1/2	2-1/4	4-5/8	.49
852-015SR	1-1/2	1-3/4	2-7/16	3/4	3/4	3-7/8	4	1/2	2-1/2	5	.63
852-020SR	2	1-13/16	3-1/32	13/16	13/16	4-3/4	4	5/8	3	5-31/32	.99
852-025SR	2-1/2	2-1/8	3-19/32	3/8	1	5-1/2	4	5/8	3-1/4	7	1.58
852-030SR	3	2-5/16	4-9/32	27/32	1-1/16	6	4	5/8	3-1/4	7-1/2	1.79
852-040SR	4	2-1/2	5-1/4	1	1-5/32	7-1/2	8	5/8	3-1/2	9	2.74

Schedule 80 PVC Technical Information
PVC Pipe Flange Dimensions & Information



BLIND FLANGE

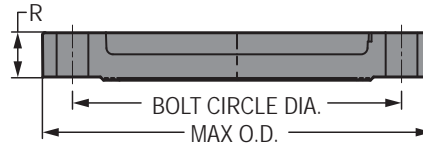

Part Number	Size	R	Bolt Circle Dia.	No. of Bolt Holes	Bolt Size	Min. Bolt Length	Max. O.D.	Approx. Wt. (Lbs.)
853-005	1/2	17/32	2-3/8	4	1/2	2	3-17/32	.19
853-007	3/4	5/8	2-3/4	4	1/2	2	3-7/8	.28
853-010	1	3/4	3-1/8	4	1/2	2-1/4	4-1/4	.41
853-012	1-1/4	23/32	3-1/2	4	1/2	2-1/4	4-5/8	.37
853-015	1-1/2	23/32	3-27/32	4	1/2	2-1/2	5-1/16	.50
853-020	2	27/32	4-3/4	4	5/8	3	5-31/32	.82
853-025	2-1/2	1	5-1/2	4	5/8	3-1/4	7	1.61
853-030	3	1-1/16	6	4	5/8	3-1/4	7-1/2	1.63
853-040	4	1-5/32	7-1/2	8	5/8	3-1/2	9-1/16	2.42
853-060	6	1-3/8	9-1/2	8	3/4	4	11	4.36
853-080	8	1-7/16	11-3/4	8	3/4	4-1/2	13-1/2	6.83
853-100	10	1-11/16	14-1/4	12	7/8	5	16	11.32
853-120	12	1-11/16	17	12	7/8	5	19	15.49



Flange Van Stone Style

(Two Piece)

Socket

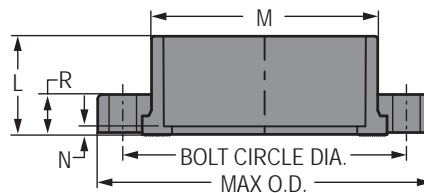

Part Number	Size	L	M	N	R	Bolt Circle Dia.	No. of Bolt Holes	Bolt Size	Min. Bolt Length	Max O.D.	Approx. Wt. (Lbs.)
854-005	1/2	1-1/32	1-7/32	5/32	17/32	2-3/8	4	1/2	2	3-1/2	.19
854-007	3/4	1-1/8	1-7/16	5/32	9/16	2-3/4	4	1/2	2	3-7/8	.26
854-010	1	1-9/32	1-3/4	5/32	5/8	3-1/8	4	1/2	2-1/4	4-1/4	.36
854-012	1-1/4	1-13/32	2-5/32	5/32	11/16	3-1/2	4	1/2	2-1/4	4-5/8	.46
854-015	1-1/2	1-17/32	2-7/16	3/16	3/4	3-7/8	4	1/2	2-1/2	5	.56
854-020	2	1-11/16	2-15/16	3/16	13/16	4-3/4	4	5/8	3	6	.85



Schedule 80 PVC Technical Information
PVC Pipe Flange Dimensions & Information

Flange Van Stone Style (continued)

(Two Piece)

Socket

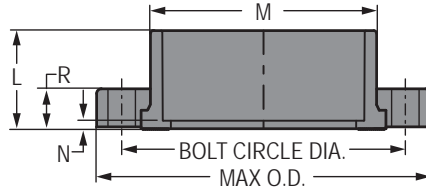

Part Number	Size	L	M	N	R	Bolt Circle Dia.	No. of Bolt Holes	Bolt Size	Min. Bolt Length	Max O.D.	Approx. Wt. (Lbs.)
854-025	2-1/2	2	3-1/2	3/16	31/32	5-1/2	4	5/8	3-1/4	7	1.40
854-030	3	2-1/8	4-1/4	1/4	1-1/16	6	4	5/8	3-1/4	7-1/2	1.66
854-040	4	2-1/2	5-1/4	1/4	1-1/8	7-1/2	8	5/8	3-1/2	9	2.68
854-050	5	3	6-1/4	3/8	1-1/8	8-1/2	8	3/4	3-3/4	10-1/8	3.35
854-060	6	3-3/8	7-9/16	7/16	1-9/32	9-1/2	8	3/4	4	11	4.54
854-080	8	4-3/8	9-5/16	9/32	1-3/8	11-3/4	8	3/4	4-1/2	13-1/2	6.69
854-100	10	5-11/16	11-3/4	21/32	1-5/8	14-1/4	12	7/8	5	16	11.45
854-120	12	7-1/4	13-3/4	5/8	1-1/2	17	12	7/8	5	19	16.78
854-140	14	7-1/2	15-1/2	1/2	2	18-3/4	12	1	5-1/2	21	26.84
854-160	16	8-3/4	17-3/4	3/4	2-3/8	21-1/4	16	1	6-1/2	23-1/2	37.64
854-180	18	9	20	1/4	2-3/8	22-3/4	16	1-1/8	6-1/2	25	45.33

Flange Van Stone Style

with Plastic Solid Ring

(Two Piece)

Socket

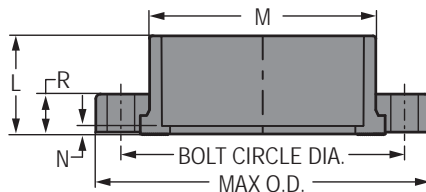

Part Number	Size	L	M	N	R	Bolt Circle Dia.	No. of Bolt Holes	Bolt Size	Min. Bolt Length	Max O.D.	Approx. Wt. (Lbs.)
S854-020	2	1-11/16	2-15/16	3/16	13/16	4-3/4	4	5/8	3	6	.85
S854-030	3	2-1/8	4-1/4	1/4	1-1/16	6	4	5/8	3-1/4	7-1/2	1.66
S854-040	4	2-1/2	5-1/4	1/4	1-1/8	7-1/2	8	5/8	1/2	9	3.02
S854-060	6	3-3/8	7-9/16	7/16	1-9/32	9-1/2	8	3/4	4	11	4.54

Schedule 80 PVC Technical Information
PVC Pipe Flange Dimensions & Information



Flange Van Stone Style (continued)

with Plastic Solid Ring
 (Two Piece)

Socket

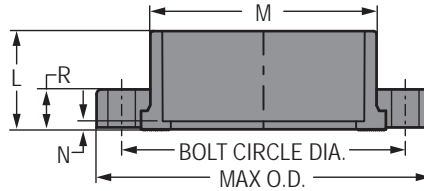

Part Number	Size	L	M	N	R	Bolt Circle Dia.	No. of Bolt Holes	Bolt Size	Min. Bolt Length	Max O.D.	Approx. Wt. (Lbs.)
S854-080	8	4-3/8	9-5/16	3/8	1-3/8	11-3/4	8	3/4	4-1/2	13-1/2	6.69
S854-100	10	5-11/16	11-3/4	11/16	1-5/8	14-1/4	12	7/8	5	16	11.69
S854-120	12	7-1/4	13-3/4	5/8	1-3/4	17	12	7/8	5	19	16.78



Flange Van Stone Style

with Multi-Bolt Pattern Ring
 (Two Piece)

Socket

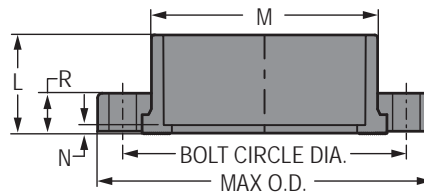

Part Number	Size	L	M	N	R	Bolt Circle Dia.		No. of Bolt Holes	Bolt Size	Max O.D.	Approx. Wt. (Lbs.)
						Min	Max				
M854-020	2	1-11/16	2-15/16	3/16	13/16	4-1/2	4-15/16	4	5/8	6	.85
M854-060	6	3-3/8	7-9/16	7/16	1-9/32	9-7/32	9-1/2	8	3/4	11	4.80
M854-080	8	4-3/8	9-5/16	3/8	1-3/8	11-1/2	11-3/4	8	3/4	13-1/2	6.69



Schedule 80 PVC Technical Information
PVC Pipe Flange Dimensions & Information

Flange Van Stone Style

(Two Piece)

Fipt

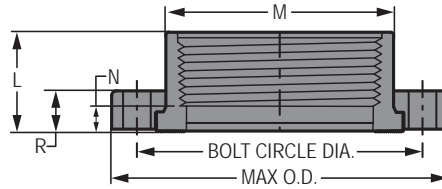

Part Number	Size	L	M	N	R	Bolt Circle Dia.	No. of Bolt Holes	Bolt Size	Min. Bolt Length	Max. O.D.	Approx. Wt. (Lbs.)
855-005	1/2	1-1/32	1-7/32	9/32	17/32	2-3/8	4	1/2	2	3-1/2	.19
855-007	3/4	1-5/32	1-3/8	13/32	9/16	2-3/4	4	1/2	2	3-7/8	.27
855-010	1	1-1/4	1-3/4	5/16	5/8	3-1/8	4	1/2	2-1/4	4-1/4	.36
855-012	1-1/4	1-3/8	2-1/8	13/32	11/16	3-1/2	4	1/2	2-1/4	4-5/8	.46
855-015	1-1/2	1-15/32	2-7/16	13/32	3/4	3-7/8	4	1/2	2-1/2	5	.55
855-020	2	1-9/16	2-31/32	1/2	13/16	4-3/4	4	5/8	3	6	.87
855-025	2-1/2	2	3-9/16	7/16	1	5-1/2	4	5/8	3-1/4	7	1.22
855-030	3	2-1/8	4-1/4	1/2	1-1/16	6	4	5/8	3-1/4	7-1/2	1.73
855-040	4	2-1/16	5-1/4	3/8	1-1/4	7-1/2	8	5/8	3-1/2	9	2.61
855-060F	6	6-3/8	7-3/16	4-15/16	1-1/4	9-1/2	8	3/4	4	11	7.62
855-080F	8	8-1/8	9-5/16	6-7/16	1-1/2	11-3/4	8	3/4	4-1/2	13-1/2	12.84
855-100F	10	10-3/8	11-9/16	8-9/16	1-11/16	14-1/4	12	7/8	5	16	20.65
855-120F	12	11-13/16	13-3/4	9-3/4	1-5/8	17	12	7/8	5	19	33.52

Flange Van Stone Style

(Two Piece)

Spigot

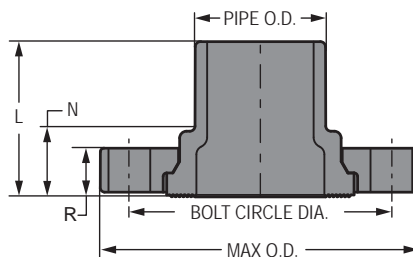

Part Number	Size	L	N	R	Bolt Circle Dia.	No. of Bolt Holes	Bolt Size	Min. Bolt Length	Max. O.D.	Approx. Wt. (Lbs.)
856-005	1/2	1-3/4	29/32	17/32	2-3/8	4	1/2	2	3-1/2	.20
856-007	3/4	1-15/16	31/32	9/16	2-3/4	4	1/2	2	3-7/8	.29
856-010	1	2-3/16	1-1/32	5/8	3-1/8	4	1/2	2-1/4	4-1/4	.39
856-012	1-1/4	2-11/32	1-3/32	11/16	3-1/2	4	1/2	2-1/4	4-5/8	.50

Schedule 80 PVC Technical Information
PVC Pipe Flange Dimensions & Information



Flange Van Stone Style (continued)

(Two Piece)
 Spigot

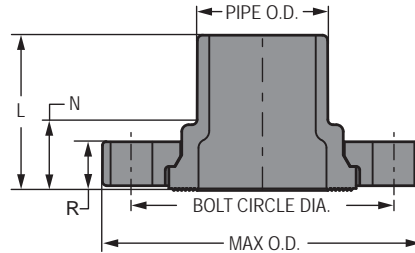

Part Number	Size	L	N	R	Bolt Circle Dia.	No. of Bolt Holes	Bolt Size	Min. Bolt Length	Max. O.D.	Approx. Wt. (Lbs.)
856-015	1-1/2	2-5/8	1-9/32	3/4	3-7/8	4	1/2	2-1/2	5	.60
856-020	2	2-7/8	1-11/32	13/16	4-3/4	4	5/8	3	6	.94
856-025	2-1/2	3-1/16	1-9/32	1	5-1/2	4	5/8	3-1/4	7	1.29
856-030	3	3-3/8	1-7/16	1-1/16	6	4	5/8	3-1/4	7-1/2	1.82
856-040	4	3-7/8	1-5/8	1-1/4	7-1/2	8	5/8	3-1/2	9	2.93
856-060	6	4-3/4	1-25/32	1-9/32	9-1/2	8	3/4	4	11	4.62
856-080	8	5-7/8	1-15/16	1-3/8	11-3/4	8	3/4	4-1/2	13-1/2	7.95
856-100	10	8	2-1/4	1-5/8	14-1/4	12	7/8	5	16	15.61
856-120	12	8-1/2	2-3/16	1-5/8	17	12	7/8	5	19	21.31



Flange Van Stone Style

with Multi-Bolt Pattern Ring
 (Two Piece)
 Spigot

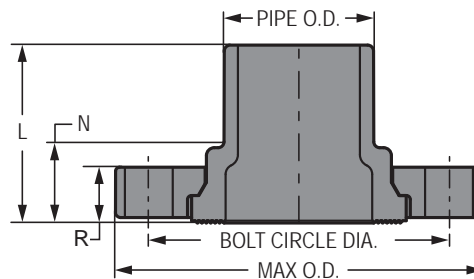

Part Number	Size	L	N	R	Bolt Circle Dia.		No. of Bolt Holes	Bolt Size	Max. O.D.	Approx. Wt. (Lbs.)
					Min.	Max.				
M856-020	2	2-7/8	1-11/32	13/16	4-1/2	4-15/16	4	5/8	6	.94
M856-060	6	4-3/4	1-25/32	1-9/32	9-7/32	9-1/2	8	3/4	11	4.77
M856-080	8	5-7/8	1-15/16	1-3/8	11-1/2	11-3/4	8	3/4	13-1/2	7.95



Schedule 80 PVC Technical Information

PVC Pipe Flange Dimensions & Information

Technical Information

Application

Fabricated IPS and PIP Flange fittings are coupling devices designed for joining IPS (Iron Pipe Size) or PIP (Plastic Irrigation Pipe) plastic piping systems, where frequent disassembly may be required. These flanges can be used as transitional fittings for joining IPS-to-IPS, PIP-to-PIP, IPS-to-PIP, or plastic to metal piping systems. Suitability of application is at the discretion of the user.

Pressure Rating

All standard fabricated flanges are Van Stone Style (except blind flange) — two piece design with rotating flange ring.

Class 150 IPS Flanges (with steel ring): 150 psi, water at 73°F.

IPS Flanges 18" - 24" (with plastic ring): 50 psi, water at 73°F.

IPS Flanges, Class 300 Bolt Pattern (with plastic ring): 1/2" - 16" 150 psi, 18" - 24" 50 psi, water at 73°F.

Blind Flanges, 14" - 24": 50 psi, water at 73°F.

PIP Flanges, 6" - 16" (with plastic ring & molded IPS flanges w/PIP Adapters): 125 psi, water at 73°F

PIP Flanges, 18" - 24" (with steel ring): 125 psi, water at 73°F



Flange Types

Van Stone Style Class 150 IPS (with steel ring) — Fabricated PVC body with steel flange ring, available in sizes 18" through 24", slip socket and 14" through 24", spigot.

Van Stone Style IPS (with plastic ring) — Fabricated PVC body with PVC flange ring, available in sizes 18" through 24", slip socket and 14" through 24", spigot.

Van Stone Style PIP (with plastic ring) — PIP adapter fabricated to injection molded PVC Van Stone Style IPS flange, available in sizes 6" through 16", slip socket.

Van Stone Style PIP (with steel ring) — Fabricated PVC body with steel flange ring, available in sizes 14" through 24", slip socket.

Blind — Closed ring design for capping off a mating flange; fabricated PVC available in sizes 5" and 14" through 24".

Special Note On PIP Flange Sizes

In order to facilitate connections between IPS and PIP systems, all Plastic Irrigation Pipe flanges are fabricated with PIP sockets using standard IPS Flange Rings. These are indicated in dimension tables under "Size" as (nominal IPS flange size) x (actual PIP O.D.), such as: 6" x 6.140".

To better meet user needs, Spears® offers flanges for 15.300" O.D. PIP with either 14" or 16" IPS Flange Rings. In addition, both 18.360" and 18.701" O.D. PIP are offered with 18" IPS Flange Rings.

Materials

All fabricated flanges are produced from PVC materials approved for potable water use by the National Sanitation Foundation (NSF®).

Steel flange rings are carbon steel.

Conformance Standards

Materials — ASTM D 1784 (PVC Cell Classification 12454-B).

Schedule 80 PVC Technical Information
PVC Pipe Flange Dimensions & Information



Weights & Dimensions

Specified minimum bolt lengths are based on the use of two Spears® Flanges, two standard flat washers, standard nut and 1/8" thick elastomer full face gasket. Mating with other brands or accessories may require variations.

Note: Bolts and gaskets are not supplied with flanges.

Dimension references:

- L** = Overall length of hub, ± 1/2 inch.
- M** = Outside diameter of socket hub, ± 1/4 inch.
- N** = (Laying Length) socket bottom to seal-ring face of flange, ± 1/2 inch.
- R** = Height (thickness) of flange ring, ± 1/16 inch.
- Max O.D** = Outside diameter of ring, ± 1/16 inch.
- Bolt Circle Diameter** = ANSI B16.5 Standard; ASTM D 4024, ± 1/16 inch.

Flange Van Stone Style PIP (with Plastic Ring)

Socket

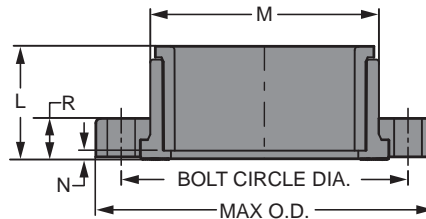

Part Number	Size	L	M	N	R	Bolt Circle Dia.	No. of Bolt Holes	Bolt Size	Min. Bolt Length	Max O.D.	Approx. Wt. (Lbs.)
354-060F	6x6.140	4-1/16	7-9/16	11/16	1-1/4	9-1/2	8	3/4	4	11-1/2	5.53
354-080F	8x8.160	4-15/16	9-3/8	9/16	1-1/2	11-3/4	8	3/4	4-1/2	13-5/8	8.30
354-100F	10x10.200	6-1/4	11-3/4	1	1-5/8	14-1/4	12	7/8	5	16	14.49
354-120F	12x12.240	7-5/16	13-13/16	1-1/16	1-5/8	17	12	7/8	5	19	21.59
354-151F	16x15.300	8-11/16	17-3/4	11/16	2-3/8	21-1/4	16	1	6-1/2	23-1/2	66.06

Flange Van Stone Style PIP (with Plastic Ring)

Socket

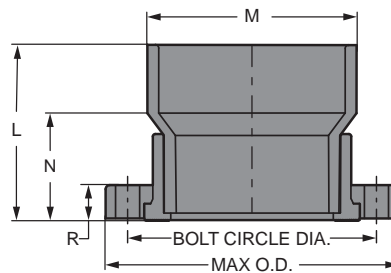

Part Number	Size	L	M	N	R	Bolt Circle Dia.	No. of Bolt Holes	Bolt Size	Min. Bolt Length	Max O.D.	Approx. Wt. (Lbs.)
354-150F	14x15.300	19-5/16	16-3/16	10-5/16	2	18-3/4	12	1	5-1/2	21	47.29



Schedule 80 PVC Technical Information
PVC Pipe Flange Dimensions & Information

Flange Van Stone Style PIP

(with Steel Ring)

Socket

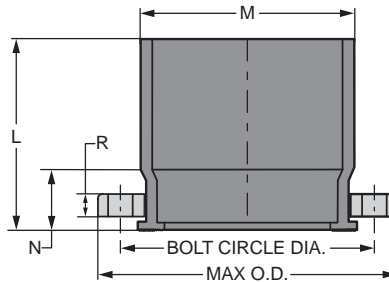

Part Number	Size	L	M	N	R	Bolt Circle Dia.	No. of Bolt Holes	Bolt Size	Min. Bolt Length	Max O.D.	Approx. Wt. (Lbs.)
354-181F	18x18.701	15-1/8	19-13/16	6-1/8	1/2	22-3/4	16	1-1/8	3	25	53.80
354-182F	18x18.360	11-5/8	19-1/2	5-5/8	1/2	22-3/4	16	1-1/8	3	25	53.80
354-200F	20x20.400	11-3/8	21-9/16	5-3/8	1/2	25	20	1-1/8	3	27-1/2	63.06
354-201F	20x22.047	16-9/16	23-1/4	6-9/16	1/2	25	20	1-1/8	3	27-1/2	64.43
354-241F	24x24.803	19-7/8	26-3/16	7-7/8	1/2	29-1/2	20	1-1/4	3	32	90.50

Blind Flange

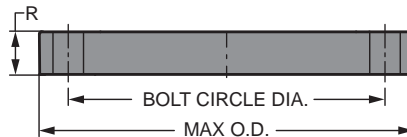

Part Number	Size	R	Bolt Circle Dia.	No. of Bolt Holes	Bolt Size	Min. Bolt Length	Max. O.D.	Approx. Wt. (Lbs.)
853-050F	5	1	8-1/2	8	3/4	4-1/8	10-1/16	3.63
853-140F	14	1-1/2	18-3/4	12	1	4-1/8	21	27.50
853-160F	16	1-1/2	21-1/4	16	1	4-1/8	23-1/2	33.83
853-180F	18	1-1/2	22-3/4	16	1-1/8	4-1/8	25	39.52
853-200F	20	1-1/2	25	20	1-1/8	4-1/8	27-1/2	47.67
853-240F	24	1-1/2	29-1/2	20	1-1/4	5-1/2	32	61.96

Schedule 80 PVC Technical Information
PVC Pipe Flange Dimensions & Information



Flange Van Stone Style IPS

(with Plastic Ring)

Socket

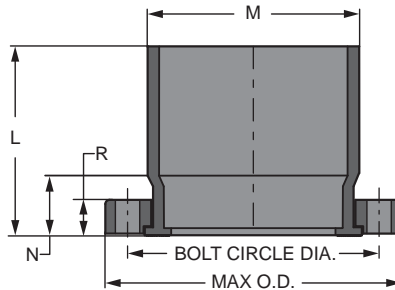

Part Number	Size	L	M	N	R	Bolt Circle Dia.	No. of Bolt Holes	Bolt Size	Min. Bolt Length	Max O.D.	Approx. Wt. (Lbs.)
854-180FP	18	15	19-1/8	6	1-1/2	22-3/4	16	1-1/8	4-1/8	25	36.09
854-200FP	20	16	21-3/16	6	1-1/2	25	20	1-1/8	5-1/2	27-1/2	55.09
854-240FP	24	19	25-3/8	7	1-1/2	29-1/2	20	1-1/4	5-1/2	32	80.93



Flange Van Stone Style IPS

(with Steel Ring)

Socket

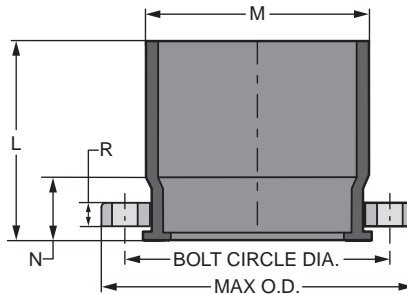

Part Number	Size	L	M	N	R	Bolt Circle Dia.	No. of Bolt Holes	Bolt Size	Min. Bolt Length	Max O.D.	Approx. Wt. (Lbs.)
854-120FS	12	9-5/8	13-9/16	3-3/8	1/2	17	12	7/8	3	19	---
854-140FS	14	11	14-7/8	4	1/2	18-3/4	12	1	3	21	---
854-160FS	16	13-1/2	17	5-1/2	1/2	21-1/4	16	1	3	23-1/2	---
854-180FS	18	14	19-1/8	5	1/2	22-3/4	16	1-1/8	3	25	49.30
854-200FS	20	15	21-3/16	5	1/2	25	20	1-1/8	3	27-9/16	65.00
854-240FS	24	18	25-3/8	6	1/2	29-1/2	20	1-1/4	3	32	86.15



Schedule 80 PVC Technical Information
PVC Pipe Flange Dimensions & Information

Flange Van Stone Style Class 300

(with Plastic Ring)

Socket

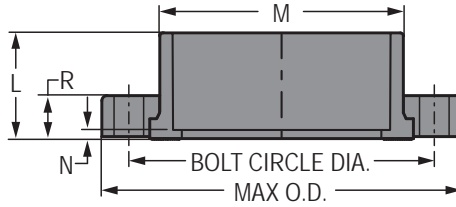

Part Number	Size	L	M	N	R	Bolt Circle Dia.	No. of Bolt Holes	Bolt Size	Min. Bolt Length	Max O.D.
854-005CL300	1/2	1	1-3/16	3/16	1/2	2-5/8	4	1/2	2	3-3/4
854-007CL300	3/4	1-1/8	1-3/8	3/16	1	3-1/4	4	5/8	3-1/2	4-5/8
854-010CL300	1	1-1/4	1-3/4	3/16	1	3-1/2	4	5/8	3-1/2	4-7/8
854-012CL300	1-1/4	1-3/8	2-1/8	1/8	1	3-7/8	4	5/8	3-1/2	5-1/4
854-015CL300	1-1/2	1-1/2	2-7/16	3/16	1	4-1/2	4	5/8	3-1/2	6-1/8
854-020CL300	2	1-11/16	2-15/16	3/16	1	5	8	5/8	3-1/2	6-1/2
854-025CL300	2-1/2	2	3-9/16	1/4	1	5-7/8	8	3/4	3-1/2	7-1/2
854-030CL300	3	2-1/8	4-1/4	1/4	1	6-5/8	8	3/4	3-1/2	8-1/4
854-040CL300	4	2-1/2	5-1/4	1/4	1-1/2	7-7/8	8	3/4	4-1/2	10
854-060CL300	6	3-7/16	7-9/16	3/8	1-1/2	10-5/8	12	3/4	4-1/2	12-1/2
854-080CL300	8	4-3/8	9-3/8	5/16	1-1/2	13	12	7/8	4-1/2	15
854-100CL300	10	5-11/16	11-3/4	5/8	1-1/2	15-1/4	16	1	4-1/2	17-1/2
854-120CL300	12	7-5/16	13-13/16	9/16	1-1/2	17-3/4	16	1-1/8	4-1/2	20-1/2
854-140CL300	14	7-9/16	15-9/16	9/16	2	20-1/4	20	1-1/8	5-1/2	23
854-160CL300	16	8-9/16	17-3/4	9/16	2	22-1/2	20	1-1/4	6	25-1/2

Flange Van Stone Style Class 300

(with Plastic Ring)

Socket

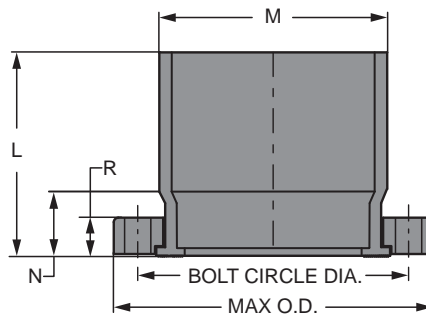

Part Number	Size	L	M	N	R	Bolt Circle Dia.	No. of Bolt Holes	Bolt Size	Min. Bolt Length	Max O.D.	Approx. Wt. (Lbs.)
854-180CL300	18	15	19-1/8	6	2	24-3/4	24	1-1/4	6	28	61.11
854-200CL300	20	15-1/4	21-3/16	5-1/4	2	27	24	1-1/4	6	30-1/2	68.38
854-240CL300	24	19	25-3/8	7	2	32	24	1-1/2	6	36	134.51

Schedule 80 PVC Technical Information
PVC Pipe Flange Dimensions & Information



Flange Van Stone Style IPS

(with Plastic Ring)

Spigot

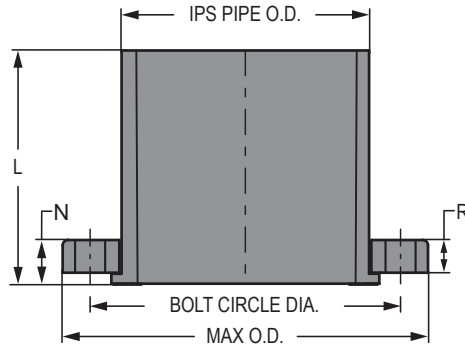

Part Number	Size	L	N	R	Bolt Circle Dia.	No. of Bolt Holes	Bolt Size	Min. Bolt Length	Max O.D.	Approx. Wt. (Lbs.)
856-140FP	14	15-5/16	7-3/4	2	18-3/4	12	1	5-1/2	21	24.00
856-160FP	16	17-13/16	8-9/16	2-3/8	21-1/4	16	1	6-1/2	23-1/2	61.83
856-180FP	18	19-9/16	9-9/16	2-3/8	22-3/4	16	1-1/8	6-1/2	25	34.81
856-200FP	20	13	2-1/16	1-1/2	25	20	1-1/8	5-1/2	27-1/2	42.50
856-240FP	24	16-3/8	2-1/8	1-1/2	29-1/2	20	1-1/4	5-1/2	32	68.00

Flange Van Stone Style IPS

(with Steel Ring)

Spigot

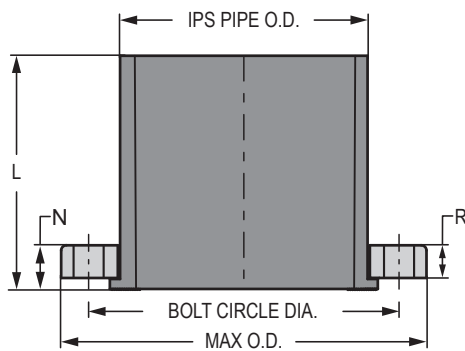

Part Number	Size	L	N	R	Bolt Circle Dia.	No. of Bolt Holes	Bolt Size	Min. Bolt Length	Max O.D.	Approx. Wt. (Lbs.)
856-140FS	14	10	15/16	1/2	18-3/4	12	1	3	21	36.63
856-160FS	16	11	1	1/2	21-1/4	16	1	3	23-1/2	46.50
856-180FS	18	12	1-1/16	1/2	22-3/4	16	1-1/8	3	25	47.27
856-200FS	20	13	1-1/16	1/2	25	20	1-1/8	3	27-1/2	59.00
856-240FS	24	15-3/8	1-1/8	1/2	29-1/2	20	1-1/4	3	32	84.00