

# Power

Corrosion resistant solutions for worldwide Power industries



# About Plasticon Composites

Plasticon Composites is a full-service turnkey solution provider in the field of corrosion resistant glassfibre reinforced plastic (GRP) tanks, piping and apparatus. Founded in 1950 Plasticon Composites is well positioned to meet your needs.

Plasticon Composites is the world's largest manufacturer of specially engineered, corrosion resistant, fibreglass reinforced plastics and dual laminate products providing integrated solutions for the handling, storage and processing of critical fluids and gases for the chemical, water & wastewater, power generation and other process industries. Dual laminate constructions consist either of thermoplastic or fluoropolymer liners reinforced with GRP.

Plasticon Composites is an international specialist in design, manufacturing, installation and service solutions for the processing, storage and transport of highly critical corrosive fluids and gasses. The products are constructed from high quality composite materials. Plasticon Composites has a consolidated geographical presence, with a multi-lingual staff and an active research and development programme. Our technical support team of specialists assists customers in the early planning and design stages of projects. Plasticon Composites aims to reach an optimum end-result with solutions that reduce operational costs for its customers. Composite structures by Plasticon Composites come in a wide variety of materials, sizes, shapes and forms, depending on process specifications. The versatility of working with today's composites, combined with the Plasticon Composites expertise, results in an extensive range of integrated solutions.

Plasticon Composites, leader in anti-corrosion applications and composite solutions



Transport of big diameter GRP cylinders to Germany in 1963



Transport of horizontal PVC/GRP tanks for a chemical plant in the Netherlands in 1959

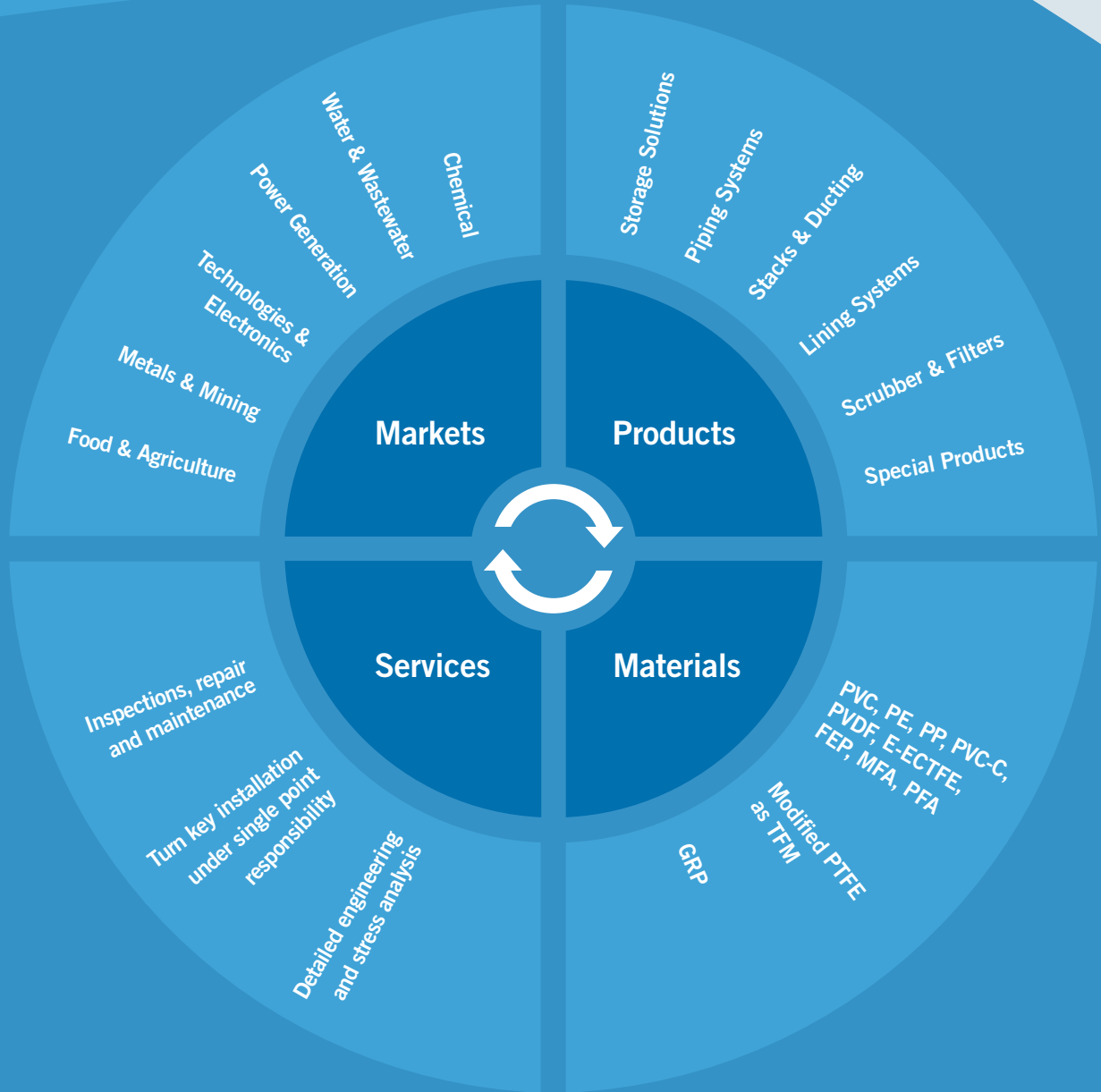

Duct D = 10 meter, L = 150 meter in a cooling tower at a coal fired power plant



GRP silos (6 x 500 m3 D = 5000 mm)

Lifting of a GRP chimney liner shell of  
D = 6 meter, H = 120 meter at a new  
build coal fired power plant



# Specialist in Power & Waste Incineration Plants

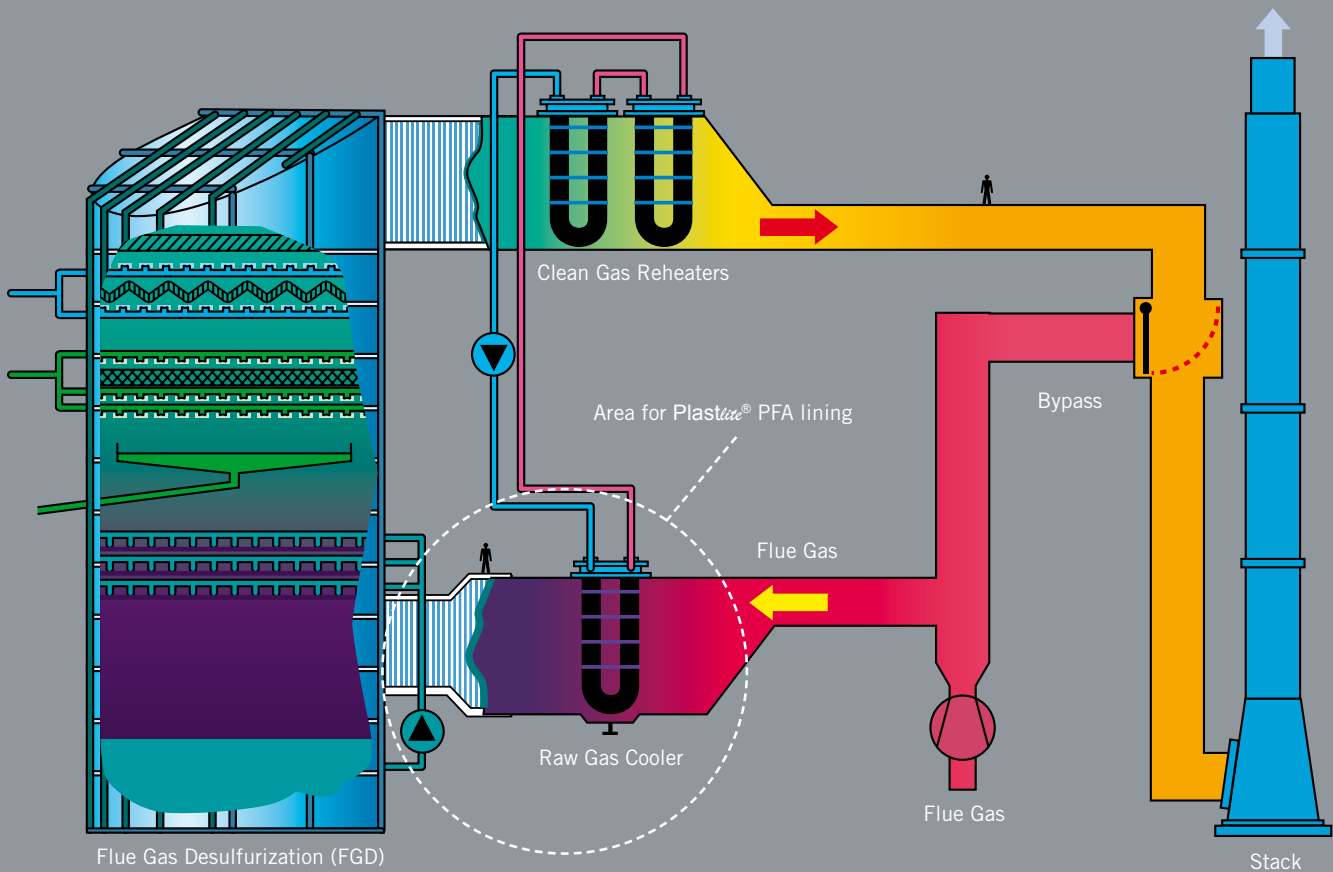

Flue Gas Desulfurization (FGD)

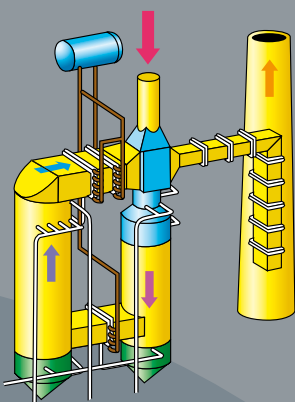

Over the years Plasticon Composites has proved to be an expert in the design, engineering, manufacture, transport and installation according to all the international standards such as:

- ASME
- ASTM
- AD Merckblatt
- BS
- DiBT
- DIN
- KIWA
- AWWA
- VIC

Plasticon Composites offers the following equipment for Flue Gas Desulphurisation (FGD) processes:

- Scrubbers
- Spray banks
- Recycle piping
- Auxiliary piping
- Cooling water piping
- Storage tanks
- Ducts
- Chimney liners
- Stacks
- Fluoroplastic lining

# Field Fabrication & Installation

Plasticon Composites can produce on site when the transport of our products is not possible due to size and transport methods. The climate at the site is not an issue, Plasticon Composites already has experience working at temperatures from -40 °C to +50 °C.

Plasticon Composites has designed highly sophisticated winding machines and a mobile plant especially for the manufacture of Fibreglass stacks, ducts, apparatus and vessels on site. Depending on the diameter Plasticon Composites uses its vertical winding machine for diameters up to 20 metres and its horizontal winding machine for diameters up to 16 metres. The mechanical properties of the laminate produced with the on-site winding equipment are exactly the same as the properties of the laminate in the different production facilities.



The vertical winding machine for products up to 20 meter



An overview of the mobile factory for products up to 16 meter



The highly sophisticated winding machine developed by Plasticon Composites



Lifting of a cylinder of  $D = 10$  meter from the mobile winding factory

GRP chimney liner in a concrete stack  
D = 5 meter H = 180 meter

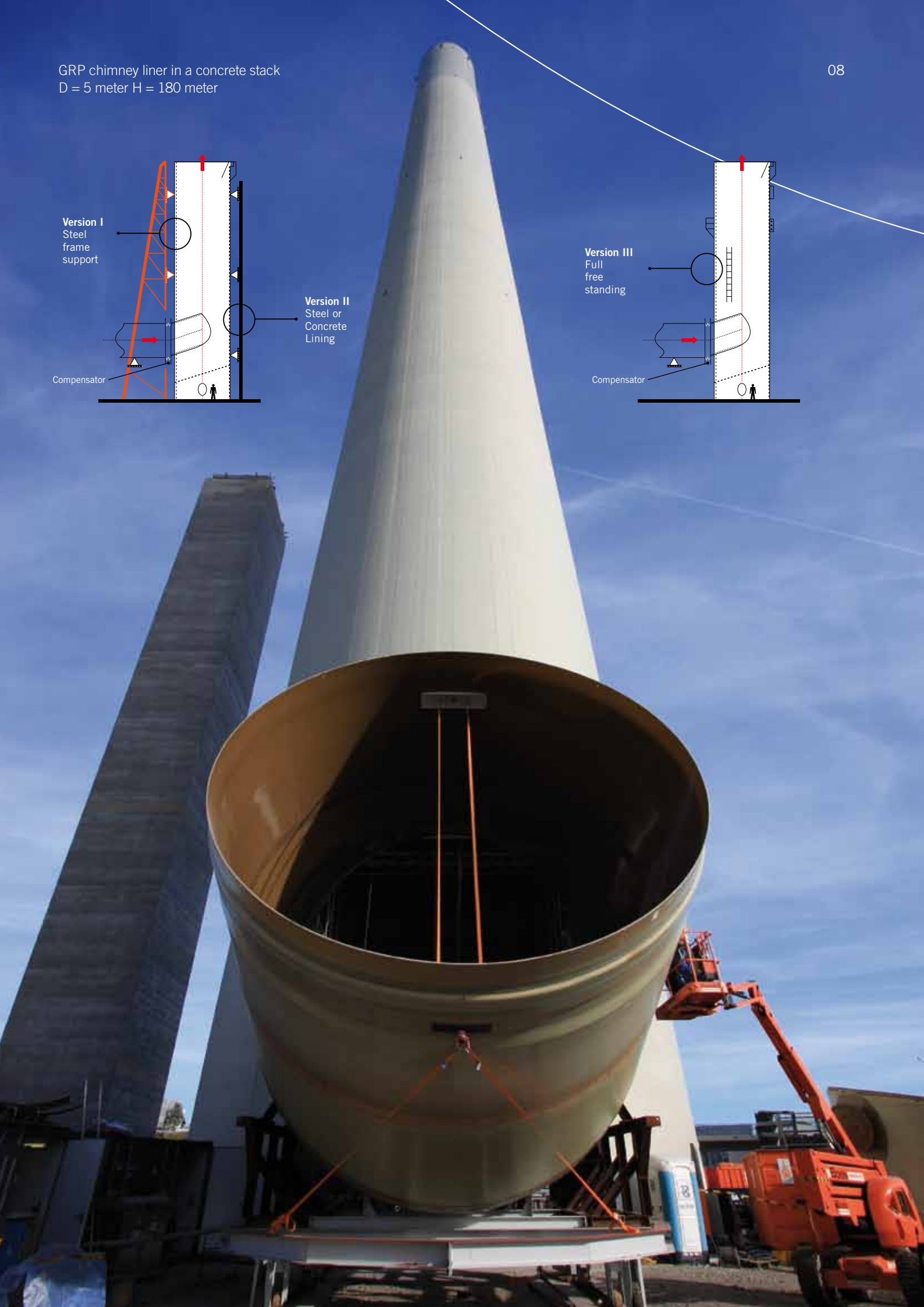



# Stacks & Chimneys

Over the years Plasticon Composites has proved to be an expert in the design, engineering, manufacture and installation of stacks, liners and chimneys up to 10 metres.

The need for these products is growing rapidly as process demands are increasing, requiring more corrosion resistant solutions. Plasticon Composites manufactures the following types:

1. Steel frame supported GRP stack/chimney
2. GRP liners for concrete and steel stacks
3. Full free standing GRP stacks

Equipment Options:

- Ladders
- Platforms
- Bridges
- Aviation lights
- Condensate drainage
- Protection against electrostatic discharge



A steel supported GRP stack of 10.2 meter on top of an absorber

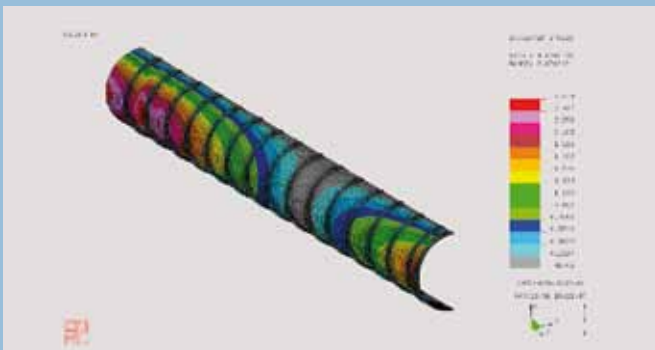

An analysis of the bending characteristics of a 10 meter diameter duct by the Finite Element Method (FEM)

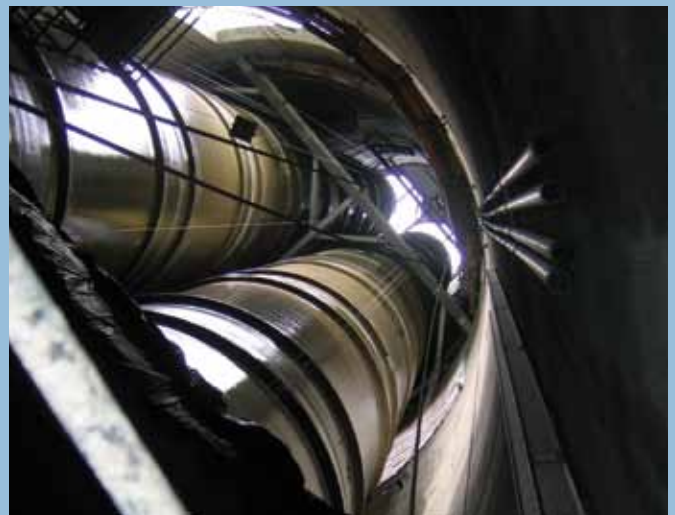

Two chimney liners installed in a concrete stack with a height of 150 meter

# Ducting

Plasticon Composites is able to design, supply, assemble and install ducts at power plants. We are familiar with providing ducts to the power market, including for the FGD and CSS Processes. Ducts can be manufactured on site or in one of our workshops. We assemble ducts from the absorber to the chimney or cooling water tower. Besides ducts, Plasticon Composites also provides:

1. 90° Elbow with internal vanes
2. Segmented elbow
3. Transition pieces

Equipment options:

- Ladders
- Platforms
- Condensate drainage
- Protection against electrostatic discharge
- Manholes

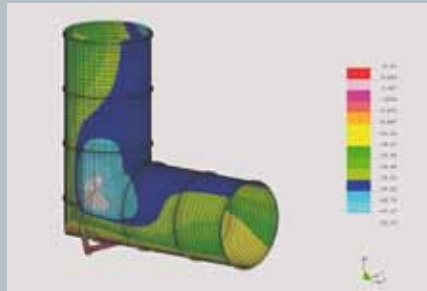

An analysis of the bending characteristics of a 10 meter diameter elbow by the Finite Element Method (FEM)



Lifting of a 10 meter diameter duct in a cooling water tower



Inspection of a 10 meter diameter duct by our well experienced QA personnel



Special transport of a 150 ton duct part from the mobile factory to the site

3 tanks of 500 m<sup>3</sup> D = 8 meter of the storage of lime stone solution



# Storage Solutions

Plasticon Composites offers a wide variety of solutions to store fluids or bulk materials. These solutions are made of full GRP or dual laminate materials. The choice of material makes Plasticon Composites storage tanks easy to install in different environments. From experience we know that every application has its own specific requirements. Plasticon Composites storage solutions include detail engineering, manufacturing, transportation and installation of all components.

Our production sites are equipped with the latest technology. With workshops located around the world and our 'on site winding unit', Plasticon Composites can adapt to all local requirements. We manufacture up to 10 metres in our shops and up to 20 metres on your site with one of our 'on site winding plants'.

Our storage solutions are designed according to all international standards up to 10 metres Ø. We offer the following solutions:

1. Process vessels
2. Vertical tanks with flat or dished bottoms
3. Horizontal tanks above or underground

Our storage solutions can be equipped with:

- Railing and ladders
- Platforms or anti slip (or skid) layers
- Bridges
- Agitators
- Insulation and heat tracing systems
- Reinforcement / vacuum rings
- Level indicators
- Steel or GRP supports
- Double wall construction or constant monitoring on the tank (PDS)



Inspection opening D = 800 mm in large diameter tanks



The production of a 1000 m<sup>3</sup>, 9.5 meter tank in one of our production facilities



Loading of two tanks of 1000 m<sup>3</sup> for delivery to the Far East by sea transport

# Scrubbers

The gas cleaning process, controlling gaseous emissions, especially polluted gases, is an important part of waste incineration or power generation processes. Plasticon Composites scrubbers can be used for the removal of  $\text{SO}_x$ ,  $\text{NO}_x$ , HF and HCl.

Plasticon Composites scrubbers function simply and efficiently. Plasticon Composites designs the perfect scrubber for your application based on the requirements of the chemical engineering company. The design is mostly based on requirements regarding temperature, gas flow, pressure, earthquake and climate conditions.  $\text{CO}_2$  recovery is also one of the areas that Plasticon Composites is involved in.

Plasticon Composites delivered the scrubbers for one of the pilot  $\text{CO}_2$  recovery plants in Norway.

As a full service supplier, Plasticon Composites designs, produces and installs equipment for the exterior of a scrubber such as ladders, platforms, drainage, protection liner and electrostatic discharge but also has the facility to serve you by delivering all internals such as spray banks, support beams, mist filters and packing.



Transport of a GRP scrubber of D = 4 meter for a waste incineration plant in Germany



Lifting of a scrubber of D = 5 meter, H = 30 meter for an waste incineration Plant in Germany



A scrubber of D = 3.5 meter cleaning Hydrochloride acid gasses

Absorber D = 7.6 meter with chimney  
D = 3 meter and H = 60 meter for a  
power plant in the Middle East



# Piping Systems

## GRP Piping Systems

Since 1969 Plasticon Composites has enjoyed a worldwide reputation in glassfibre reinforced pipes and fittings with its Kialite® brand and Plastilon® brand (bell & spigot bonding system) piping systems. Today, piping systems are available in a variety of standard diameters ranging from 25 to 1200 mm. Plasticon Composites offers pipe and fittings to meet all national and international standards depending on the area and application. Combining the strength of GRP and the chemical compatibility of plastics provides customers with a superior alternative to costly metal alloys and rubber-lined steel.

## Applications:

- Industrial cooling water
- Chemical processing
- Flue gas desulphurisation
- Food processing
- Ship building
- Fire fighting installations
- Water purification
- Sewage treatment

## Dual Laminate Piping Systems

In addition, Plasticon Composites manufactures and installs PVC lined GRP pipes for aggressive products such as chlorine gas, hydrochloric acid, sodium hypochlorite and caustic soda. Various thermoplastic and fluoropolymer liners were combined by Plasticon Composites (PVC, C-PVC, PP, PE, PVDF, E-CTFE, FEP, PFA, MFA) with glassfibre reinforced polyester resins to provide customers with dual laminate piping systems for extremely hot and corrosive environments.

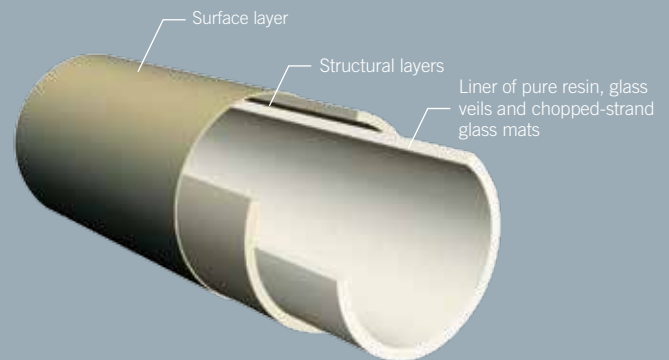
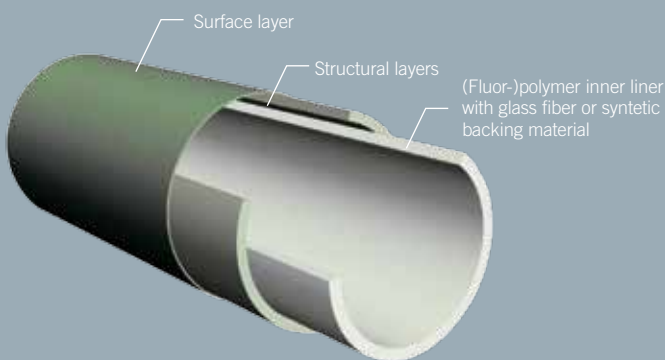

Fully automatized winding machine



Fully robotized production of a GRP elbow (D < 1200 mm)



**Figure 1: Hot gas weld**

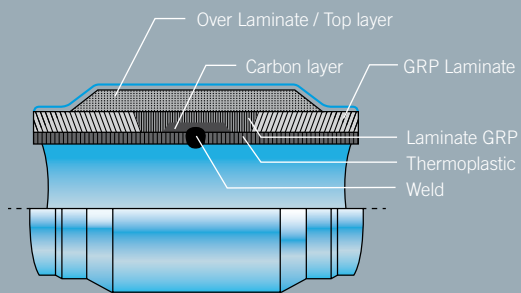

**Figure 2: Butt fusion weld**

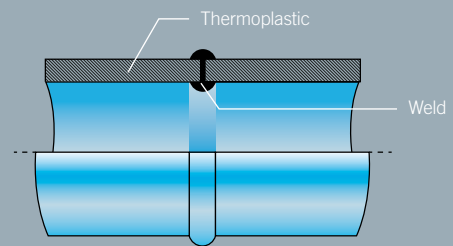

**Figure 3: Butt & strap lamination joint**

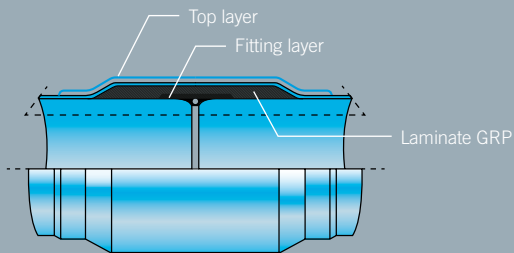

**Figure 4: Bell & Spigot adhesive joint**

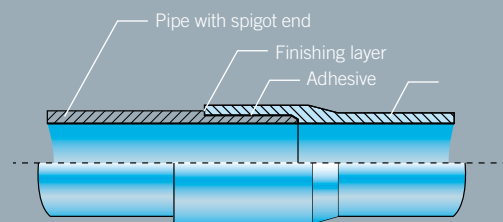

**Figure 5: Flange joint**

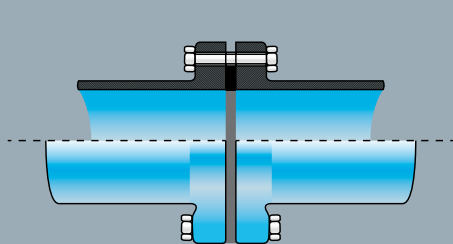

**Figure 6: Mechanical O-ring joint (available with locking key or unrestrained)**

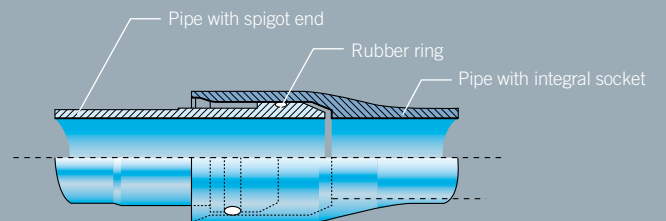

The proper storage of small diameter GRP pipes



Quality inspection of GRP recirculation piping on an absorber (D = 1200 mm, P = 10 bar)



GRP piping at a power plant in Germany

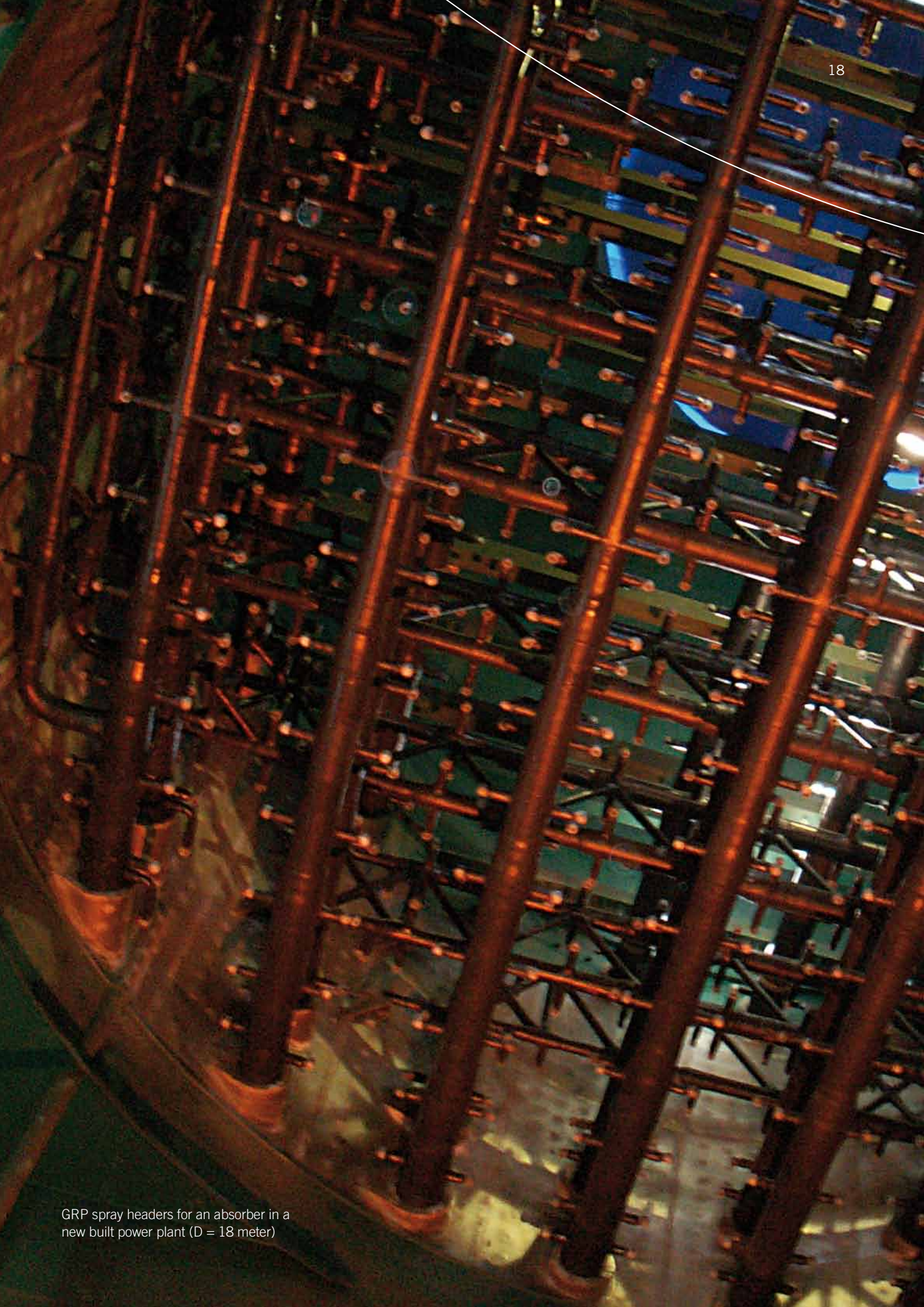

GRP spray headers for an absorber in a new built power plant (D = 18 meter)

# Spray Systems

An important part of the scrubber and gas cleaning process in the power industry is the spray system. On the one hand, Plasticon Composites supplies spray systems for existing plants and the replacement of former spray systems, on the other hand we supply scrubbers including installed spray systems. Our spray systems are composed of different combinations of corrosion resistant and long lasting material.

Plasticon Composites manufactures spray systems with the following materials:

- Full GRP
- Full GRP protected by thermoplastic or fluoroplastic
- PP/GRP
- PP

In abrasive conditions the spray headers can be constructed with a PP or silicium carbide protection layer. The spray systems can be designed and manufactured in a wide range of diameters. Depending on the construction, Plasticon Composites offers supported or unsupported systems. We are also experienced in designing main headers with integrated support beams.

Important components in the design of spray systems are the nozzles and nozzle connections. We offer different options for assembling the nozzles; we are experienced in: bonded, laminated, flanged, threaded and clamped connections.



GRP spray headers



GRP spray header with a anti abbrasive protection layer on the top

# Fixpoint Linings

## Lining Systems

Plasticon Composites is recognized as a leading supplier in the field of fluoropolymer linings for a variety of applications in the pharmaceutical, chemical, semi-conductor, power generation, waste incineration, biotechnology and processing industries. Our lining products are characterized by outstanding chemical resistance, compatibility to both high and low temperatures, high pressure ratings and corrosion resistance. Fluoropolymer liners such as PVDF, E-CTFE, FEP, MFA, PFA and modified PTFE (e.g. TFM) can be employed as dual laminate, sheet lining, loose lining and fix point lining.

## Fix point lining

Plasticon Composites offers a new technique of a fix point lining system, so-called **Plastite** by transmission welding. The principle of the basic transmission welding method is that high energy light is transmitted through the transparent fluoroplastic liner. On the backside, the light hits the absorbing (black) surface of the fix point, where the light energy is transformed into heat. In this contact area, a conventional welding process based on heat, pressure, and time takes place. Based on this method, we have created a modular system of different fix point linings, which enables us to solve individual problems in any application.

This system offers the highest level of corrosion protection: a double wall lining with a ventilation and inspection space, where a spacer net guarantees a free flow of ventilation air. The ventilation system can also be used to build up a vacuum to act as an additional fixation for the inner liner.

The Plasticon Composites fix point lining system has been tested at 250°C and 50 bar negative pressure and approved as the best system for lining heat exchangers in highly corrosive environments (HCl and HSO<sub>4</sub>).

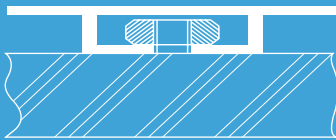

Plain **Plastite** Fixpoint



Curved **Plastite** Fixpoint

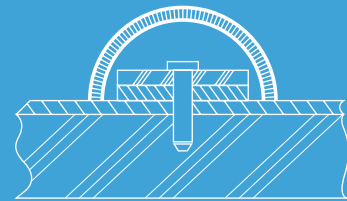

Conventional caps; Welded by hot gas



Plasticon Composites even is able to produce a liner in complex constructions



Application of plain **Plastite** fixpoint

Fix point lining of the inlet of a huge heat exchanger (T = 220°C)

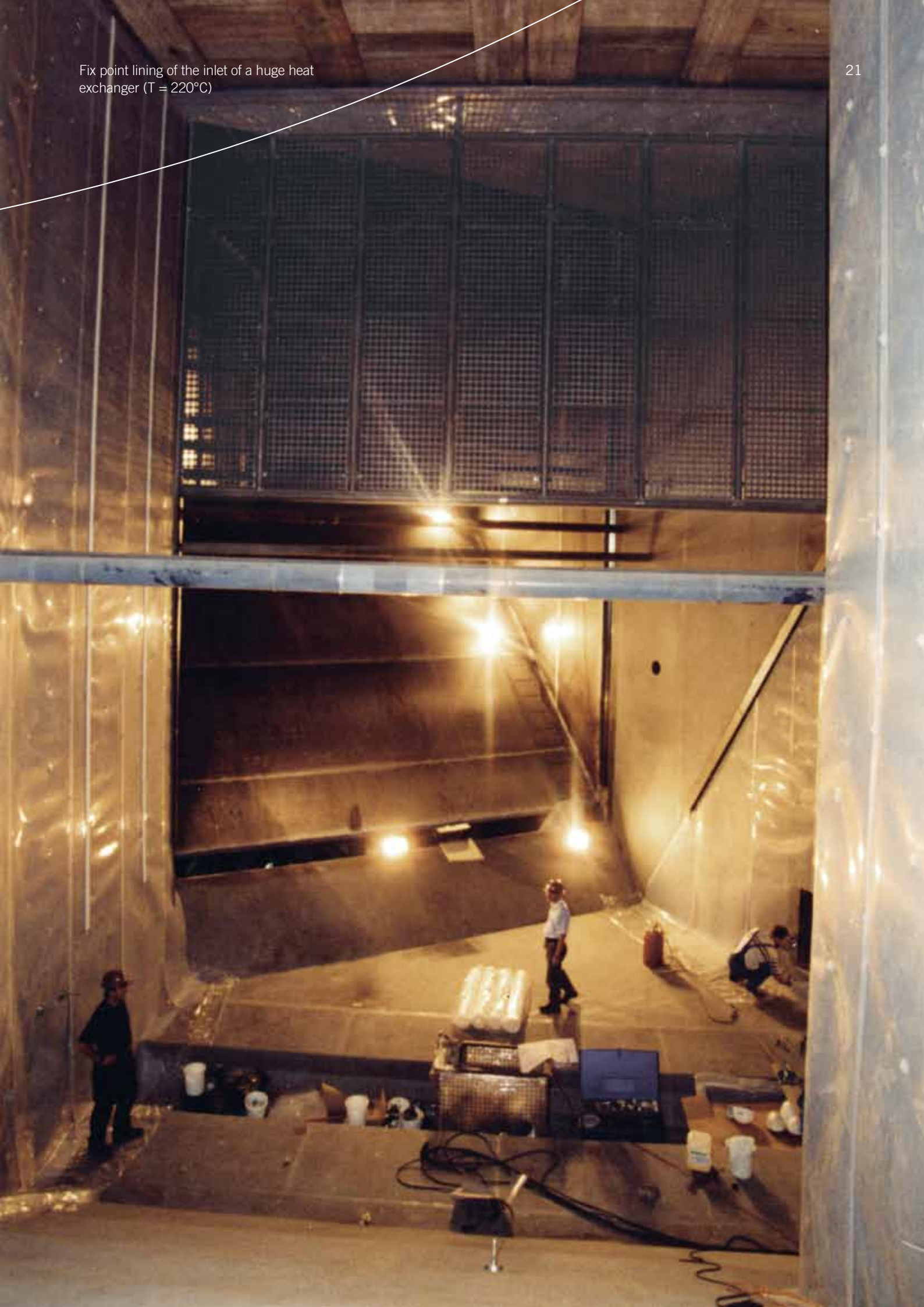

# Full Service Provider

Plasticon Composites has the capability to design, manufacture, install and service GRP and dual laminate products for your specific needs. An experienced, multi-lingual staff consisting of our team of engineers and technical support specialists assist customers in the early planning and design stages. The end result is an engineered system that reduces life cycle cost.

## Maintenance services

Plasticon Composites recommends periodic upgrades and maintenance for the optimum performance of composite systems in extreme environments. To minimise downtime and avoid unplanned interruptions, Plasticon Composites offers the following maintenance services:

- Inspections
- Refurbishments
- Preventive Maintenance
- Facility Upgrades
- Repairs



Safety check by our HSE staff



New employees in the training centre of Plasticon Composites



Quality inspection by our well experienced quality staff

#### Continuous training

Plasticon Composites realises that an investment in training is critical to the company's long-term leadership position in the field of engineered composite systems.

Two areas of focus for the company include:

#### - In-House Training

Plasticon Composites acknowledges that many of the best ideas are generated by our employees. Product training sessions are a part of day-to-day business and best practices and are encouraged so that Plasticon Composites can offer customers the very best service and product.

#### - Certified Laminators and Thermoplastic Welders

Plasticon Composites exceeds industry requirements for certified GRP laminators and thermoplastic welders through its in-house training programme. This is in addition to the annual testing and inspections performed by well-known organisations such as KIWA and DVS.

#### Industry Technical Associations

Plasticon Composites maintains active membership of many technical associations throughout the world in order to stay abreast of changing technologies and pending regulations.

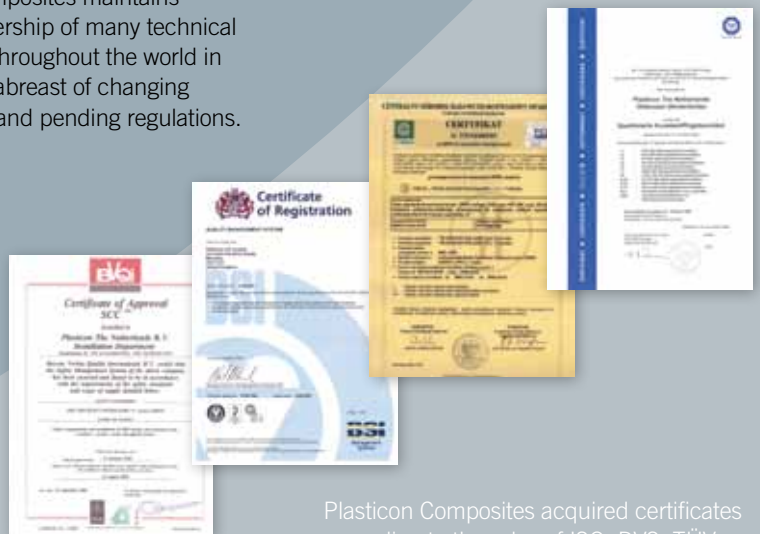

Plasticon Composites acquired certificates according to the rules of ISO, DVS, TÜV, KIWA, Veritas and IFBT



Installation of a thermoplastic (PE) pipe

- Operations & Sales
- Sales
- Polem, bulk storage

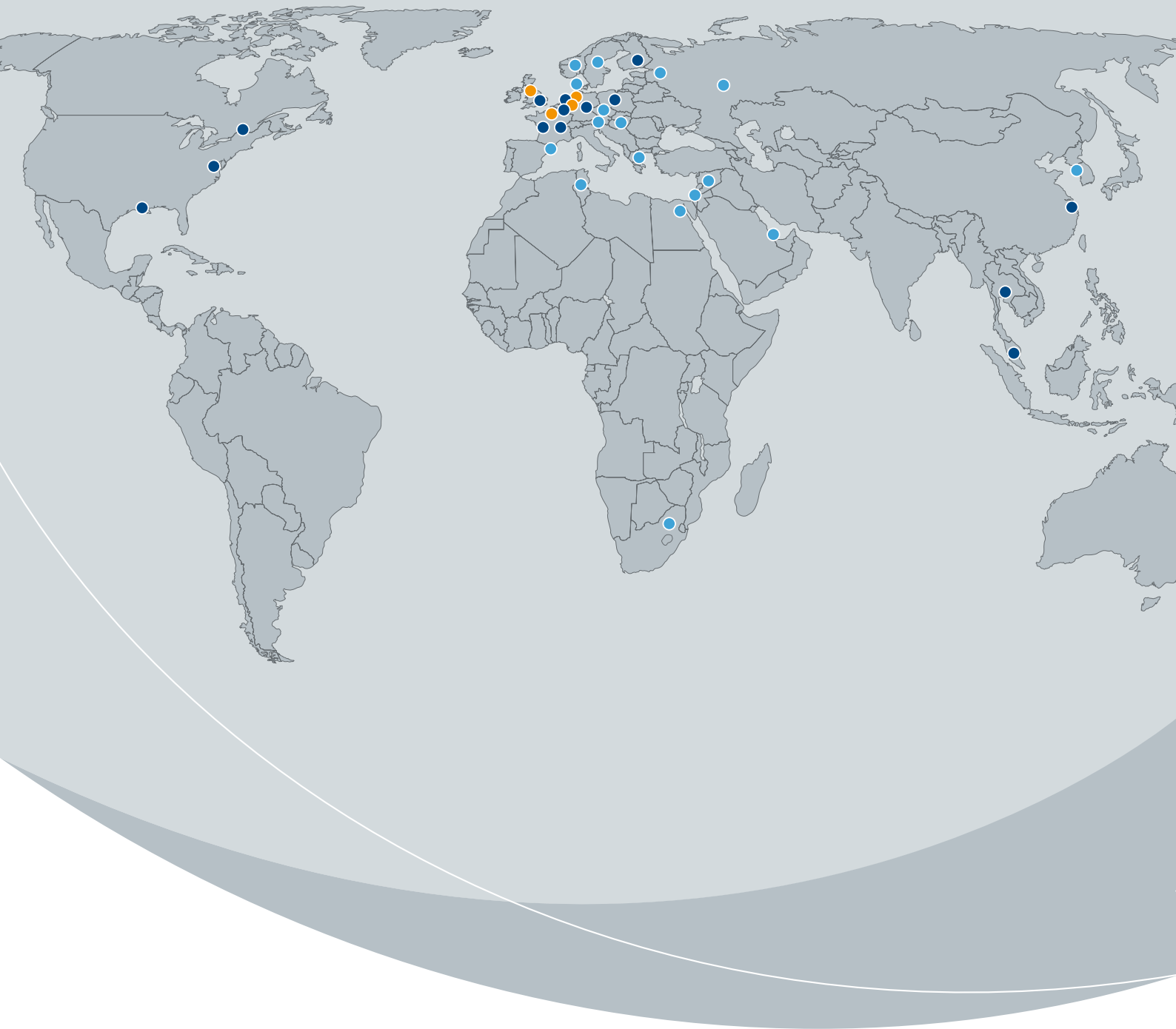

General

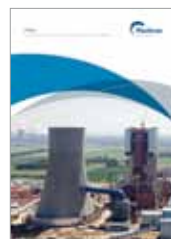

Power



Piping Systems



Chemical